

VOLUME 11

OTR TIRES

 **TITAN**



> **TITAN HK 458** (LEFT)

A new, deep-tread, directional, pattern designed to provide greater traction for the most extreme wheel loader conditions

> **TITAN SM 150** (RIGHT)

Deep tread, solid center and large contact area provide damage resistance and long tread life

> CONTENTS

Intro to OTR Tires

- Tire Construction: Radial & Bias 2
- Compound/Construction of OTR Tires 3
- Dimension Definitions 3
- Sidewall Information: Radial & Bias 4
- Vehicle/TRA Coding 5
- Industry Standards & Tire Selection Chart 6
- Pressure Conversions 7
- Load Index/Speed Symbol 8
- Tire Inflation Guide 10
- OTR Product Application Guides 11

Titan OTR Tires..... 19

Load & Inflation Tables..... 67

OTR Tire Maintenance

- Tire Handling 155
- Tire Storage..... 155
- Inflation Pressure 156
- Measuring Tread Wear 157

Important Safety Information....S:1



TIRE CONSTRUCTION: RADIAL & BIAS

Radial Ply

Radial ply tires have a casing that consists of steel or nylon cords that run primarily in the radial direction (perpendicular to the tread centerline). They have belts that transfer the load from the casing to the tread and form the footprint.

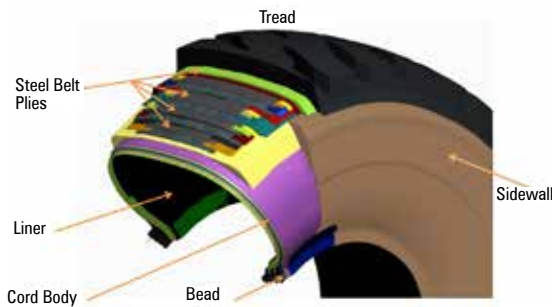

Bias Ply

Bias ply tires have a casing consisting of multiple plies of nylon cords that run at an angle from bead to bead (angled across the tread centerline). They can have breakers that act as protection under the tread.

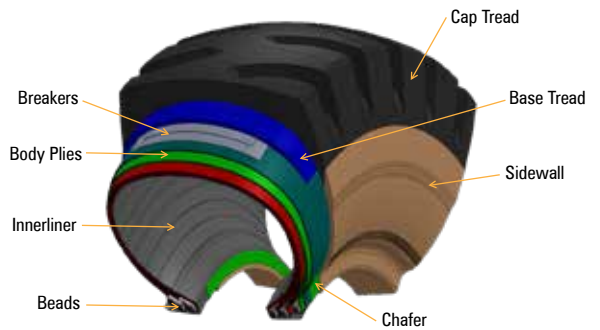

Footprint Profiles

Radial Footprint

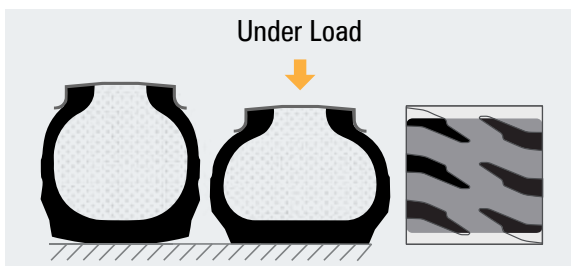

- Radial tire treads and sidewalls work **independently** allowing the footprint to lengthen and widen. Lugs remain stable through the footprint reducing the chance of rutting and minimizing soil compaction.
- Larger area of contact will contribute to less ground bearing pressure.

Bias Footprint

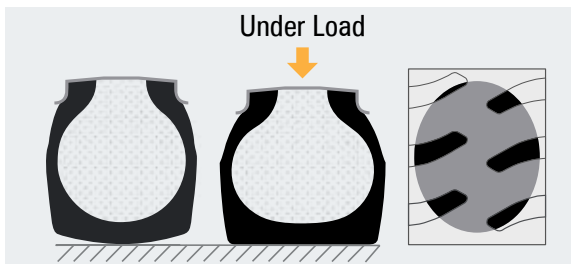

- Bias tire treads and sidewalls work **as one** causing lugs to move and squirm.
- Small area of contact will contribute to higher ground bearing pressure.

Advantages Comparison

Radial vs Bias

Advantages	Tire Design	
	Radial	Bias
Vehicle Steadiness (Stability)	<input type="checkbox"/>	<input checked="" type="checkbox"/>
Cut Resistance (Sidewall)	<input type="checkbox"/>	<input checked="" type="checkbox"/>
Ride (Comfort)	<input checked="" type="checkbox"/>	<input type="checkbox"/>
Traction	<input checked="" type="checkbox"/>	<input type="checkbox"/>
Wear (Service Life)	<input checked="" type="checkbox"/>	<input type="checkbox"/>
Self-Cleaning (Tread)	<input type="checkbox"/>	<input checked="" type="checkbox"/>
Puncture Resistance (Tread)	<input checked="" type="checkbox"/>	<input type="checkbox"/>
Repairability	<input type="checkbox"/>	<input checked="" type="checkbox"/>
Higher Speeds	<input checked="" type="checkbox"/>	<input type="checkbox"/>
Longer Distances	<input checked="" type="checkbox"/>	<input type="checkbox"/>
Belt Types: Nylon, Aralon**, or Steel Belts	<input type="checkbox"/>	<input checked="" type="checkbox"/>
Belt Types: Polyester, Aramid, or Steel Belts	<input checked="" type="checkbox"/>	<input type="checkbox"/>

*Aralon® is not a registered trademark of Titan International, Inc.

COMPOUND/CONSTRUCTION OF OTR TIRES

Radial	
Compound Designations	
Ultra Heat Resistant	S
Heat Resistant	H
Wear Resistant (Standard)	W
Cut Resistant	C
Underground Mining	UGM

Construction Description on Siped Tread Designs	
Siped Tread	D, E, G, R, V
Sipeless Tread	2, 4, 5, 7
Poly Belted	Polyester Belt Package
Steel Belted	Steel Belt Package

Bias	
Compound Designations	
Cut/Chip Resistant	VE-420
Wear Resistant on concrete/asphalt	VE-610
Underground Mining	UGM

Construction Description	
Aralon* Cut Resistant Breakers	CRB
Steel Cushion Armor Breakers	CAB
7x7 Steel Belted Breakers	7x7 Belted
Heavy Duty (additional Steel Breakers)	HD

*Aralon® is not a registered trademark of Titan International, Inc.

DIMENSION DEFINITIONS

Inflated Dimensions

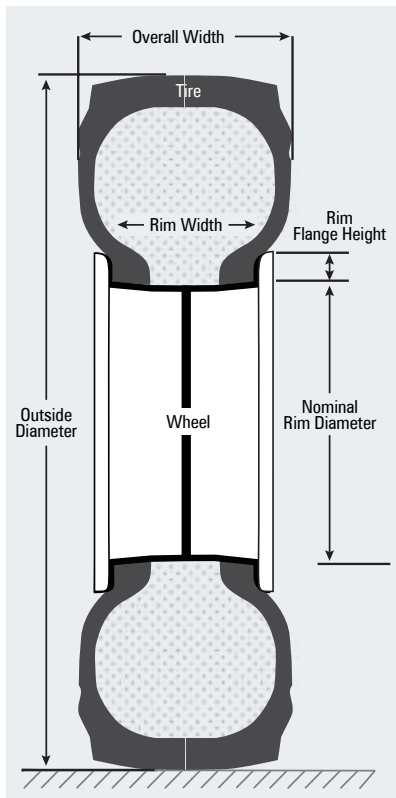

Loaded Dimensions

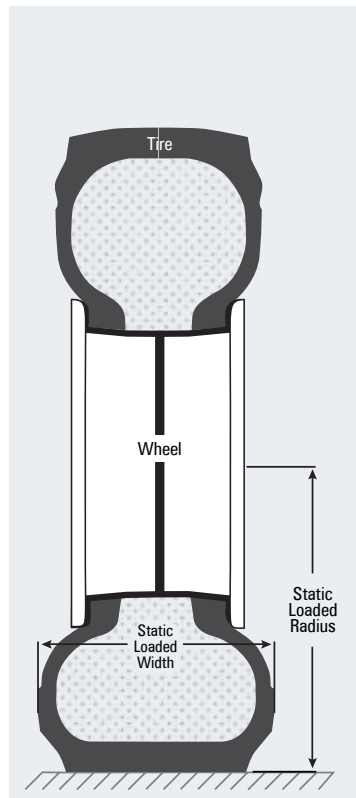

Definitions

Outside Diameter	Overall outside diameter of tire inflated to rated pressure. Dimension is with no load applied to tire.
Overall Width	Overall outside width of tire inflated to rated pressure. Dimension is with no load applied to tire.
Rim Width	Approved rim width
Rim Flange Height	Approved flange height
Static Loaded Width	Overall outside width of tire at rated load and inflated to rated pressure. Also known as Bulge Width
Static Loaded Radius	Distance from ground to center of the axle at rated load and inflated to rated pressure.
Flat Plate Area	Gross footprint area at rated load and rated pressure.

SIDEWALL INFORMATION: RADIAL & BIAS

Radial Tires

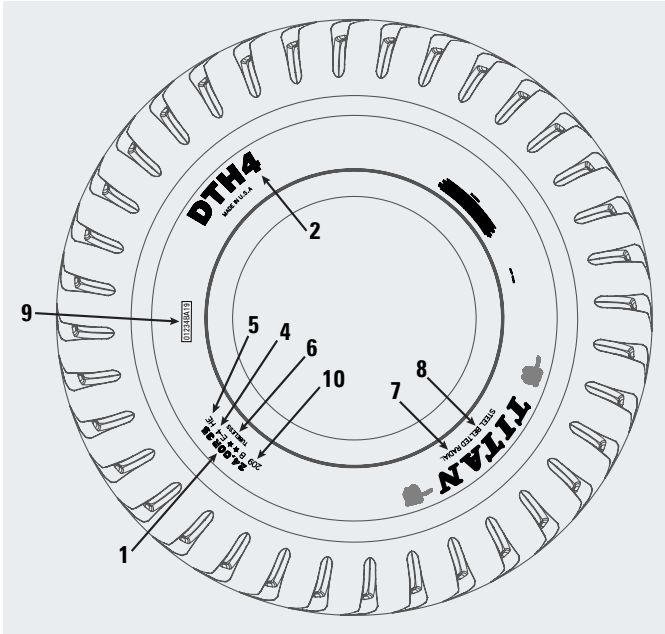

Radial Tires Sidewall Descriptions

1	Tire Size	24.00R35
2	Tread Design	DTH4
3	Load Rating	--
4	Industry Code	E-4
5	Compound	HE
6	Tubeless / Tube Type	Tubeless
7	Construction	Radial
8	Belt Construction	Steel Belted
9	Individual Tire ID	01234BA19
10	Load/Speed Index	209B

Bias Tires

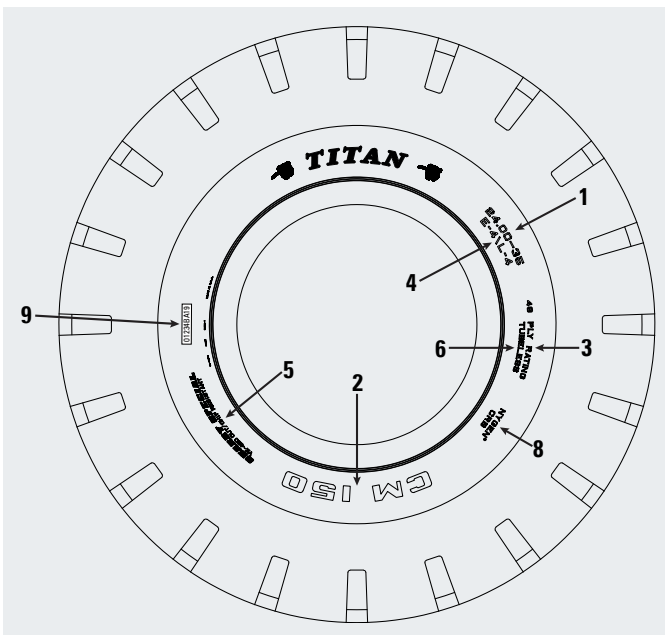











Bias Tires Sidewall Descriptions

1	Tire Size	24.00-35
2	Tread Design	CM 150
3	Load Rating	48 Ply Rating
4	Industry Code	E-4 / L-4
5	Compound	Quarry Special VE-420
6	Tubeless / Tube Type	Tubeless
7	Construction	--
8	Belt Construction	CRB
9	Individual Tire ID	01234BA19

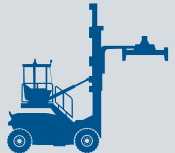
VEHICLE/TRA CODING

Vehicle Classification with International Coding

	VEHICLE TYPE	CODE	INTERNATIONAL CLASSIFICATION	TREAD DEPTH		
OTR TIRES FOR HAULAGE EQUIPMENT						
	Rigid-Frame Dump Truck	E	(Earthmover)			
		E-1	Rib Regular Tread	100%		
		E-2	Traction Regular Tread (Directional)	100%		
		E-3	Regular Tread	100%		
	Articulated Dump Truck	E-2	Traction Regular Tread (Directional)	100%		
		E-3	Regular Tread	100%		
	Scraper	E-3	Regular Tread	100%		
		E-4	Deep Tread	150%		
OTR TIRES FOR OFF-THE-ROAD VEHICLES						
	Wheel Loader	L	(Loader and Dozer)			
		L-2	Traction Regular Tread (Directional)	100%		
		L-3	Regular Tread	100%		
		L-4	Deep Tread	150%		
	Dozer	L-5	Extra Deep Tread	250%		
		L-3S	Smooth Regular Tread	100%		
		L-4S	Smooth Deep Tread	150%		
		L-5S	Smooth Extra Deep Tread	250%		
OTR TIRES FOR GRADERS						
	Grader	G	(Grader)			
		G-1	Rib Regular Tread	100%		
		G-2	Traction Regular Tread (Directional)	100%		
		G-3	Regular Tread	100%		
		G-4	Deep Tread	150%		
		OTR TIRES OF INDUSTRIAL VEHICLES				
			Container Handler	IND	(Industrial Service)	
				IND-4	Deep Tread	150%
IND-4S	Smooth Deep Tread			150%		
IND-5	Extra Deep Tread			250%		
	Slag Pot Carrier	IND-5S	Smooth Extra Deep Tread	250%		
		IND-3	Regular Tread	100%		
	Reach Stacker	IND-4	Deep Tread	150%		
		IND-4S	Smooth Deep Tread	150%		
		IND-5	Extra Deep Tread	250%		
		IND-5S	Smooth Extra Deep Tread	250%		
OTR TIRES FOR COMPACTORS						
	Compactor	C	(Compactor)			
		C-1	Smooth	100%		
OTR TIRES FOR PAVERS						
	Paver	E-7	Flotation	100%		

INDUSTRY STANDARDS & TIRE SELECTION CHART

TRA Code	Tread Type	Tread Depth	Titan Line	
			Radial	Bias
Earthmover Tires				
E-1	Rib Regular	100%	--	--
E-2	Traction Regular	100%	TGD2	--
E-3	Regular	100%	007 MFT, STL2+, STL3, STTR	CM 100, LCM, ND LCM, SL 100, XG-3
E-4	Deep	150%	007 MFT, DTH4	CM 150, HK 458, ND Super LCM, Super LCM
Loader & Dozer Tires				
L-2	Traction Regular	100%	TGD2, TGL2, TGS2	Loader Dozer II, Loader Grader III, Motor Grader HD
L-3	Regular	100%	MXL, STL2+, STL3, STTR	LCM, ND LCM, SL 100, Super Rigger
L-4	Deep	150%	LDR 150	CH 150, CM 150, HK 458, LD 150, LS 150, ND Super LCM, Super LCM
L-5	Extra Deep	250%	LDR 250s	LD 250, LD 250 Haf-Trac
L-4S	Smooth Deep	150%	--	--
L-5S	Smooth Extra Deep	250%	--	LD 250 Haf-Trac, LD 250 Super Smooth
Grader Tires				
G-2	Traction Regular	100%	TG2, TGL2, TGS2	Loader Grader III, Motor Grader HD, HD 2000 II
G-3	Regular	100%	STTR	--
Industrial Tires				
IND-3	Regular	100%	--	CM 100, ND LCM, SL 100
IND-4	Deep	150%	--	CH 150, CM 150, ND Super LCM, SM 150
IND-5	Extra Deep	250%	--	--
IND-4S	Smooth Deep	150%	--	Super Smooth
IND-5S	Smooth Extra Deep	250%	--	--
Compactor Tires				
C-1	Smooth	100%	--	Road Roller II
Paver Tires				
E-7	Flotation	100%	--	Super Sand Flotation



PRESSURE CONVERSIONS

PSI	kPa	bar	PSI	kPa	bar	PSI	kPa	bar	PSI	kPa	bar
1	10	0.1	55	380	3.8	109	750	7.5	5	35	0.35
2	15	0.15	56	385	3.85	110	760	7.6	10	70	0.7
3	20	0.2	57	390	3.9	111	765	7.65	15	100	1
4	25	0.25	58	400	4	112	775	7.75	20	140	1.4
5	35	0.35	59	410	4.1	113	780	7.8	25	170	1.7
6	40	0.4	60	415	4.15	114	785	7.85	30	210	2.1
7	45	0.45	61	420	4.2	115	790	7.9	35	240	2.4
8	55	0.55	62	425	4.25	116	800	8	40	275	2.75
9	60	0.6	63	435	4.35	117	810	8.1	45	310	3.1
10	70	0.7	64	440	4.4	118	815	8.15	50	345	3.45
11	75	0.75	65	450	4.5	119	820	8.2	55	380	3.8
12	80	0.8	66	455	4.55	120	825	8.25	60	415	4.15
13	90	0.9	67	460	4.6	121	835	8.35	65	450	4.5
14	95	0.95	68	470	4.7	122	840	8.4	70	480	4.8
15	100	1	69	475	4.75	123	850	8.5	75	520	5.2
16	110	1.1	70	480	4.8	124	855	8.55	80	550	5.5
17	120	1.2	71	490	4.9	125	860	8.6	85	585	5.85
18	125	1.25	72	495	4.95	126	870	8.7	90	620	6.2
19	130	1.3	73	500	5	127	875	8.75	95	655	6.55
20	140	1.4	74	510	5.1	128	880	8.8	100	690	6.9
21	145	1.45	75	520	5.2	129	890	8.9	105	725	7.25
22	150	1.5	76	525	5.25	130	900	9	110	760	7.6
23	160	1.6	77	530	5.3	131	905	9.05	115	790	7.9
24	165	1.65	78	540	5.4	132	910	9.1	120	825	8.25
25	170	1.7	79	545	5.45	133	920	9.2	125	860	8.6
26	180	1.8	80	550	5.5	134	925	9.25	130	900	9
27	185	1.85	81	560	5.6	135	930	9.3	135	930	9.3
28	190	1.9	82	565	5.65	136	940	9.4	140	965	9.65
29	200	2	83	575	5.75	137	945	9.45	145	1,000	10
30	210	2.1	84	580	5.8	138	950	9.5			
31	215	2.15	85	585	5.85	139	960	9.6			
32	220	2.2	86	590	5.9	140	965	9.65			
33	230	2.3	87	600	6	141	975	9.75			
34	235	2.35	88	610	6.1	142	980	9.8			
35	240	2.4	89	615	6.15	143	985	9.85			
36	250	2.5	90	620	6.2	144	990	9.9			
37	255	2.55	91	625	6.25	145	1,000	10			
38	260	2.6	92	635	6.35						
39	270	2.7	93	640	6.4						
40	275	2.75	94	650	6.5						
41	280	2.8	95	655	6.55						
42	290	2.9	96	660	6.6						
43	295	2.95	97	670	6.7						
44	300	3	98	675	6.75						
45	310	3.1	99	680	6.8						
46	320	3.2	100	690	6.9						
47	325	3.25	101	695	6.95						
48	330	3.3	102	700	7						
49	340	3.4	103	710	7.1						
50	345	3.45	104	720	7.2						
51	350	3.5	105	725	7.25						
52	360	3.6	106	730	7.3						
53	365	3.65	107	740	7.4						
54	375	3.75	108	745	7.45						

LOAD INDEX/SPEED SYMBOL

Index	kg	lbs	Index	kg	lbs	Index	kg	lbs	Index	kg	lbs
0	45	99	42	150	330	84	500	1100	126	1,700	3,740
1	46.2	102	43	155	340	85	515	1140	127	1,750	3,860
2	47.5	105	44	160	355	86	530	1170	128	1,800	3,960
3	48.7	107	45	165	365	87	545	1200	129	1,850	4,080
4	50	110	46	170	375	88	560	1230	130	1,900	4,180
5	51.5	114	47	175	385	89	580	1280	131	1,950	4,300
6	53	117	48	180	395	90	600	1320	132	2,000	4,400
7	54.5	120	49	185	410	91	615	1360	133	2,060	4,540
8	56	123	50	190	420	92	630	1390	134	2,120	4,680
9	58	128	51	195	430	93	650	1430	135	2,180	4,800
10	60	132	52	200	440	94	670	1480	136	2,240	4,940
11	61.5	136	53	206	455	95	690	1520	137	2,300	5,080
12	63	139	54	212	465	96	710	1570	138	2,360	5,200
13	65	143	55	218	480	97	730	1610	139	2,430	5,360
14	67	148	56	224	495	98	750	1650	140	2,500	5,520
15	69	152	57	230	505	99	775	1710	141	2,575	5,680
16	71	157	58	236	520	100	800	1760	142	2,650	5,840
17	73	161	59	243	535	101	825	1820	143	2,725	6,000
18	75	165	60	250	550	102	850	1870	144	2,800	6,150
19	77.5	170	61	257	565	103	875	1930	145	2,900	6,400
20	80	175	62	265	585	104	900	1980	146	3,000	6,600
21	82.5	180	63	272	600	105	925	2040	147	3,075	6,800
22	85	185	64	280	615	106	950	2090	148	3,150	6,950
23	87.5	195	65	290	640	107	975	2150	149	3,250	7,150
24	90	200	66	300	660	108	1000	2200	150	3,350	7,400
25	92.5	205	67	307	675	109	1030	2270	151	3,450	7,600
26	95	210	68	315	695	110	1060	2340	152	3,550	7,850
27	97.5	215	69	325	715	111	1090	2400	153	3,650	8,050
28	100	220	70	335	740	112	1120	2470	154	3,750	8,250
29	103	225	71	345	760	113	1150	2540	155	3,875	8,550
30	106	235	72	355	785	114	1180	2600	156	4,000	8,800
31	109	240	73	365	805	115	1215	2680	157	4,125	9,100
32	112	245	74	375	825	116	1250	2760	158	4,250	9,350
33	115	255	75	387	855	117	1285	2830	159	4,375	9,650
34	118	260	76	400	880	118	1320	2910	160	4,500	9,900
35	121	265	77	412	910	119	1360	3000	161	4,625	10,200
36	125	275	78	425	935	120	1400	3080	162	4,750	10,500
37	128	280	79	437	965	121	1450	3200	163	4,875	10,700
38	132	290	80	450	990	122	1,500	3,300	164	5,000	11,000
39	136	300	81	462	1020	123	1,550	3,420	165	5,150	11,400
40	140	310	82	475	1050	124	1,600	3,520	166	5,300	11,700
41	145	320	83	487	1070	125	1,650	3,640	167	5,450	12,000

Index	kg	lbs
168	5,600	12,300
169	5,800	12,800
170	6,000	13,200
171	6,150	13,600
172	6,300	13,900
173	6,500	14,300
174	6,700	14,800
175	6,900	15,200
176	7,100	15,700
177	7,300	16,100
178	7,500	16,500
179	7,750	17,100
180	8,000	17,600
181	8,250	18,200
182	8,500	18,700
183	8,750	19,300
184	9,000	19,800
185	9,250	20,400
186	9,500	20,900
187	9,750	21,500
188	10,000	22,000
189	10,300	22,700
190	10,600	23,400
191	10,900	24,000
192	11,200	24,700
193	11,500	25,400
194	11,800	26,000
195	12,150	26,800
196	12,500	27,600
197	12,850	28,300
198	13,200	29,100
199	13,600	30,000
200	14,000	30,900
201	14,500	32,000
202	15,000	33,100
203	15,500	34,200
204	16,000	35,300
205	16,500	36,400
206	17,000	37,500
207	17,500	38,600
208	18,000	39,700
209	18,500	40,800
210	19,000	41,900
211	19,500	43,000
212	20,000	44,100
213	20,600	45,400

Index	kg	lbs
214	21,200	46,700
215	21,800	48,100
216	22,400	49,400
217	23,000	50,700
218	23,600	52,000
219	24,300	53,600
220	25,000	55,100
221	25,750	56,800
222	26,500	58,400
223	27,250	60,000
224	28,000	61,500
225	29,000	64,000
226	30,000	66,000
227	30,750	68,000
228	31,500	69,500
229	32,500	71,500
230	33,500	74,000
231	34,500	76,000
232	35,500	78,500
233	36,500	80,500
234	37,500	82,500
235	38,750	85,500
236	40,000	88,000
237	41,250	91,000
238	42,500	93,500
239	43,750	96,500
240	45,000	99,000
241	46,250	102,000
242	47,500	104,500
243	48,750	107,500
244	50,000	110,000
245	51,500	113,500
246	53,000	117,000
247	54,500	120,000
248	56,000	123,500
249	58,000	128,000
250	60,000	132,500
251	61,500	135,500
252	63,000	139,000
253	65,000	143,500
254	67,000	147,500
255	69,000	152,000
256	71,000	156,500
257	73,000	161,000
258	75,000	165,500
259	77,500	171,000

Index	kg	lbs
260	80,000	176,500
261	82,500	182,000
262	85,000	187,500
263	87,500	193,000
264	90,000	198,500
265	92,500	204,000
266	95,000	209,500
267	97,500	215,000
268	100,000	220,500
269	103,000	227,000
270	106,000	233,500
271	109,000	240,500
272	112,000	247,000
273	115,000	253,500
274	118,000	260,000
275	121,000	267,000
276	125,000	275,500
277	128,500	283,500
278	132,000	291,000
279	136,000	300,000
280	140,000	308,500
281	145,000	319,500
282	150,000	330,500
283	155,000	341,500
284	160,000	352,500
285	165,000	364,000
286	170,000	375,000
287	175,000	386,000
288	180,000	397,000
289	185,000	408,000
290	190,000	419,000
291	195,000	430,000
292	200,000	441,000
293	206,000	454,000
294	212,000	467,500
295	218,000	480,500
296	224,000	494,000
297	230,000	507,000
298	236,000	520,500
299	243,000	535,500
300	250,000	551,000
301	257,500	567,500
302	265,000	584,000
303	272,500	600,500

Speed Symbol		
Symbol	km/h	mph
A1	5	2.5
A2	10	5
A3	15	10
A4	20	12.5
A5	25	15
A6	30	20
A7	35	22.5
A8	40	25
B	50	30
C	60	35
D	65	40
E	70	43
F	80	50
G	90	55
J	100	62
K	110	68
L	120	75
M	130	81
N	140	87
P	150	93
Q	160	99
R	170	106
S	180	112
T	190	118
U	200	124
H	210	130
V	240	149
W	270	168
Y	300	186

TIRE INFLATION GUIDE

Under Inflation

- Insufficient air pressure
- Poor traction, rapid shoulder wear and decreased casing durability

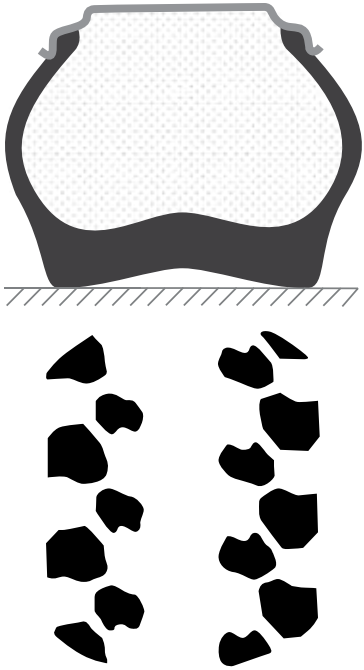

Proper Inflation

- Correct air pressure
- Good traction and wear

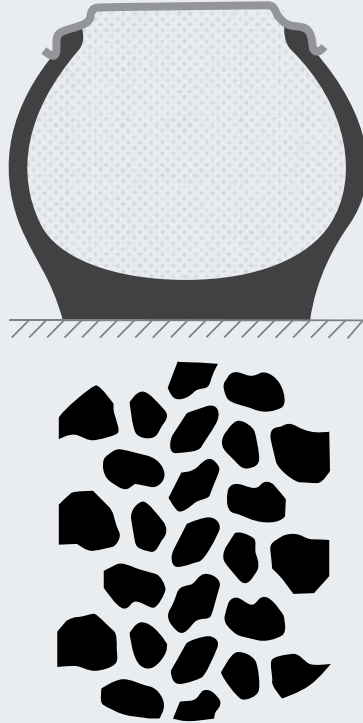

Over Inflation

- Excessive air pressure
- Poor traction and rapid wear

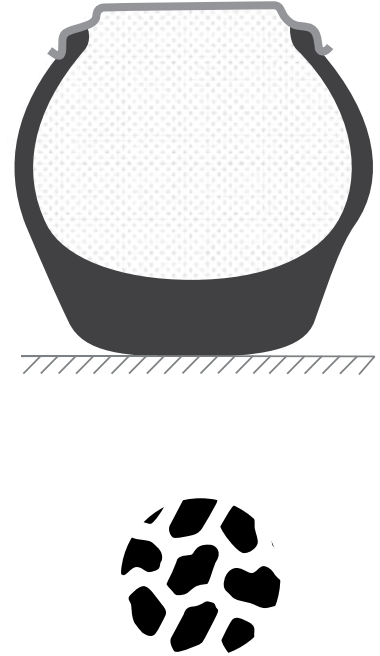

*See page 157 in the Tire Maintenance section for more information.



OTR PRODUCT APPLICATION GUIDES



Radial OTR Tire Applications: Earthmover Equipment



Notes:

Radial OTR Tire Applications: Grading Equipment

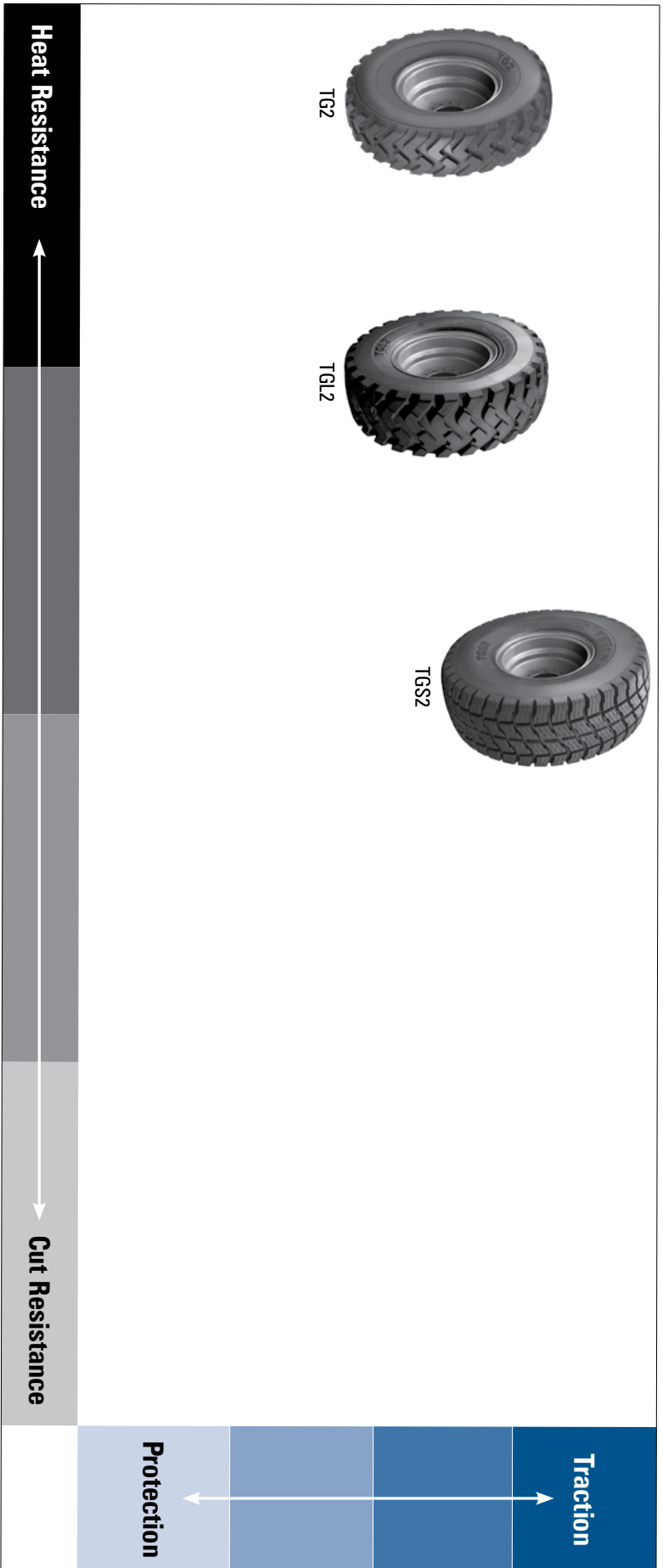

Notes:



Radial OTR Tire Applications: Loader/Dozer Equipment

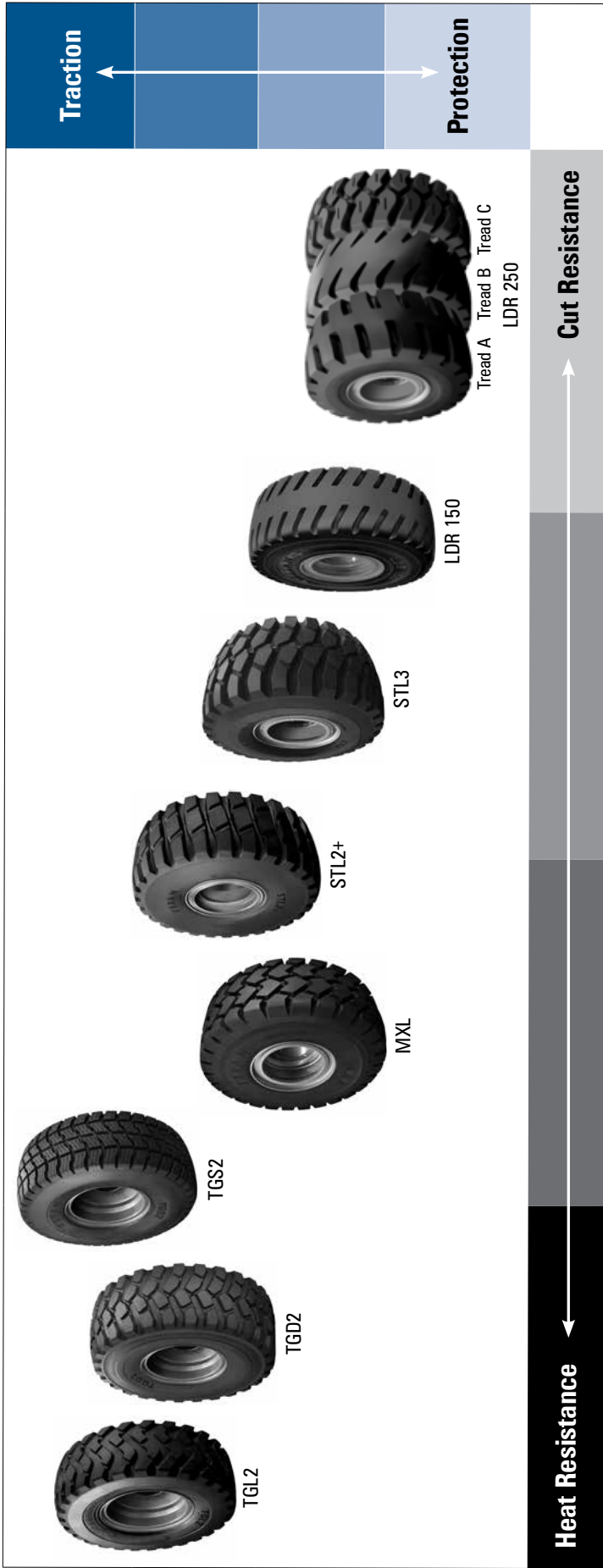

Notes:

Bias OTR Tire Applications: Earthmover Equipment

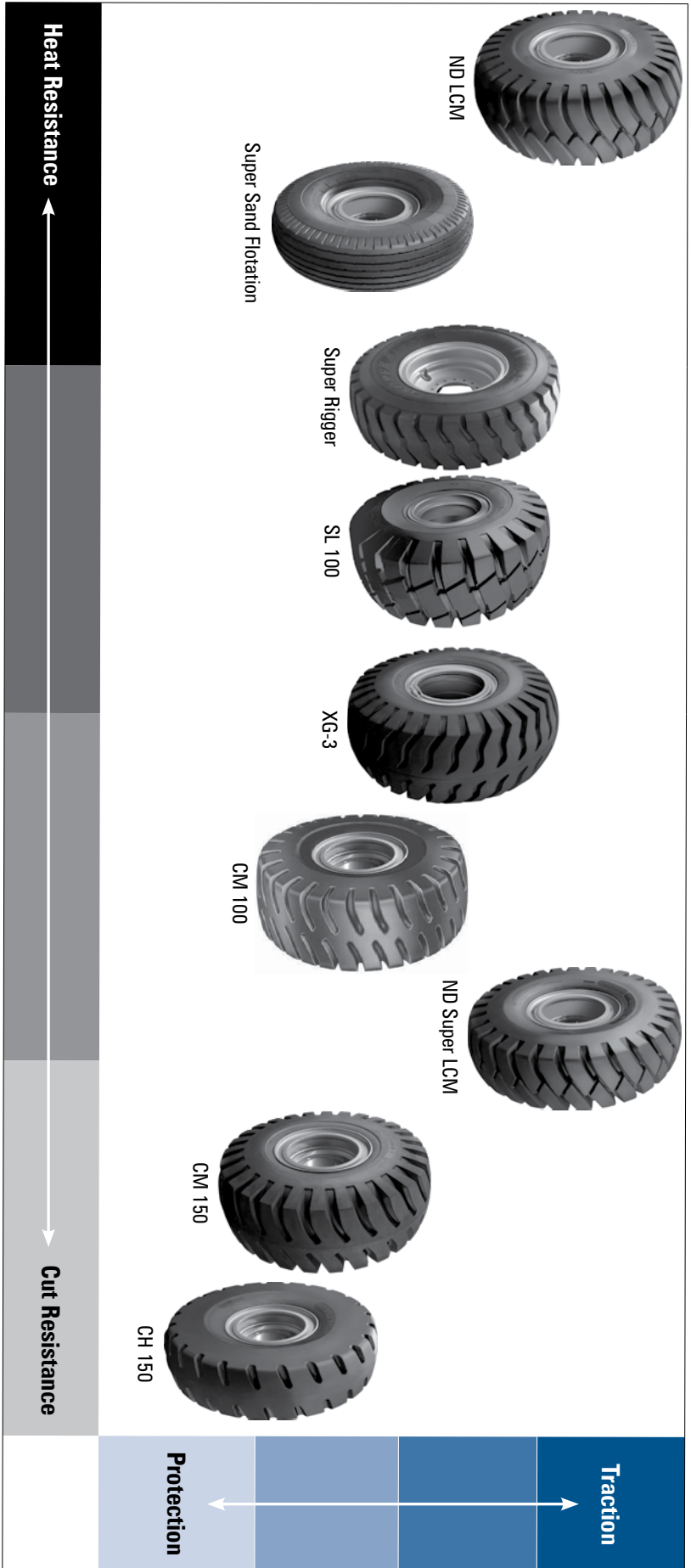

Notes:

Bias OTR Tire Applications: Grading Equipment



Loader Grader III



Motor Grader HD

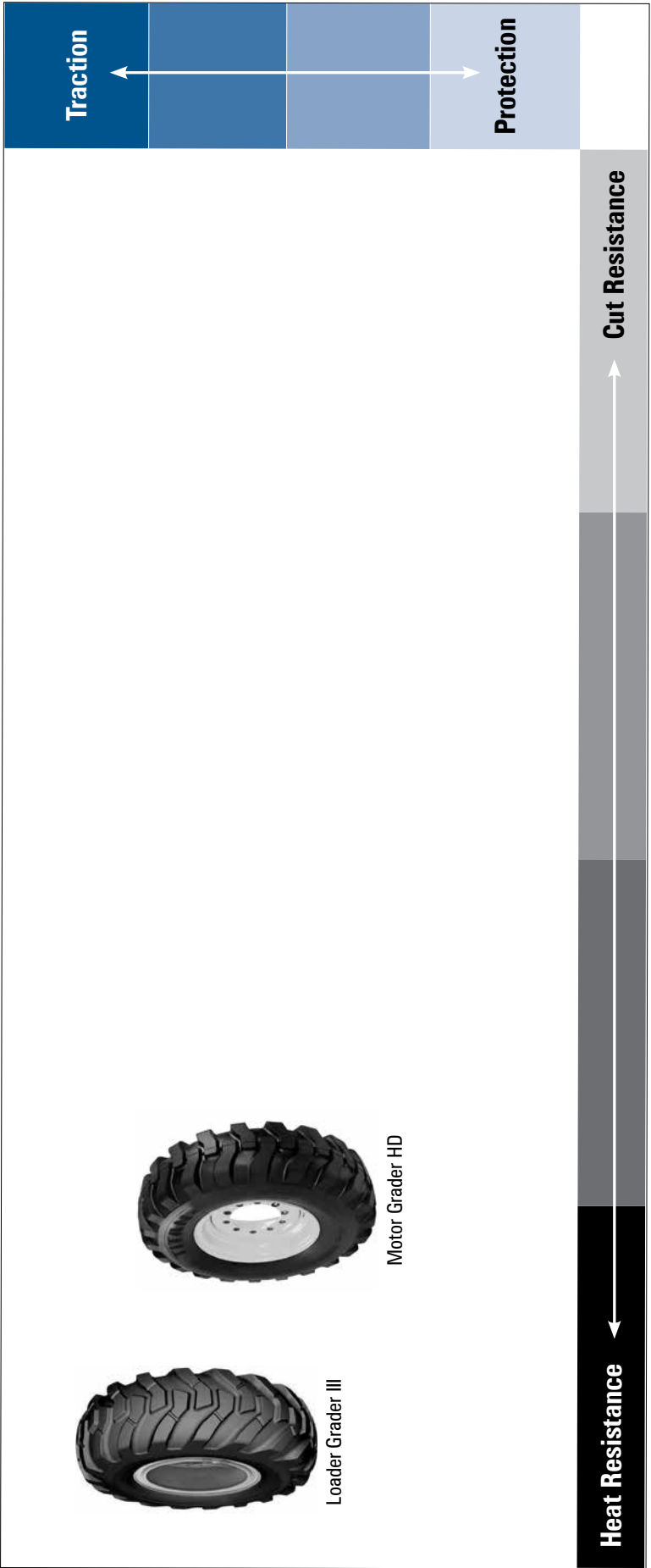

Notes:

Bias OTR Tire Applications: Loader/Dozer Equipment

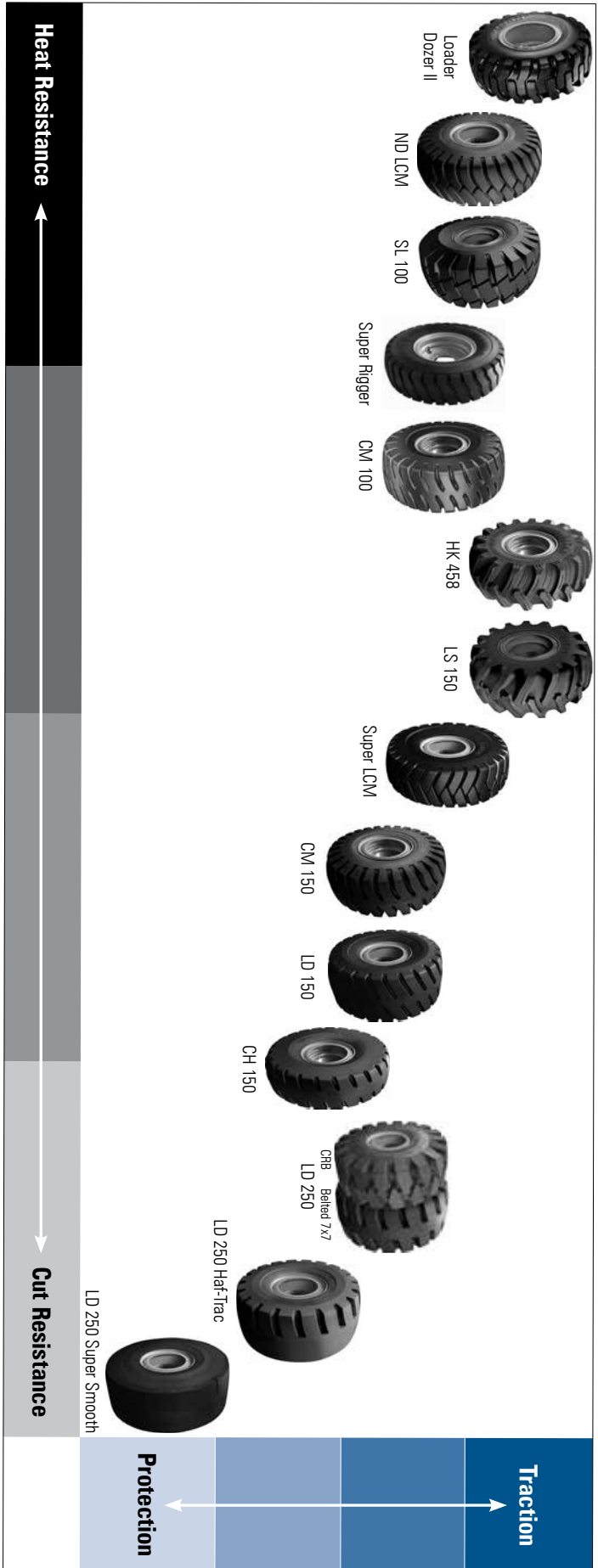

Notes:

Bias OTR Tire Applications: Industrial Equipment

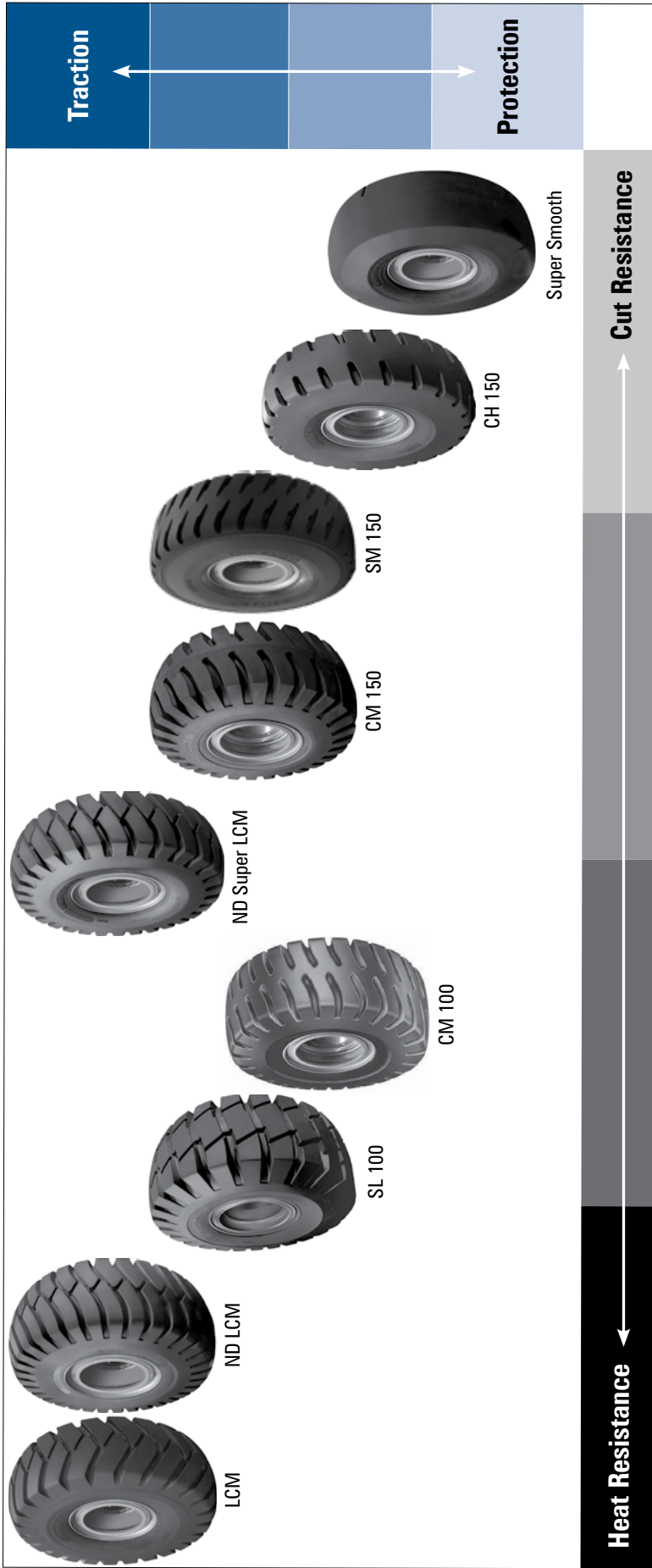

Notes:



TITAN OTR TIRES





TITAN OTR TIRES TABLE OF CONTENTS

Index by Size	22	Bias Industrial	
Tread Patterns	24	Titan LCM (L-3).....	49
Radial OTR		Titan CM 100 (E-3/L-3)*.....	49
Titan TGD2 (E-2/L-2).....	27	Titan ND LCM (E-3/L-3), (IND-3), or (L-3)*.....	50
Titan TG2 (G-2).....	27	Titan CH 150 (E-4/L-4).....	50
Titan TGS2 (G-2) or (G-2/L-2).....	27	Titan SM 150 (IND-4)*.....	51
Titan TGL2 (G-2/L-2).....	28	Titan CM 150 (E-4/L-4) or (IND-4)*.....	52
Titan MXL (L-3).....	29	Titan Quarry Special (E-4/L-4)*.....	52
Titan STL2+ (E-3T/L-3T).....	30	Titan ND Super LCM (E-4/L-4).....	53
Titan STTR (E-3/L-3) or (G-3/L-3).....	30	Titan Super Smooth (L-4S).....	53
Titan STL3 (E-3/L-3).....	31	Bias UGM	
Titan DTH4 (E-4).....	32	Titan LD 250 Super Smooth UGM (L-5S)*.....	54
Titan 007 MFT (E-4) or (E-4+).....	32	Bias Forestry	
Titan LDR 150 (L-4).....	32	Goodyear Logger Lug III HD (LS-2).....	55
Titan LDR 250 (L-5).....	33	Goodyear Logger Lug III (LS-2).....	56
Bias Earthmoving		Goodyear Logger Lug III Flotation (HF-3+) or (HF-4).....	56
Titan CM 100 (E-3) or (E-3/L-3)*.....	34	Bias Compactor	
Titan ND LCM (E-3) or (E-3/L-3)*.....	34	Titan Road Roller II (C-1).....	57
Titan SL 100 (E-3) or (E-3/L-3)*.....	35	Backhoe	
Titan Super Rigger (E-3/L-3).....	35	Titan Industrial Tractor Lug (R-4).....	58
Titan XG-3 (E-3)*.....	36	Goodyear IT520 (R-4).....	58
Titan CH 150 (E-4/L-4)*.....	36	Goodyear IT525 (R-4).....	59
Titan CM 150 (E-4) or (E-4/L-4).....	36	Goodyear IT530 (R-4).....	60
Titan Quarry Special (E-4) or (E-4/L-4)*.....	37	Titan Contractor (F-3).....	60
Titan HK 458 (E-4/L-4).....	38	Goodyear Laborer (F-3).....	61
Titan ND Super LCM (E-4) or (E-4/L-4).....	38	Titan Contractor II (I-3).....	61
Titan Super Sand Flotation (E-7).....	38	Titan Contractor-T (I-3).....	61
Bias Grader		Goodyear Sure Grip Lug (I-3).....	62
Titan Motor Grader HD (G-2).....	39	Titan TI422 (I-3).....	62
Titan Loader Grader III (G-2).....	39	Skid Steer	
Bias Loader-Dozer		Titan Contractor FWD (SS).....	63
Titan Loader Dozer II (L-2).....	40	Titan HD 2000 (SS).....	63
Titan CM 100 (E-3/L-3)*.....	40	Titan HD 2000 II (SS).....	63
Titan SL 100 (E-3/L-3)*.....	41	Titan H/E (SS).....	64
Titan ND LCM (E-3/L-3) or (L-3)*.....	41	Titan LSW G9A (SS).....	64
Titan Super Rigger (E-3/L-3).....	42	Titan TGS2 (SS).....	64
Titan CH 150 (E-4/L-4).....	42	Titan Trac Loader Chevron (SS).....	65
Titan CM 150 (E-4/L-4)*.....	42	Titan Ultimate (SS).....	65
Titan Quarry Special (E-4/L-4)*.....	43		
Titan Super LCM (L-4).....	43		
Titan HK 458 (E-4/L-4).....	44		
Titan HK 458 Tire Development.....	45		
Titan LD 150 (L-4)*.....	46		
Titan LS 150 (L-4T).....	47		
Titan LD 250 (L-5)*.....	47		
Titan LD 250 Haf-Trac (L-5/L-5S).....	47		
Titan LD 250 Super Smooth (L-5S)*.....	48		

*Aralon® is not a registered trademark of Titan International, Inc.

TITAN OTR TIRES INDEX BY SIZE

RADIAL			
Rim Diam.	Tire Size	Tread Pattern	Pg.
24"	14.00R24TG	TG2 (G-2)	27
24"	14.00R24TG	TGS2 (G-2)	27
24"	460/70R24IND	IT520* (R-4)	58
24"	500/70R24	IT530* (R-4)	60
25"	17.5R25	STTR (G-3/L-3)	30
25"	17.5R25	TGL2 (G-2/L-2)	28
25"	17.5R25	TGS2 (G-2/L-2)	27
25"	17.5R25	MXL (L-3)	29
25"	20.5R25	STL3 (E-3/L-3)	31
25"	20.5R25	STTR (E-3/L-3)	30
25"	20.5R25	TGD2 (E-2/L-2)	27
25"	20.5R25	MXL (L-3)	29
25"	23.5R25	STL3 (E-3/L-3)	31
25"	23.5R25	STTR (E-3/L-3)	30
25"	23.5R25	MXL (L-3)	29
25"	26.5R25	STL2+ (E-3T/L-3T)	30
25"	26.5R25	STL3 (E-3/L-3)	31
25"	29.5R25	STL2+ (E-3T/L-3T)	30
25"	29.5R25	STL3 (E-3/L-3)	31
25"	750/65R25	STL3 (E-3/L-3)	31
29"	29.5R29	LDR 250 (L-5)	33
29"	875/65R29	STL3 (E-3/L-3)	31
33"	35/65R33	LDR 250 (L-5)	33
35"	24.00R35	DTH4 (E-4)	32
45"	45/65R45	LDR 250 (L-5)	33
49"	27.00R49	007 MFT (E-4)	32
51"	33.00R51	007 MFT (E-4)	32
51"	50/65R51	LDR 250 (L-5)	33
57"	37.00R57	007 MFT (E-4+)	32
57"	40.00R57	007 MFT (E-4)	32
57"	46/90R57	007 MFT (E-4)	32
57"	50/80R57	007 MFT (E-4)	32
63"	58/80R63	LDR 150 (L-4)	32

BIAS			
Rim Diam.	Tire Size	Tread Pattern	Pg.
17"	480/45-17	Contractor (F-3)	60
17.5"	14-17.5NHS	H/E (SS)	64
17.5"	14-17.5NHS	HD 2000 II (SS)	63
17.5"	14-17.5NHS	Ultimate (SS)	65
18"	10.5/80-18	Contractor-T (I-3)	61
18"	12.5/80-18	Contractor II (I-3)	61
18"	12.5/80-18	Contractor-T (I-3)	61
18"	12.5/80-18	Sure Grip Lug* (I-3)	62
18"	12.5/80-18NHS	TI422 (I-3)	62
19.5"	15-19.5NHS	HD 2000 (SS)	63
24"	12.00-24NHS	LD 250 Super Smooth UGM (L-5S)	54
24"	13.00-24TG	Loader Grader III (G-2)	39
24"	13.00-24TG	Motor Grader HD (G-2)	39
24"	13.00-24TG	Super Rigger (E-3/L-3)	35, 42
24"	14.00-24TG	Motor Grader HD (G-2)	39
24"	14.00-24TG	Super Rigger (E-3/L-3)	35, 42
24"	14.00-24TG	Loader Grader III (G-2)	39
24"	14.9-24	Industrial Tractor Lug (R-4)	58
24"	16.00-24DT	Super Sand Flotation (E-7)	38
24"	16.9-24	Industrial Tractor Lug (R-4)	58
24"	16.9-24	IT525* (R-4)	59
24"	17.5L-24	Industrial Tractor Lug (R-4)	58
24"	18.4-24	Industrial Tractor Lug (R-4)	58
24"	18.4-24	IT525* (R-4)	59
24"	19.5L-24	Industrial Tractor Lug (R-4)	58
24"	19.5L-24	IT525* (R-4)	59
24"	21L-24	Industrial Tractor Lug (R-4)	58
24"	21L-24	IT525* (R-4)	59
24"	420/70-24	Industrial Tractor Lug (R-4)	58
25"	14.00-25NHS	Super Rigger (E-3/L-3)	35, 42
25"	15.5-25	Loader Dozer II (L-2)	40
25"	16.00-25	ND LCM (L-3)	41, 50
25"	16.00-25	Super LCM (L-4)	43
25"	17.5-25	Loader Dozer II (L-2)	40
25"	18.00-25	ND LCM (E-3)	34
25"	18.00-25	ND Super LCM (E-4)	38
25"	18.00-25	CH 150 (E-4/L-4)	36, 42, 50
25"	18.00-25	ND Super LCM (E-4/L-4)	38, 53
25"	18.00-25	LD 250 Super Smooth UGM (L-5S)	54
25"	18.00-25	Super Smooth L-4S (L-4S)	53
25"	20.5-25	HK 458 (E-4/L-4)	38, 44
25"	20.5-25	ND LCM (E-3/L-3)	34, 41, 50
25"	20.5-25	LD 250 (L-5)	47
25"	20.5-25	Loader Dozer II (L-2)	40
25"	21.00-25	LCM (L-3)	49
25"	23.5-25	HK 458 (E-4/L-4)	38, 44
25"	23.5-25	ND LCM (E-3/L-3)	34, 41, 50
25"	23.5-25	LD 250 (L-5)	47
25"	23.5-25	Loader Dozer II (L-2)	40
25"	23.5-25	LD 150 (L-4)	46
25"	23.5-25	LD 250 Super Smooth (L-5S)	48
25"	26.5-25	ND LCM (E-3/L-3)	34, 41, 50
25"	26.5-25	LD 250 (L-5)	47
25"	26.5-25	LD 250 Super Smooth UGM (L-5S)	54
25"	26.5-25	LD 250 Super Smooth (L-5S)	48
25"	29.5-25	ND LCM (E-3/L-3)	34, 41, 50
25"	29.5-25	LD 150 (L-4)	46

BIAS			
Rim Diam.	Tire Size	Tread Pattern	Pg.
546 mm	LSW305-546NHS	LSW G9A (SS)	64
15"	11L-15SL	Laborer* (F-3)	61
15"	7.00-15SS	Trac Loader Chevron (SS)	65
15"	7.50-15NHS	Road Roller II (C-1)	57
15"	8.5/90-15K	Road Roller II (C-1)	57
16"	11L-16SL	Contractor (F-3)	60
16"	11L-16SL	Laborer* (F-3)	61
16.1"	14.5/75-16.1SL	Contractor (F-3)	60
16.5"	10-16.5NHS	HD 2000 (SS)	63
16.5"	10-16.5NHS	HD 2000 II (SS)	63
16.5"	10-16.5NHS	Ultimate (SS)	65
16.5"	10-16.5NHS	H/E (SS)	64
16.5"	12-16.5NHS	Contractor FWD (SS)	63
16.5"	12-16.5NHS	HD 2000 II (SS)	63
16.5"	12-16.5NHS	TGS2 (SS)	64
16.5"	12-16.5NHS	Ultimate (SS)	65
16.5"	12-16.5NHS	H/E (SS)	64
16.5"	31x15.50-16.5	HD 2000 II (SS)	63
16.5"	33x15.50-16.5	HD 2000 II (SS)	63

*Goodyear Farm Tires Product Line

BIAS				BIAS			
Rim Diam.	Tire Size	Tread Pattern	Pg.	Rim Diam.	Tire Size	Tread Pattern	Pg.
25"	29.5-25	LD 250 (L-5)	47	33"	35/65-33	LD 250 Haf-Trac (L-5/L-5S)	47
25"	29.5-25	LD 250 Super Smooth UGM (L-5S)	54	33"	35/65-33	LD 250 Super Smooth (L-5S)	48
25"	29.5-25	LD 250 Super Smooth (L-5S)	48	33"	35/65-33	LD 250 Super Smooth UGM (L-5S)	54
25"	66X43.00-25NHS	Logger Lug III Flotation* (HF-4)	56	33"	37.5-33	ND LCM (E-3/L-3)	35, 41, 50
25"	67X34.00-25NHS	Logger Lug III Flotation* (HF-4)	56	35"	21.00-35	Quarry Special (E-4/L-4)	37, 43, 52
25"	725/70-25	LS 150 (L-4T)	47	35"	24.00-35	Quarry Special (E-4/L-4)	37, 43, 52
26"	18.4-26	Industrial Tractor Lug (R-4)	58	35"	29.5-35	ND LCM (E-3)	34
26"	23.1-26	Logger Lug III* (LS-2)	56	35"	33.25-35	CM 150 (E-4)	36
26"	28L-26	Logger Lug III HD* (LS-2)	55	35"	33.25-35	CM 150 (E-4/L-4)	36, 42, 52
26"	66X43.00-26NHS	Logger Lug III Flotation* (HF-4)	56	35"	33.25-35	ND LCM (E-3/L-3)	35, 41, 50
26"	67X34.00-26NHS	Logger Lug III Flotation* (HF-4)	56	35"	37.25-35	CM 150 (E-4)	36
28"	16.9-28	IT525* (R-4)	59	35"	37.25-35	SL 100 (E-3)	35
28"	18.4-28	Industrial Tractor Lug (R-4)	58	35"	37.25-35	XG-3 (E-3)	36
28"	21L-28	IT525* (R-4)	59	35"	37.25-35	CM 150 (IND-4)	52
29"	29.5-29	ND LCM (E-3/L-3)	34, 41, 50	39"	37.5-39	CM 100 (E-3)	34
29"	29.5-29	LD 250 Super Smooth UGM (L-5S)	54	39"	37.5-39	CM 100 (E-3/L-3)	34, 40, 49
29"	33.25-29	SL 100 (E-3/L-3)	35, 41	39"	40/65-39	LD 250 (L-5)	47
32"	24.5-32	Logger Lug III* (LS-2)	56	39"	41.25/70-39	LD 250 (L-5)	47
32"	30.5L-32	Logger Lug III HD* (LS-2)	55	39"	41.25/70-39	LD 250 Super Smooth (L-5S)	48
32"	DH35.5L-32	Logger Lug III HD* (LS-2)	55	45"	45/65-45	LD 250 (L-5)	47
32"	DH73X44.00-32	Logger Lug III Flotation* (HF-3+)	56	45"	45/65-45	LD 250 Super Smooth (L-5S)	48
32"	DH73X50.00-32	Logger Lug III Flotation* (HF-3+)	56	49"	24.00-49	Quarry Special (E-4/L-4)	37, 43, 52
33"	18.00-33	Quarry Special (E-4)	37	49"	27.00-49	Quarry Special (E-4/L-4)	37, 43, 52
33"	18.00-33	CM 150 (E-4/L-4)	36, 52	51"	30.00-51	Quarry Special (E-4/L-4)	37, 43, 52
33"	18.00-33	Super Smooth L-4S (L-4S)	53	51"	33.00-51	Quarry Special (E-4/L-4)	43, 52
33"	33.5-33	ND LCM (E-3)	35	51"	33.00-51	Quarry Special (E-4)	37
33"	33.5-33	ND LCM (IND-3)	50	51"	36.00-51	Quarry Special (E-4/L-4)	37, 43, 52
33"	35/65-33	LD 150 (L-4)	46	57"	40.00-57	SM 150 (IND-4)	51
33"	35/65-33	LD 250 (L-5)	47				

*Goodyear Farm Tires Product Line



TITAN OTR TIRES TREAD PATTERNS

■ RADIAL OTR
 ■ BIAS EARTHMOVING
 ■ BIAS GRADER
 ■ BIAS LOADER-DOZER



TGD2 (E-2/L-2)
P. 27



TG2 (G-2)
P. 27



TGS2 (G-2) or (G-2/L-2)
P. 27



TGL2 (G-2/L-2)
P. 28



MXL (L-3)
P. 29



STL2+ (E-3T/L-3T)
P. 30



**STTR (E-3/L-3)
or (G-3/L-3)** P. 30



STL3 (E-3/L-3)
P. 31



DTH4 (E-4)
P. 32



007 MFT (E-4) or (E-4+)
P. 32



LDR 150 (L-4)
P. 32



LDR 250 (L-5)
P. 33



CM 100 (E-3) or (E-3/L-3)
P. 34



ND LCM (E-3) or (E-3/L-3)
P. 34



SL 100 (E-3) or (E-3/L-3)
P. 35



SUPER RIGGER (E-3/L-3)
P. 35



XG-3 (E-3)
P. 36



CH 150 (E-4/L-4)
P. 36



CM 150 (E-4) or (E-4/L-4)
P. 36



**QUARRY SPECIAL
(E-4) or (E-4/L-4)** P. 37



HK 458 (E-4/L-4)
P. 38



**ND SUPER LCM
(E-4) or (E-4/L-4)** P. 38



**SUPER SAND FLOTATION
(E-7)** P. 38



MOTOR GRADER HD (G-2)
P. 39



LOADER GRADER III (G-2)
P. 39



LOADER DOZER II (L-2)
P. 40



CM 100 (E-3/L-3)
P. 40



SL 100 (E-3/L-3)
P. 41



ND LCM (E-3/L-3) or (L-3)
P. 41



SUPER RIGGER (E-3/L-3)
P. 42

 CH 150 (E-4/L-4) P. 42	 CM 150 (E-4/L-4) P. 42	 QUARRY SPECIAL (E-4/L-4) P. 43	 SUPER LCM (L-4) P. 43	 HK 458 (E-4/L-4) P. 44
 LD 150 (L-4) P. 46	 LS 150 (L-4T) P. 47	 LD 250 (L-5) P. 47	 LD 250 HAF-TRAC (L-5/L-5S) P. 47	 LD 250 SUPER SMOOTH (L-5S) P. 48
 LCM (L-3) P. 49	 CM 100 (E-3/L-3) P. 49	 ND LCM (E-3/L-3), (IND-3), or (L-3) P. 50	 CH 150 (E-4/L-4) P. 50	 SM 150 (IND-4) P. 51
 CM 150 (E-4/L-4) or (IND-4) P. 52	 QUARRY SPECIAL (E-4/L-4) P. 52	 ND SUPER LCM (E-4/L-4) P. 53	 SUPER SMOOTH (L-4S) P. 53	 LD 250 SUPER SMOOTH UGM (L-5S) P. 54
 LOGGER LUG III HD* (LS-2) P. 55	 LOGGER LUG III* (LS-2) P. 56	 LOGGER LUG III FLOTATION* (HF-3+) or (HF-4) P. 56	 ROAD ROLLER II (C-1) P. 57	 INDUSTRIAL TRACTOR LUG (R-4) P. 58
 IT520* (R-4) P. 58	 IT525* (R-4) P. 59	 IT530* (R-4) P. 60	 CONTRACTOR (F-3) P. 60	 LABORER* (F-3) P. 61

■ BIAS LOADER-DOZER
■ BIAS INDUSTRIAL
■ BIAS UGM/MATERIAL HANDLING
■ BIAS FORESTRY
■ BIAS COMPACTOR
■ BACKHOE

*Goodyear Farm Tires Product Line
 Note: Titan tires face left; Goodyear Farm Tires face right

Continues on Next Page



CONTRACTOR II (I-3)
P. 61



CONTRACTOR-T (I-3)
P. 61



SURE GRIP LUG* (I-3)
P. 62



TI422 (I-3)
P. 62



CONTRACTOR FWD (SS)
P. 63



HD 2000 (SS)
P. 63



HD 2000 II (SS)
P. 63



H/E (SS)
P. 64



LSW G9A (SS)
P. 64



TGS2 (SS)
P. 64



**TRAC LOADER
CHEVRON (SS) P. 65**



ULTIMATE (SS)
P. 65

*Goodyear Farm Tires Product Line

Note: Titan tires face left; Goodyear Farm Tires face right





TITAN TGD2 (E-2/L-2)

- Directional tread design for excellent forward traction
- Center riding rib for smooth ride and even wear
- Steel belted construction to provide increased cut resistance and extended wear



Tire Size	Compound/ Construction	Catalog #	Industry Code	Load/ Speed Index	Load Rating	Recom'd Rim Code	Outside Diameter (in)	Overall Width (in)	Static Loaded Width (in)	Static Loaded Radius (in)	Flat Plate Area (in ²)	Tread Depth (32 nd in)	Rated Load @ Inflation (lbs @ psi)	Weight (lbs)
20.5R25	CE	EDTB21	E-2	177B	2*	17.00 / 2.0	58.3	20.5	22.0	26.3	271	36	16,100 @ 76	566
			L-2	186A2	1*		58.3	20.5	22.5	25.6	333		20,900 @ 73	



TITAN TG2 (G-2)

- Exceptional traction design
- Non-directional tread pattern provides long tread life
- Open tread pattern provides excellent self-cleaning
- Steel belted construction to provide increased cut resistance and extended wear



Tire Size	Compound/ Construction	Catalog #	Industry Code	Load/ Speed Index	Load Rating	Recom'd Rim Code	Outside Diameter (in)	Overall Width (in)	Static Loaded Width (in)	Static Loaded Radius (in)	Flat Plate Area (in ²)	Tread Depth (32 nd in)	Rated Load @ Inflation (lbs @ psi)	Weight (lbs)
14.00R24TG	WE	PGW1R4	G-2	153A8	1*	10.00VA	53.5	14.7	16.9	24.1	198	32	8,050 @ 54	245



TITAN TGS2 (G-2) or (G-2/L-2)

- All-season tread pattern
- Aggressive tread pattern and siping provides excellent traction on all surfaces and conditions, especially snow, ice and mud
- Steel belted construction (17.5R25 only) to provide increased cut resistance and extended wear



Tire Size	Compound/ Construction	Catalog #	Tread Design	Industry Code	Load/ Speed Index	Load Rating	Recom'd Rim Code	Outside Diameter (in)	Overall Width (in)	Static Loaded Width (in)	Static Loaded Radius (in)	Flat Plate Area (in ²)	Tread Depth (32 nd in)	Rated Load @ Inflation (lbs @ psi)	Weight (lbs)
14.00R24TG	WE	PSW2R4	A	G-2	162A8	2*	10.00 / 1.7	53.5	15.8	17.6	24.5	181	32	10,500 @ 80	299
17.5R25	WE	ESWB17	B	G-2	162A8	2*	14.00 / 1.5	53.3	18.0	20.0	24.8	248	32	10,500 @ 65	361
				L-2	176A2	1*		53.3	18.0	20.8	24.3	284			





TITAN TGL2 (G-2/L-2)

- Non-directional tread pattern provides long tread life
- Open tread pattern provides excellent self-cleaning and traction
- Steel belted construction to provide increased cut resistance and extended wear



Tire Size	Compound/ Construction	Catalog #	Industry Code	Load/ Speed Index	Load Rating	Recom'd Rim Code	Outside Diameter (in)	Overall Width (in)	Static Loaded Width (in)	Static Loaded Radius (in)	Flat Plate Area (in ²)	Tread Depth (32 nd in)	Rated Load @ Inflation (lbs @ psi)	Weight (lbs)
17.5R25	WE	EUWA17	G-2	153A8	1*	14.00 / 1.5	52.6	17.5	19.5	23.5	230	35	8,050 @ 44	331
			L-2	176A2			52.6	17.5	20.0	24.0	191		15,700 @ 73	



TITAN MXL (L-3)



Key Benefits

- Large contact area for improved wear
- Lug design offers increased biting edges
- Aggressive tread for optimal traction
- Sturdy tread elements for maximum torque transmission
- Poly-belted construction ideal for lighter duty loader applications



Application(s)



LIGHTER DUTY APPLICATIONS

USED IN: MUNICIPAL/FEED LOT LOADERS/GRADERS

Tire Size	Compound/Construction	Catalog #	Industry Code	Load/Speed Index	Load Rating	Recom'd Rim Code	Outside Diameter (in)	Overall Width (in)	Static Loaded Width (in)	Static Loaded Radius (in)	Flat Plate Area (in ²)	Tread Depth (32 nd in)	Rated Load @ Inflation (lbs @ psi)	Weight (lbs)
17.5R25	Poly	4LP117	L-3	176A2	1*	14.00 / 1.5	54.0	18.0	20.5	23.8	268	39	15,700 @ 73	307
20.5R25	Poly	4LP121	L-3	186A2	1*	17.00 / 2.0	59.5	20.9	24.5	26.3	355	48	20,900 @ 73	468
23.5R25	Poly	4LP123	L-3	195A2	1*	19.50 / 2.5	64.7	24.3	28.3	27.9	461	51	26,800 @ 73	635





TITAN STL2+ (E-3T/L-3T)

- 130% level tread depth provides long tread life
- Open, non-directional tread pattern provides excellent self-cleaning
- Bar lug design for rock and traction
- Steel belted construction to provide increased cut resistance and extended wear



Tire Size	Compound/Construction	Catalog #	Industry Code	Load/Speed Index	Load Rating	Recom'd Rim Code	Outside Diameter (in)	Overall Width (in)	Static Loaded Width (in)	Static Loaded Radius (in)	Flat Plate Area (in ²)	Tread Depth (32" ⁱⁿ)	Rated Load @ Inflation (lbs @ psi)	Weight (lbs)
26.5R25	WE	EPWB27	E-3T	193B	2*	22.00 / 3.0	68.9	28.4	30.1	30.7	481	56	25,400 @ 76	923
			L-3T	202A2	1*		68.9	28.4	30.9	29.7	550	33,100 @ 73		
29.5R25	CE	EPTB29	E-3T	200B	2*	25.00 / 3.5	73.3	29.5	33.1	32.8	543	60	30,900 @ 76	1,264
			L-3T	208A2	1*		73.3	29.5	34.0	31.7	608	39,700 @ 73		
29.5R25	WE	EPWB29	E-3T	200B	2*	25.00 / 3.5	73.3	29.5	33.1	32.8	543	60	30,900 @ 76	1,257
			L-3T	208A2	1*		73.3	29.5	34.0	31.7	608	39,700 @ 73		



TITAN STTR (E-3/L-3) or (G-3/L-3)

- Steel ply radial construction
- Steel belted for long-term strength and cut resistance
- Dual rated for both Earthmover and Loader speeds for a more versatile tire option
- Non-directional tread pattern
- Center lug with connecting tie-bars for uniform tread wear and increased stability



Tire Size	Compound/Construction	Catalog #	Industry Code	Load/Speed Index	Load Rating	Recom'd Rim Code	Outside Diameter (in)	Overall Width (in)	Static Loaded Width (in)	Static Loaded Radius (in)	Flat Plate Area (in ²)	Tread Depth (32" ⁱⁿ)	Rated Load @ Inflation (lbs @ psi)	Weight (lbs)
17.5R25	Steel	4S7117001	G-3	153A8	1*	14.00 / 1.5	52.8	17.9	20.1	24.0	234	32	8,050 @ 44	337
			L-3	176A2			53.0	17.9	20.7	23.4	284	15,700 @ 73		
20.5R25	Steel	4S7221001	E-3	177B	2*	17.00 / 2.0	59.2	20.7	23.3	27.0	300	40	16,100 @ 76	527
			L-3	186A2	1*		59.2	20.7	24.0	26.3	354	20,900 @ 73		
23.5R25	Steel	4S7223001	E-3	185B	2*	19.50 / 2.5	63.5	24.2	27.3	27.9	405	42	20,400 @ 76	688
			L-3	195A2	1*		63.5	24.2	28.2	26.9	482	26,800 @ 73		

TITAN STL3 (E-3/L-3)

Key Benefits

- Non-directional tread pattern
- Center riding rib for smooth ride and long, even wear
- Full-width shoulder lug for excellent traction and lateral stability
- Additional compounds available upon request
- Steel belted construction to provide increased cut resistance and extended wear



Application(s)



HEAVY DUTY APPLICATIONS

VERSATILE FOR MULTIPLE APPLICATIONS

USED IN: QUARRIES AND ASPHALT PLANTS

Tire Size	Compound/Construction	Catalog #	Industry Code	Load/Speed Index	Load Rating	Recom'd Rim Code	Outside Diameter (in)	Overall Width (in)	Static Loaded Width (in)	Static Loaded Radius (in)	Flat Plate Area (in ²)	Tread Depth (32 nd in)	Rated Load @ Inflation (lbs @ psi)	Weight (lbs)
20.5R25	CE	ERTB21	E-3	177B	2*	17.00 / 2.0	59.0	21.0	23.3	26.8	296	42	16,100 @ 76	596
			L-3	186A2	1*		58.9	21.0	24.0	26.0	343	42	20,900 @ 73	
23.5R25	CE	ERTB23	E-3	185B	2*	19.50 / 2.5	63.2	24.5	27.2	28.7	358	44	20,400 @ 76	761
			L-3	195A2	1*		63.2	24.5	27.8	27.9	406	44	26,800 @ 73	
26.5R25	CE	ERTB27	E-3	193B	2*	22.00 / 3.0	68.2	27.8	30.4	31.0	443	48	25,400 @ 76	904
			L-3	202A2	1*		68.2	27.7	31.3	30.1	508	48	33,100 @ 73	
750/65R25	WE	ERWBW1	E-3	190B	2*	24.00 / 3.0	63.2	30.3	32.6	28.2	465	58	23,400 @ 62	919
			L-3	202A2	1*		63.3	30.3	32.8	27.3	519	58	33,100 @ 69	
29.5R25	CE	ERTB29	E-3	200B	2*	25.00 / 3.5	73.0	30.6	33.4	33.1	525	55	30,900 @ 76	1,232
			L-3	208A2	1*		73.0	30.6	34.2	32.2	613	55	39,700 @ 73	
875/65R29	WE	ERWDM7	E-3	203B	2*	28.00 / 3.5	73.3	35.2	37.6	33.3	629	60	34,200 @ 69	1,398
			L-3	214A2	1*		73.3	35.2	37.6	32.4	701	60	46,700 @ 69	





TITAN DTH4 (E-4)

- Deep tread depth for long tread life
- Solid center and large contact area provide damage resistance
- Self-cleaning grooves provide excellent traction
- Steel belted construction to provide increased cut resistance and extended wear
- Additional compounds available upon request



Tire Size	Compound/Construction	Catalog #	Industry Code	Load/Speed Index	Load Rating	Recom'd Rim Code	Outside Diameter (in)	Overall Width (in)	Static Loaded Width (in)	Static Loaded Radius (in)	Flat Plate Area (in ²)	Tread Depth (32 nd in)	Rated Load @ Inflation (lbs @ psi)	TMPH	Weight (lbs)
24.00R35	HE	EHH2R7	E-4	209B	2*	17.00 / 3.5	85.8	26.7	29.9	39.1	533	70	40,800 @ 102	310	1,716



TITAN 007 MFT (E-4) or (E-4+)

- Large contact area provides damage resistance
- Self-cleaning grooves provide excellent traction
- Tie-bars provide lug stabilization, resulting in even tread wear
- Steel belted construction to provide increased cut resistance and extended wear



Tire Size	Compound/Construction	Catalog #	Tread Design	Industry Code	Load/Speed Index	Load Rating	Recom'd Rim Code	Outside Diameter (in)	Overall Width (in)	Static Loaded Width (in)	Static Loaded Radius (in)	Flat Plate Area (in ²)	Tread Depth (32 nd in)	Rated Load @ Inflation (lbs @ psi)	TMPH	Weight (lbs)
27.00R49	H2	MH22R9	A	E-4	223B	2*	19.50 / 4.0	106.7	28.6	33.2	48.7	769	86	60,000 @ 102	411	2,894
33.00R51	H2	MH22R3	A	E-4	235B	2*	24.00 / 5.0	120.5	35.2	N/A	N/A	N/A	98	85,500 @ 102	540	4,449
37.00R57	H2	MH2237	A	E-4+	245B	2*	27.00 / 6.0	135.8	39.6	45.5	61.3	1,427	125	113,500 @ 102	681	6,151
40.00R57	H2	MH2240	A	E-4	250B	2*	29.00 / 6.0	142.1	43.1	50.0	63.8	1,577	105	132,500 @ 102	772	7,370
46/90R57	H2	MH2276	A	E-4	252B	2*	32.00 / 6.0	142.1	46.0	N/A	N/A	N/A	105	139,000 @ 102	810	7,552
50/80R57	H4	MH4270	B	E-4	257B	2*	34.00 / 6.0	142.5	48.2	54.6	62.8	1,945	105	161,000 @ 110	725	8,158



TITAN LDR 150 (L-4)

- Non-directional deep tread depth provides extended tread life and excellent cut resistance
- Solid centerline tread pattern provides a stable, smooth ride and additional resistance to rock-type damage
- Steel belted construction to provide increased cut resistance and extended wear



Tire Size	Compound/Construction	Catalog #	Industry Code	Load/Speed Index	Load Rating	Recom'd Rim Code	Outside Diameter (in)	Overall Width (in)	Static Loaded Width (in)	Static Loaded Radius (in)	Flat Plate Area (in ²)	Tread Depth (32 nd in)	Rated Load @ Inflation (lbs @ psi)	Weight (lbs)
58/80R63	WE	LF4258	L-4	276A2	2*	47.00 / 6.0	152.0	54.9	63.8	66.2	2,665	119	275,500 @ 102	10,881



Tread A

Tread B

Tread C



TITAN LDR 250 (L-5)

- Extra deep tread provides excellent rock-type damage resistance and long tread life
- Open non-directional tread pattern provides all-around traction with excellent self-cleaning
- Tread C - Aggressive tread pattern and siping provides excellent traction on all surfaces and conditions especially snow, ice and mud
- Steel belted construction to provide increased cut resistance and extended wear

Tire Size	Compound/Construction	Catalog #	Tread Design	Industry Code	Load/Speed Index	Load Rating	Recom'd Rim Code	Outside Diameter (in)	Overall Width (in)	Static Loaded Width (in)	Static Loaded Radius (in)	Flat Plate Area (in ²)	Tread Depth (32" ² in)	Rated Load @ Inflation (lbs @ psi)	Weight (lbs)
29.5R29	WV	LWV2U2	C	L-5	218A2	2*	25.00 / 3.5	77.1	29.8	33.1	34.2	705	121	52,000 @ 94	1,850
35/65R33	WE	LFT26K	A	L-5	224A2	2*	28.00 / 3.5	81.6	33.1	37.7	36.2	730	115	61,500 @ 94	2,451
45/65R45	WE	LFT26P	A	L-5	245A2	2*	36.00 / 4.5	107.7	43.1	47.5	47.4	1,315	140	113,500 @ 94	5,128
50/65R51	WE	LFT2G6	B	L-5	253A2	2*	40.00 / 4.5	120.0	50.0	53.0	54.5	1,500	160	143,500 @ 94	7,443





TITAN CM 100 (E-3) or (E-3/L-3)

- Rock service tread designed for the challenges of large equipment demands
- Solid centerline tread pattern provides excellent cut resistance, smooth ride and extended wear
- CRB – Features Aralon™ Cut Resistant Breaker construction, which provides increased strength and durability without sacrificing heat resistance



Tire Size	Compound/Construction	Catalog #	Industry Code	Load/Speed Index	Load Rating	Recom'd Rim Code	Outside Diameter (in)	Overall Width (in)	Static Loaded Width (in)	Static Loaded Radius (in)	Flat Plate Area (in ²)	Tread Depth (32" ⁱⁿ)	Rated Load @ Inflation (lbs @ psi)	Weight (lbs)
37.5-39	CRB	6M1HW9	E-3	222B	52	32.00 / 4.5	98.5	38.2	40.0	44.4	853	66	56,800 @ 69	2,741
37.5-39	CRB	6M2NW9	E-3	225B	60	32.00 / 4.5	98.6	38.2	40.0	44.5	842	66	64,000 @ 80	2,734
			L-3	241A2			98.7							



TITAN ND LCM (E-3) or (E-3/L-3)

- Non-directional tread design with center riding rib provides excellent all-around traction and lateral stability
- Rock service tread design provides resistance to rock damage and long tread life
- CRB – Features an Aralon™ Cut Resistant Breaker construction, which provides increased strength and durability without sacrificing heat resistance



Tire Size	Compound/Construction	Catalog #	Industry Code	Load/Speed Index	Load Rating	Recom'd Rim Code	Outside Diameter (in)	Overall Width (in)	Static Loaded Width (in)	Static Loaded Radius (in)	Flat Plate Area (in ²)	Tread Depth (32" ⁱⁿ)	Rated Load @ Inflation (lbs @ psi)	Weight (lbs)
18.00-25	--	6NDW18	E-3	183B	32	13.00 / 2.5	64.2	20.2	21.6	29.3	255	39	19,300 @ 83	631
20.5-25	--	6NNR21	E-3	174B	24	17.00 / 2.0	58.0	21.2	22.3	26.3	254	35	14,800 @ 58	466
			L-3	189A2			58.3	21.4	22.7	25.9	302	22,700 @ 76		
23.5-25	--	6NN923	E-3	177B	20	19.50 / 2.5	63.3	24.5	26.0	28.0	403	39	16,100 @ 44	527
			L-3	191A2			63.4	24.7	26.4	27.3	490	24,000 @ 54		
23.5-25	--	6NNR23	E-3	180B	24	19.50 / 2.5	62.7	24.2	25.3	27.8	409	39	17,600 @ 51	585
			L-3	196A2			63.4	24.6	26.2	27.4	449	27,600 @ 69		
26.5-25	--	6NNT27	E-3	186B	26	22.00 / 3.0	68.1	27.6	29.1	29.9	458	43	20,900 @ 47	847
			L-3	202A2			68.5	27.8	29.5	29.3	543	33,100 @ 65		
26.5-25	--	6NNW27	E-3	191B	32	22.00 / 3.0	69.0	27.9	28.7	31.2	346	43	24,000 @ 58	911
			L-3	206A2			69.0	28.1	29.2	30.5	491	37,500 @ 80		
26.5-25	--	6NND27	E-3	198B	44	22.00 / 3.0	68.6	27.2	27.6	31.5	325	43	29,100 @ 83	1,003
			L-3	213A2			68.7	27.2	28.0	30.8	425	45,400 @ 112		
29.5-25	--	6NNUW1	E-3	193B	28	25.00 / 3.5	74.5	30.1	31.5	32.9	504	47	25,400 @ 47	1,014
			L-3	207A2			74.7	30.2	32.1	32.2	656	38,600 @ 62		
29.5-25	--	6NNXW1	E-3	198B	34	25.00 / 3.5	74.6	30.2	31.6	32.9	495	47	29,100 @ 58	1,090
			L-3	212A2			74.8	30.4	32.1	32.2	603	44,100 @ 76		
29.5-29	--	6NNXW2	E-3	200B	34	25.00 / 3.5	78.3	30.2	31.8	34.8	563	47	30,900 @ 58	1,136
			L-3	214A2			78.5	30.4	32.3	34.0	634	46,700 @ 76		
29.5-35	--	6NDXW3	E-3	202B	34	25.00 / 3.5	83.0	30.2	31.7	37.7	472	47	33,100 @ 58	1,319

Continues on Next Page



ND LCM Continued

Tire Size	Compound/Construction	Catalog #	Industry Code	Load/Speed Index	Load Rating	Recom'd Rim Code	Outside Diameter (in)	Overall Width (in)	Static Loaded Width (in)	Static Loaded Radius (in)	Flat Plate Area (in ²)	Tread Depth (32 nd in)	Rated Load @ Inflation (lbs @ psi)	Weight (lbs)
33.25-35	CRB	6NNKW5	E-3	217B	56	27.00 / 3.5	89.2	33.3	34.7	40.2	570	53	50,700 @ 87	1,939
			L-3	232A2			89.8	33.5	35.3	39.4	729		78,500 @ 112	
33.5-33	CRB	6NDDW6	E-3	212B	44	28.00 / 4.0	88.1	34.4	36.0	39.4	716	53	44,100 @ 65	1,864
37.5-33	CRB	6NNMW8	E-3	221B	54	32.00 / 4.5	93.7	38.3	39.0	42.2	718	58	56,800 @ 73	2,399
			L-3	235A2			93.7	38.3	39.0	42.2	718		85,500 @ 94	



TITAN SL 100 (E-3) or (E-3/L-3)

- Center riding rib provides a smooth ride and improved lateral stability
- Non-directional tread design pattern provides excellent all-around traction and long wear
- CRB – Features an Aralon** Cut Resistant Breaker construction, which provides increased strength and durability without sacrificing heat resistance



Tire Size	Compound/Construction	Catalog #	Industry Code	Load/Speed Index	Load Rating	Recom'd Rim Code	Outside Diameter (in)	Overall Width (in)	Static Loaded Width (in)	Static Loaded Radius (in)	Flat Plate Area (in ²)	Tread Depth (32 nd in)	Rated Load @ Inflation (lbs @ psi)	Weight (lbs)
33.25-29	CRB	6SLWW4	E-3	202B	32	27.00 / 3.5	82.4	33.7	35.8	36.7	685	53	33,100 @ 47	1,478
			L-3	218A2			82.5	33.8	36.5	35.9	849		52,000 @ 65	
33.25-29	CRB	6SLAW4	E-3	205B	38	27.00 / 3.5	82.5	33.8	35.7	36.9	663	53	36,400 @ 58	1,558
			L-3	221A2			82.7	34.0	36.4	36.0	821		56,800 @ 76	
37.25-35	CRB	6SLZW7	E-3	211B	36	29.00 / 3.5	95.4	36.9	39.1	42.5	841	58	43,000 @ 47	2,186



TITAN SUPER RIGGER (E-3/L-3)

- Non-directional wide tread
- Long wearing tread compound for demanding material handling operations



Tire Size	Catalog #	Industry Code	Load/Speed Index	Load Rating	Recom'd Rim Code	Outside Diameter (in)	Overall Width (in)	Static Loaded Width (in)	Static Loaded Radius (in)	Flat Plate Area (in ²)	Tread Depth (32 nd in)	Rated Load @ Inflation (lbs @ psi)	Weight (lbs)
13.00-24TG	49L333	E-3	146B	12	9.00	50.4	14.7	N/A	23.1	152	31	6,600 @ 44	225
		L-3	168A2			49.9	14.6	15.8	22.7	195		12,300 @ 65	
14.00-24TG	49L344	E-3	150B	12	10.00	52.3	14.8	16.8	24.2	175	32	7,400 @ 40	222
		L-3	172A2			53.4	14.0	N/A	23.7	240		13,900 @ 62	
14.00-25NHS	49LB65	E-3	168B	28	10.00 / 1.5	53.4	15.2	N/A	25.1	172	32	12,300 @ 94	378
		L-3	189A2			53.4	15.2	16.3	24.5	229		22,700 @ 141	



TITAN XG-3 (E-3)

- All-purpose design for traction and flotation
- Solid centerline provides excellent lateral stability
- CRB – Features an Aralon™ Cut Resistant Breaker construction, which provides increased strength and durability without sacrificing heat resistance



Tire Size	Compound/ Construction	Catalog #	Industry Code	Load/ Speed Index	Load Rating	Recom'd Rim Code	Outside Diameter (in)	Overall Width (in)	Static Loaded Width (in)	Static Loaded Radius (in)	Flat Plate Area (in ²)	Tread Depth (32 nd in)	Rated Load @ Inflation (lbs @ 47)	Weight (lbs)
37.25-35	CRB	6X3ZW7	E-3	211B	36	29.00 / 3.5	95.2	37.5	39.9	42.1	902	58	43,000 @ 47	2,195



TITAN CH 150 (E-4/L-4)

- Deep, non-directional tread provides excellent rock-type damage and long tread life
- Solid centerline tread pattern provides smooth ride and excellent lateral traction



Tire Size	Catalog #	Industry Code	Load/ Speed Index	Load Rating	Recom'd Rim Code	Outside Diameter (in)	Overall Width (in)	Static Loaded Width (in)	Static Loaded Radius (in)	Flat Plate Area (in ²)	Tread Depth (32 nd in)	Rated Load @ Inflation (lbs @ psi)	Weight (lbs)
18.00-25	6HLB18	E-4	187B	40	13.00 / 2.5	65.0	20.3	21.2	30.4	281	66	21,500 @ 102	856
		L-4	206A2			65.1	20.4	21.7	29.7	360		37,500 @ 138	



TITAN CM 150 (E-4) or (E-4/L-4)

- Deep, non-directional tread provides excellent rock-type damage resistance and long tread life
- Solid centerline tread pattern provides smooth ride and excellent lateral traction on high tonnage vehicles
- CRB – Features Aralon™ Cut Resistant Breaker construction, which provides increased strength and durability without sacrificing heat resistance



Tire Size	Compound/ Construction	Catalog #	Industry Code	Load/ Speed Index	Load Rating	Recom'd Rim Code	Outside Diameter (in)	Overall Width (in)	Static Loaded Width (in)	Static Loaded Radius (in)	Flat Plate Area (in ²)	Tread Depth (32 nd in)	Rated Load @ Inflation (lbs @ psi)	Weight (lbs)
18.00-33	--	6M5B83	E-4	193B	40	13.00 / 2.5	74.3	20.1	21.4	34.9	331	71	25,400 @ 102	1,087
			L-4	212A2			74.5	20.2	22.4	34.2	428		44,100 @ 138	
33.25-35	CRB	6M5DW5	E-4	211B	44	27.00 / 3.5	90.0	34.1	35.9	41.2	659	78	43,000 @ 65	2,427
33.25-35	CRB	6MLKW5	E-4	217B	56	27.00 / 3.5	90.3	34.4	N/A	N/A	N/A	78	50,700 @ 87	2,530
			L-4	232A2			N/A	N/A	N/A	N/A	78,500 @ 112			
37.25-35	CRB	6M5ZW7	E-4	211B	36	29.00 / 3.5	94.3	36.5	39.1	42.4	820	87	43,000 @ 47	2,445

TITAN QUARRY SPECIAL (E-4) or (E-4/L-4)

Key Benefits

- “Value Engineered” VE-420 tread designed for excellent chip and cut resistance from shot rock
- Tread designed for traction with deep lugs and center riding rib for a smoother ride
- CRB – Features Aralon®* Cut Resistant Breaker construction, which provides increased strength and durability without sacrificing heat resistance



Application(s)

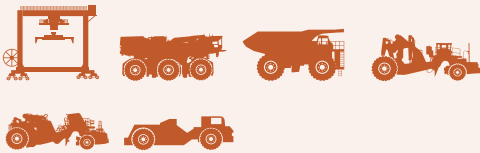

DUAL RATED DESIGNS FOR INDUSTRIAL APPLICATIONS

USED IN: QUARRIES, SMALL OPEN PITS, PORT RAILYARDS & STEEL MILLS

Tire Size	Compound/Construction	Catalog #	Industry Code	Load/Speed Index	Load Rating	Recom'd Rim Code	Outside Diameter (in)	Overall Width (in)	Static Loaded Width (in)	Static Loaded Radius (in)	Flat Plate Area (in ²)	Tread Depth (32" in)	Rated Load @ Inflation (lbs @ psi)	Weight (lbs)
18.00-33	VE-420,CRB	6QSW83	E-4	189B	32	13.00 / 2.5	74.1	20.7	21.8	34.7	293	71	22,700 @ 83	955
21.00-35	VE-420,CRB	6QSC25	E-4	201B	42	15.00 / 3.0	82.2	23.7	24.7	37.2	475	71	32,000 @ 94	1,448
			L-4	219A2			82.3	23.1	25.1	35.5	624		53,600 @ 123	
24.00-35	VE-420,CRB	6QSF43	E-4	209B	48	17.00 / 3.5	81.1	23.6	27.8	39.6	428	70	40,800 @ 94	1,717
			L-4	228A2			N/A	N/A	N/A	N/A	N/A		69,500 @ 127	
24.00-49	VE-420,CRB	6QSF49	E-4	215B	48	17.00 / 3.5	100.8	26.5	28.0	46.9	532	70	48,100 @ 94	2,178
			L-4	222A2			100.9	26.9	29.0	45.8	718		85,500 @ 127	
27.00-49	VE-420,CRB	6QSF79	E-4	220B	48	19.50 / 4.0	105.8	30.8	32.9	48.9	684	78	55,100 @ 83	2,627
			L-4	239A2			106.1	31.0	34.0	47.6	901		96,500 @ 112	
30.00-51	VE-420,CRB	6QSH30	E-4	226B	52	22.00 / 4.5	114.4	32.5	34.8	52.7	816	85	66,000 @ 80	3,699
			L-4	246A2			114.4	32.5	34.8	52.7	816		117,000 @ 109	
33.00-51	VE-420,CRB	6QSJ35	E-4	232B	58	24.00 / 5.0	119.1	35.9	38.2	54.7	1053	98	78,500 @ 83	4,013
36.00-51	VE-420,CRB	6QSJ36	E-4	237B	58	26.00 / 5.0	127.9	40.0	42.3	58.9	1202	100	91,000 @ 76	5,641
			L-4	256A2			128.1	40.0	44.1	56.2	1536		156,500 @ 98	



REDUCED DOWNTIME



INCREASED PUNCTURE RESISTANCE



IMPROVED TREAD WEAR



INCREASED CUT RESISTANCE



TITAN HK 458 (E-4/L-4)

- A new, deep-tread, directional, pattern designed to provide greater traction for the most extreme wheel loader conditions
- Premium tread compound resistant to chunking/tearing paired to a high-stability lug design
- The proven cavity shape protects the sidewall throughout the footprint and fits on the standard OTR rim
- Steel belted construction provides maximum penetration resistance



Tire Size	Compound/Construction	Catalog #	Industry Code	Load/Speed Index	Load Rating	Recom'd Rim Code	Outside Diameter (in)	Overall Width (in)	Static Loaded Width (in)	Static Loaded Radius (in)	Flat Plate Area (in ²)	Tread Depth (32 nd in)	Rated Load @ Inflation (lbs @ psi)	Weight (lbs)
20.5-25	Steel	6HK921	E-4	170B	20	17.00 / 2.0	59.2	20.0	21.5	26.8	328	62	13,200 @ 47	459
			L-4	186A2			59.3	20.3	21.9	26.2	401			
23.5-25	Steel	6HK923	E-4	177B	20	19.50 / 2.5	63.2	23.0	24.5	28.4	453	68	16,100 @ 44	578
			L-4	191A2			63.2	23.1	25.0	27.7	513			



TITAN ND SUPER LCM (E-4) or (E-4/L-4)

- Non-directional tread design with center riding rib provides excellent all-around traction and lateral stability
- Increased tread depth provides extended tread life and exceptional resistance to rock-type damage



Tire Size	Catalog #	Industry Code	Load/Speed Index	Load Rating	Recom'd Rim Code	Outside Diameter (in)	Overall Width (in)	Static Loaded Width (in)	Static Loaded Radius (in)	Flat Plate Area (in ²)	Tread Depth (32 nd in)	Rated Load @ Inflation (lbs @ psi)	Weight (lbs)
18.00-25	6U4W18	E-4	183B	32	13.00 / 2.5	65.3	20.0	21.0	30.2	248	66	19,300 @ 83	738
18.00-25	6UNB18	E-4	187B	40	13.00 / 2.5	65.4	20.1	21.0	30.2	242	66	21,500 @ 102	785
		L-4	206A2			65.4	20.2	21.7	29.4	327			



TITAN SUPER SAND FLOTATION (E-7)

- Rib design provides excellent steering stability and improved lateral traction
- Shallow tread depth provides excellent heat dissipation
- Designed for paving applications



Tire Size	Catalog #	Industry Code	Load/Speed Index	Load Rating	Recom'd Rim Code	Outside Diameter (in)	Overall Width (in)	Static Loaded Width (in)	Static Loaded Radius (in)	Flat Plate Area (in ²)	Tread Depth (32 nd in)	Rated Load @ Inflation (lbs @ psi)	Weight (lbs)
16.00-24DT	6DT1D6	E-7	182A2	12	10.00	57.5	18.8	21.2	23.2	447	14	18,700 @ 44	262



TITAN MOTOR GRADER HD (G-2)

- Proven performance tread design with massive lugs, large center overlap to resist buckling, tearing and cracking
- Very durable and resistant to punctures, features a heavy duty tubeless construction



Tire Size	Catalog #	Industry Code	Load/Speed Index	Load Rating	Recom'd Rim Code	Outside Diameter (in)	Overall Width (in)	Static Loaded Width (in)	Static Loaded Radius (in)	Flat Plate Area (in ²)	Tread Depth (32 nd in)	Rated Load @ Inflation (lbs @ psi)	Weight (lbs)
13.00-24TG	367333	G-2	143A8	12	9.00	50.5	14.2	N/A	23.7	150	29	6,000 @ 44	163
13.00-24TG	36738A	G-2	149A8	16	9.00	51.5	14.4	N/A	23.6	160	29	7,150 @ 54	179
14.00-24TG	367344	G-2	147A8	12	9.00	54.3	15.2	N/A	26.0	179	31	6,800 @ 36	200
14.00-24TG	3673R4	G-2	153A8	16	10.00	54.0	15.7	15.7	N/A	205	31	8,050 @ 51	215



TITAN LOADER GRADER III (G-2)

- Interlocking center lugs provide excellent steering stability in soft ground
- Open shoulders provide excellent traction and self-cleaning



Tire Size	Catalog #	Industry Code	Load/Speed Index	Load Rating	Recom'd Rim Code	Outside Diameter (in)	Overall Width (in)	Static Loaded Width (in)	Static Loaded Radius (in)	Flat Plate Area (in ²)	Tread Depth (32 nd in)	Rated Load @ Inflation (lbs @ psi)	Weight (lbs)
13.00-24TG	LG3333	G-2	143A6	12	8.00	51.0	14.1	N/A	23.4	175	29	6,000 @ 44	152
14.00-24TG	LG3344	G-2	172A2	12	8.00	54.2	14.4	16.6	23.4	263	31	13,900 @ 62	172





TITAN LOADER DOZER II (L-2)

- Exceptional performance rating and heavy duty ply ratings
- Laterally designed lugs provide maximum, even traction along the length of lug
- Lugs resist buckling, cracking and tearing



Tire Size	Catalog #	Industry Code	Load/Speed Index	Load Rating	Recom'd Rim Code	Outside Diameter (in)	Overall Width (in)	Static Loaded Width (in)	Static Loaded Radius (in)	Flat Plate Area (in ²)	Tread Depth (32 nd in)	Rated Load @ Inflation (lbs @ psi)	Weight (lbs)
15.5-25	431120	L-2	168A2	12	12.00 / 1.3	50.0	15.3	17.0	22.4	222	29	12,300 @ 58	195
17.5-25	431117	L-2	171A2	12	14.00 / 1.5	52.1	17.8	18.9	23.2	276	32	13,600 @ 51	224
20.5-25	431521	L-2	181A2	16	17.00 / 2.0	57.9	21.1	N/A	25.5	353	36	18,200 @ 51	360
20.5-25	431921	L-2	186A2	20	17.00 / 2.0	58.1	21.2	N/A	25.5	381	36	20,900 @ 65	375
23.5-25	431923	L-2	191A2	20	19.50 / 2.5	63.7	23.7	25.4	27.9	426	38	24,000 @ 54	508



TITAN CM 100 (E-3/L-3)

- Rock service tread designed for the challenges of large equipment demands
- Solid centerline tread pattern provides excellent cut resistance, smooth ride and extended wear
- CRB – Features Aralon™ Cut Resistant Breaker construction, which provides increased strength and durability without sacrificing heat resistance



Tire Size	Compound/Construction	Catalog #	Industry Code	Load/Speed Index	Load Rating	Recom'd Rim Code	Outside Diameter (in)	Overall Width (in)	Static Loaded Width (in)	Static Loaded Radius (in)	Flat Plate Area (in ²)	Tread Depth (32 nd in)	Rated Load @ Inflation (lbs @ psi)	Weight (lbs)
37.5-39	CRB	6M2NW9	E-3	225B	60	32.00 / 4.5	98.6	38.2	40.0	44.5	842	66	64,000 @ 80	2,734
			L-3	241A2			98.7	38.3	40.9	43.5	1019	102,000 @ 109		





TITAN SL 100 (E-3/L-3)

- Center riding rib provides a smooth ride and improved lateral stability
- Non-directional tread design pattern provides excellent all-around traction and long wear
- CRB – Features Aralon™* Cut Resistant Breaker construction, which provides increased strength and durability without sacrificing heat resistance



Tire Size	Compound/Construction	Catalog #	Industry Code	Load/Speed Index	Load Rating	Recom'd Rim Code	Outside Diameter (in)	Overall Width (in)	Static Loaded Width (in)	Static Loaded Radius (in)	Flat Plate Area (in ²)	Tread Depth (32 nd in)	Rated Load @ Inflation (lbs @ psi)	Weight (lbs)
33.25-29	CRB	6SLWW4	E-3	202B	32	27.00 / 3.5	82.4	33.7	35.8	36.7	685	53	33,100 @ 47	1,478
			L-3	218A2			82.5	33.8	36.5	35.9	849		52,000 @ 65	
33.25-29	CRB	6SLAW4	E-3	205B	38	27.00 / 3.5	82.5	33.8	35.7	36.9	663	53	36,400 @ 58	1,558
			L-3	221A2			82.7	34.0	36.4	36.0	821		56,800 @ 76	



TITAN ND LCM (E-3/L-3) or (L-3)

- Non-directional tread design with center riding rib provides excellent all-around traction and lateral stability
- Rock service tread design provides resistance to rock damage and long tread life
- CRB – Features Aralon™* Cut Resistant Breaker construction, which provides increased strength and durability without sacrificing heat resistance



Tire Size	Compound/Construction	Catalog #	Industry Code	Load/Speed Index	Load Rating	Recom'd Rim Code	Outside Diameter (in)	Overall Width (in)	Static Loaded Width (in)	Static Loaded Radius (in)	Flat Plate Area (in ²)	Tread Depth (32 nd in)	Rated Load @ Inflation (lbs @ psi)	Weight (lbs)
16.00-25	--	6N3W65	L-3	196A2	32	11.25 / 2.0	59.3	17.5	19.2	26.6	258	35	27,600 @ 127	499
20.5-25	--	6NNR21	E-3	174B	24	17.00 / 2.0	58.0	21.2	22.3	26.3	254	35	14,800 @ 58	466
			L-3	189A2			58.3	21.4	22.7	25.9	302		22,700 @ 76	
23.5-25	--	6NN923	E-3	177B	20	19.50 / 2.5	63.3	24.5	26.0	28.0	403	39	16,100 @ 44	527
			L-3	191A2			63.4	24.7	26.4	27.3	490		24,000 @ 54	
23.5-25	--	6NNR23	E-3	180B	24	19.50 / 2.5	62.7	24.2	25.3	27.8	409	39	17,600 @ 51	585
			L-3	196A2			63.4	24.6	26.2	27.4	449		27,600 @ 69	
26.5-25	--	6NNW27	E-3	191B	32	22.00 / 3.0	69.0	27.9	28.7	31.2	346	43	24,000 @ 58	911
			L-3	206A2			69.0	28.1	29.2	30.5	491		37,500 @ 80	
26.5-25	--	6NND27	E-3	198B	44	22.00 / 3.0	68.6	27.2	27.6	31.5	325	43	29,100 @ 83	1,003
			L-3	213A2			68.7	27.2	28.0	30.8	425		45,400 @ 112	
29.5-25	--	6NNUW1	E-3	193B	28	25.00 / 3.5	74.5	30.1	31.5	32.9	504	47	25,400 @ 47	1,014
			L-3	207A2			74.7	30.2	32.1	32.2	656		38,600 @ 62	
29.5-25	--	6NNXW1	E-3	198B	34	25.00 / 3.5	74.6	30.2	31.6	32.9	495	47	29,100 @ 58	1,090
			L-3	212A2			74.8	30.4	32.1	32.2	603		44,100 @ 76	
29.5-29	--	6NNXW2	E-3	200B	34	25.00 / 3.5	78.3	30.2	31.8	34.8	563	47	30,900 @ 58	1,136
			L-3	214A2			78.5	30.4	32.3	34.0	634		46,700 @ 76	
33.25-35	CRB	6NNKW5	E-3	217B	56	27.00 / 3.5	89.2	33.3	34.7	40.2	570	53	50,700 @ 87	1,939
			L-3	232A2			89.8	33.5	35.3	39.4	729		78,500 @ 112	
37.5-33	CRB	6NNMW8	E-3	221B	54	32.00 / 4.5	93.7	38.3	39.0	42.2	718	58	56,800 @ 73	2,399
			L-3	235A2			93.7	38.3	39.0	42.2	718		85,500 @ 94	

CRB



TITAN SUPER RIGGER (E-3/L-3)

- Non-directional wide tread
- Long wearing tread compound for demanding material handling operations



Tire Size	Catalog #	Industry Code	Load/Speed Index	Load Rating	Recom'd Rim Code	Outside Diameter (in)	Overall Width (in)	Static Loaded Width (in)	Static Loaded Radius (in)	Flat Plate Area (in ²)	Tread Depth (32 nd in)	Rated Load @ Inflation (lbs @ psi)	Weight (lbs)
13.00-24TG	49L333	E-3	146B	12	9.00	50.4	14.7	N/A	23.1	152	31	6,600 @ 44	225
		L-3	168A2			49.9	14.6	15.8	22.7	195		12,300 @ 65	
14.00-24TG	49L344	E-3	150B	12	10.00	52.3	14.8	16.8	24.2	175	32	7,400 @ 40	222
		L-3	172A2			53.4	14.0	N/A	23.7	240		13,900 @ 62	
14.00-25NHS	49LB65	E-3	168B	28	10.00 / 1.5	53.4	15.2	N/A	25.1	172	32	12,300 @ 94	378
		L-3	189A2			53.4	15.2	16.3	24.5	229		22,700 @ 141	



TITAN CH 150 (E-4/L-4)

- Deep, non-directional tread provides excellent rock-type damage and long tread life
- Solid centerline tread pattern provides smooth ride and excellent lateral traction



Tire Size	Catalog #	Industry Code	Load/Speed Index	Load Rating	Recom'd Rim Code	Outside Diameter (in)	Overall Width (in)	Static Loaded Width (in)	Static Loaded Radius (in)	Flat Plate Area (in ²)	Tread Depth (32 nd in)	Rated Load @ Inflation (lbs @ psi)	Weight (lbs)
18.00-25	6HLB18	E-4	187B	40	13.00 / 2.5	65.0	20.3	21.2	30.4	281	66	21,500 @ 102	856
		L-4	206A2			65.1	20.4	21.7	29.7	360		37,500 @ 138	



TITAN CM 150 (E-4/L-4)

- Deep, non-directional tread provides excellent rock-type damage resistance and long tread life
- Solid centerline tread pattern provides smooth ride and excellent lateral traction on high tonnage vehicles
- CRB – Features Aralon* Cut Resistant Breaker construction, which provides increased strength and durability without sacrificing heat resistance



Tire Size	Compound/Construction	Catalog #	Industry Code	Load/Speed Index	Load Rating	Recom'd Rim Code	Outside Diameter (in)	Overall Width (in)	Static Loaded Width (in)	Static Loaded Radius (in)	Flat Plate Area (in ²)	Tread Depth (32 nd in)	Rated Load @ Inflation (lbs @ psi)	Weight (lbs)
33.25-35	CRB	6MLKW5	E-4	217B	56	27.00 / 3.5	90.3	34.4	N/A	N/A	N/A	78	50,700 @ 87	2,530
			L-4	232A2			N/A	N/A	N/A	N/A	78,500 @ 112			



TITAN QUARRY SPECIAL (E-4/L-4)

- “Value Engineered” VE-420 tread designed for excellent chip and cut resistance from shot rock
- Tread designed for traction with deep lugs and center riding rib for a smoother ride
- CRB – Features Aralon™ Cut Resistant Breaker construction, which provides increased strength and durability without sacrificing heat resistance



Tire Size	Compound/Construction	Catalog #	Industry Code	Load/Speed Index	Load Rating	Recom'd Rim Code	Outside Diameter (in)	Overall Width (in)	Static Loaded Width (in)	Static Loaded Radius (in)	Flat Plate Area (in ²)	Tread Depth (32 nd in)	Rated Load @ Inflation (lbs @ psi)	Weight (lbs)
21.00-35	VE-420, CRB	6QSC25	E-4	201B	42	15.00 / 3.0	82.2	23.7	24.7	37.2	475	71	32,000 @ 94	1,448
			L-4	219A2			82.3	23.1	25.1	35.5	624		53,600 @ 123	
24.00-35	VE-420, CRB	6QSF43	E-4	209B	48	17.00 / 3.5	81.1	23.6	27.8	39.6	428	70	40,800 @ 94	1,717
			L-4	228A2			N/A	N/A	N/A	N/A	N/A		69,500 @ 127	
24.00-49	VE-420, CRB	6QSF49	E-4	215B	48	17.00 / 3.5	100.8	26.5	28.0	46.9	532	70	48,100 @ 94	2,178
			L-4	222A2			100.9	26.9	29.0	45.8	718		85,500 @ 127	
27.00-49	VE-420, CRB	6QSF79	E-4	220B	48	19.50 / 4.0	105.8	30.8	32.9	48.9	684	78	55,100 @ 83	2,627
			L-4	239A2			106.1	31.0	34.0	47.6	901		96,500 @ 112	
30.00-51	VE-420, CRB	6QSH30	E-4	226B	52	22.00 / 4.5	114.4	32.5	34.8	52.7	816	85	66,000 @ 80	3,699
			L-4	246A2			114.4	32.5	34.8	52.7	816		117,000 @ 109	
33.00-51	VE-420, CRB	6Q4J35	E-4	232B	58	24.00 / 5.0	119.1	35.9	38.2	54.7	1053	98	78,500 @ 83	4,280
			L-4	252A2			N/A	N/A	N/A	N/A	N/A		139,000 @ 112	
36.00-51	VE-420, CRB	6QSJ36	E-4	237B	58	26.00 / 5.0	127.9	40.0	42.3	58.9	1202	100	91,000 @ 76	5,641
			L-4	256A2			128.1	40.0	44.1	56.2	1536		156,500 @ 98	



TITAN SUPER LCM (L-4)

- Increased tread depth provides extended tread life and exceptional resistance to rock-type damage
- Directional tread design provides excellent traction



Tire Size	Catalog #	Industry Code	Load/Speed Index	Load Rating	Recom'd Rim Code	Outside Diameter (in)	Overall Width (in)	Static Loaded Width (in)	Static Loaded Radius (in)	Flat Plate Area (in ²)	Tread Depth (32 nd in)	Rated Load @ Inflation (lbs @ psi)	Weight (lbs)
16.00-25	6L4W65	L-4	196A2	32	11.25 / 2.0	60.4	17.5	19.0	27.3	284	52	27,600 @ 127	551





REDUCED DOWNTIME



INCREASED PUNCTURE RESISTANCE



INCREASED CUT RESISTANCE



CROSSOVER



INCREASED TRACTION



INCREASED FLOTATION

TITAN HK 458 (E-4/L-4)

Key Benefits

- A new, deep-tread, directional, pattern designed to provide greater traction for the most extreme wheel loader conditions
- Premium tread compound resistant to chunking/tearing paired to a high-stability lug design
- The proven cavity shape protects the sidewall throughout the footprint and fits on the standard OTR rim
- Steel belted construction provides maximum penetration resistance



Application(s)



HYBRID LOADER TIRE FOR EXTREMELY WET & MUCKY CONDITIONS

AGGRESSIVE TRACTION, PHENOMENAL SELF-CLEANING

USED IN: FEEDLOTS, DAIRIES AND LAND DEVELOPMENT

Tire Size	Compound/Construction	Catalog #	Industry Code	Load/Speed Index	Load Rating	Recom'd Rim Code	Outside Diameter (in)	Overall Width (in)	Static Loaded Width (in)	Static Loaded Radius (in)	Flat Plate Area (in ²)	Tread Depth (32" in)	Rated Load @ Inflation (lbs @ psi)	Weight (lbs)
20.5-25	Steel	6HK921	E-4	170B	20	17.00 / 2.0	59.2	20.0	21.5	26.8	328	62	13,200 @ 47	459
			L-4	186A2			59.3	20.3	21.9	26.2	401		20,900 @ 65	
23.5-25	Steel	6HK923	E-4	177B	20	19.50 / 2.5	63.2	23.0	24.5	28.4	453	68	16,100 @ 44	578
			L-4	191A2			63.2	23.1	25.0	27.7	513		24,000 @ 54	



TITAN HK 458 TIRE DEVELOPMENT

Borrowing from tread elements covering multiple applications, the HK 458 has been meticulously engineered to provide unsurpassed strength and durability, tremendous traction in dirt/gravel, and superior self-cleaning, all in a modern aggressive design.



TITAN ND LCM LOWER CAVITY & BEAD AREA

Used on Mobile Cranes, the rugged cavity and bead area of the ND LCM need can withstand massive front end weight and downward pressures when lifting and carrying large loads.

GOODYEAR LOGGER LUG III TREAD DESIGN

There are fewer environments as deadly to tires as the Forest. The Logger Lug III's tread pattern provides amazing traction and self-cleaning to ensure forestry skidders can make it through the worst conditions.

TITAN AT 589 SIPING AND DECK STYLING

Aggressive tread elements borrowed from our ATV tire line the AT 589 provide the modern look and styling to make the HK 458 an innovative powerhouse in the wheel loader tire market.

IMPROVED
PROFITABILITYINCREASED HEAT
RESISTANCECOST
EFFECTIVE

TITAN LD 150 (L-4)

Key Benefits

- Deep tread provides excellent rock-type damage resistance and long tread life
- Non-directional, solid centerline tread pattern provides excellent cut resistance, smooth ride and extended wear
- CRB – Features Aralon[®]* Cut Resistant Breaker construction, which provides increased strength and durability without sacrificing heat resistance
- Belted 7x7 - Features 7x7 steel belted construction, which provides increased cut resistance and extended wear



OFFERS REDUCED HEAT BUILD-UP FOR LONGER WEAR

DEEPER TREAD THAN STANDARD E-3/L-3

USED IN: LOADER APPLICATIONS THAT NEED INCREASED PROTECTION, WHILE MAINTAINING TRAMMABILITY

Application(s)



	Tire Size	Compound/ Construction	Catalog #	Industry Code	Load/ Speed Index	Load Rating	Recom'd Rim Code	Outside Diameter (in)	Overall Width (in)	Static Loaded Width (in)	Static Loaded Radius (in)	Flat Plate Area (in ²)	Tread Depth (32 nd in)	Rated Load @ Inflation (lbs @ psi)	Weight (lbs)
CRB	23.5-25	CRB	6DER23	L-4	196A2	24	19.50 / 2.5	67.6	24.9	26.3	29.9	429	66	27,600 @ 69	751
	29.5-25	CRB	6DEUW1	L-4	207A2	28	25.00 / 3.5	76.2	30.8	33.2	33.6	608	70	38,600 @ 62	1,384
Belted 7x7	35/65-33	Belted 7x7	6DLC6B	L-4	222A2	42	28.00 / 3.5	81.8	35.0	36.4	37.3	657	70	58,400 @ 91	2,336





TITAN LS 150 (L-4T)

- For use on wheel loaders where high flotation and/or extreme traction is required
- Specifically designed for use on a multi-piece OTR wheel
- Open, deep tread pattern provides excellent traction in extreme conditions
- Tread compound designed for increased resistance to tread chunking and tearing
- Steel belted construction provides excellent penetration resistance



Tire Size	Catalog #	Industry Code	Load/Speed Index	Load Rating	Recom'd Rim Code	Outside Diameter (in)	Overall Width (in)	Static Loaded Width (in)	Static Loaded Radius (in)	Flat Plate Area (in ²)	Tread Depth (32 nd in)	Rated Load @ Inflation (lbs @ psi)	Weight (lbs)
725/70-25	LT45M6	L-4T	189A2	16	22.00 / 3.0	65.8	26.9	29.2	27.8	608	72	22,700 @ 36	697

*Replaces 26.5-25



CRB Belted 7x7

TITAN LD 250 (L-5)

- Extra deep tread provides excellent rock-type damage resistance and long tread life
- Open non-directional tread pattern provides all-around traction with excellent self cleaning
- CRB – Features Aralon[™]* Cut Resistant Breaker construction, which provides increased strength and durability without sacrificing heat resistance
- Belted 7x7 - Features 7x7 steel belted construction, which provides increased cut resistance and extended wear



Tire Size	Compound/Construction	Catalog #	Industry Code	Load/Speed Index	Load Rating	Recom'd Rim Code	Outside Diameter (in)	Overall Width (in)	Static Loaded Width (in)	Static Loaded Radius (in)	Flat Plate Area (in ²)	Tread Depth (32 nd in)	Rated Load @ Inflation (lbs @ psi)	Weight (lbs)
CRB														
20.5-25	CRB	6DA921	L-5	186A2	20	17.00 / 2.0	61.9	21.2	22.2	28.1	341	89	20,900 @ 65	692
23.5-25	CRB	6DA923	L-5	191A2	20	19.50 / 2.5	67.0	24.1	25.9	29.9	427	95	24,000 @ 54	883
26.5-25	CRB	6DAT27	L-5	202A2	26	22.00 / 3.0	71.7	27.8	29.7	32.0	533	105	33,100 @ 65	1,293
29.5-25	CRB	6DAUW1	L-5	207A2	28	25.00 / 3.5	75.3	29.7	31.8	33.4	634	128	38,600 @ 62	1,586
Belted 7x7														
35/65-33	Belted 7x7	6DBC6B	L-5	222A2	42	28.00 / 3.5	82.3	34.7	35.7	37.7	653	115	58,400 @ 91	2,617
40/65-39	Belted 7x7	6DBV6C	L-5	223A2	30	32.00 / 4.0	94.3	39.1	40.6	42.6	936	128	60,000 @ 54	3,446
41.25/70-39	Belted 7x7	6DBC6D	L-5	234A2	42	32.00 / 4.5	99.3	42.0	43.9	44.8	1,106	140	82,500 @ 69	4,379
45/65-45	Belted 7x7	6DBJ7E	L-5	244A2	58	36.00 / 4.5	108.5	44.2	45.6	49.3	1,212	140	110,000 @ 98	5,712



TITAN LD 250 HAF-TRAC (L-5/L-5S)

- Extra deep tread depth provides long tread life in extreme conditions
- Smooth tread used on the outside provides excellent rock-type damage resistance, while the pattern on the inside provides increased traction
- Belted 7x7 - Features 7x7 steel belted construction, which provides increased cut resistance and extended wear



Tire Size	Compound/Construction	Catalog #	Industry Code	Load/Speed Index	Load Rating	Recom'd Rim Code	Outside Diameter (in)	Overall Width (in)	Static Loaded Width (in)	Static Loaded Radius (in)	Flat Plate Area (in ²)	Tread Depth (32 nd in)	Rated Load @ Inflation (lbs @ psi)	Weight (lbs)
35/65-33	Belted 7x7	6HBC6B	L-5/L-5S	222A2	42	28.00 / 3.5	82.3	34.7	35.7	37.7	653	115	58,400 @ 91	2,739



INCREASED
PUNCTURE
RESISTANCE



REDUCED
DOWNTIME



IMPROVED
TREAD WEAR



INCREASED
STABILITY

TITAN LD 250 SUPER SMOOTH (L-5S)

Key Benefits

- Extra deep tread depth provides long tread life in extreme conditions
- Smooth tread design provides the maximum rock-type damage resistance
- CRB – Features Aralon[®]* Cut Resistant Breaker construction, which provides increased strength and durability without sacrificing heat resistance
- CAB - Features Cushion Armor Breaker steel belted construction, which provides increased cut resistance
- Belted 7x7 - Features 7x7 steel belted construction, which provides increased cut resistance and extended wear



EXTREME LOADER APPLICATIONS
WHERE CUT PROTECTION IS TOP PRIORITY

MORE TREAD CONTACT = LONGER LIFE

USED IN: STEEL MILLS AND OPEN PIT MINES

Application(s)



	Tire Size	Compound/ Construction	Catalog #	Industry Code	Load/ Speed Index	Load Rating	Recom'd Rim Code	Outside Diameter (in)	Overall Width (in)	Static Loaded Width (in)	Static Loaded Radius (in)	Flat Plate Area (in ²)	Tread Depth (32 nd in)	Rated Load @ Inflation (lbs @ psi)	Weight (lbs)
CRB	23.5-25	CRB	6WAR23	L-5S	196A2	24	19.50 / 2.5	67.1	24.2	25.9	29.9	433	95	27,600 @ 69	1,065
	26.5-25	CRB	6WAW27	L-5S	206A2	32	22.00 / 3.0	71.8	28.0	29.5	32.1	527	105	37,500 @ 80	1,599
CAB	29.5-25	CAB	6WAXW1	L-5S	212A2	34	25.00 / 3.5	75.5	29.9	31.8	33.4	639	128	44,100 @ 76	2,011
Belted 7x7	35/65-33	Belted 7x7	6SBC6B	L-5S	222A2	42	28.00 / 3.5	82.3	34.7	35.7	37.7	653	115	58,400 @ 91	2,913
	41.25/70-39	Belted 7x7	6SBC6D	L-5S	234A2	42	32.00 / 4.5	99.3	42.0	43.9	44.8	1,106	140	82,500 @ 69	4,815
	45/65-45	Belted 7x7	6SBJ7E	L-5S	244A2	58	36.00 / 4.5	108.5	44.2	45.6	49.3	1,212	140	110,000 @ 98	6,349





TITAN LCM (L-3)

- Compact tread design provides excellent tread wear
- Directional tread design provides excellent traction
- "Value Engineered" VE-610 tread designed for long wear on concrete and asphalt



Tire Size	Compound/Construction	Catalog #	Industry Code	Load/Speed Index	Load Rating	Recom'd Rim Code	Outside Diameter (in)	Overall Width (in)	Static Loaded Width (in)	Static Loaded Radius (in)	Flat Plate Area (in ²)	Tread Depth (32 nd in)	Rated Load @ Inflation (lbs @ psi)	Weight (lbs)
21.00-25	VE-610	6C1B22	L-3	213A2	40	15.00 / 3.0	70.7	23.6	25.4	31.1	513	43	45,400 @ 120	928



TITAN CM 100 (E-3/L-3)

- Rock service tread designed for the challenges of large equipment demands
- Solid centerline tread pattern provides excellent cut resistance, smooth ride and extended wear
- CRB – Features Aralon[®]* Cut Resistant Breaker construction, which provides increased strength and durability without sacrificing heat resistance



Tire Size	Compound/Construction	Catalog #	Industry Code	Load/Speed Index	Load Rating	Recom'd Rim Code	Outside Diameter (in)	Overall Width (in)	Static Loaded Width (in)	Static Loaded Radius (in)	Flat Plate Area (in ²)	Tread Depth (32 nd in)	Rated Load @ Inflation (lbs @ psi)	Weight (lbs)
37.5-39	CRB	6M2NW9	E-3	225B	60	32.00 / 4.5	98.6	38.2	40.0	44.5	842	66	64,000 @ 80	2,734
			L-3	241A2			98.7	38.3	40.9	43.5	1,019		102,000 @ 109	





TITAN ND LCM (E-3/L-3), (IND-3), or (L-3)

- Non-directional tread design with center riding rib provides excellent all-around traction and lateral stability
- Rock service tread design provides resistance to rock damage and long tread life
- CRB – Features Aralon®* Cut Resistant Breaker construction, which provides increased strength and durability without sacrificing heat resistance



Tire Size	Compound/ Construction	Catalog #	Industry Code	Load/ Speed Index	Load Rating	Recom'd Rim Code	Outside Diameter (in)	Overall Width (in)	Static Loaded Width (in)	Static Loaded Radius (in)	Flat Plate Area (in ²)	Tread Depth (32 nd in)	Rated Load @ Inflation (lbs @ psi)	Weight (lbs)
16.00-25	--	6N3W65	L-3	196A2	32	11.25 / 2.0	59.3	17.5	19.2	26.6	258	35	27,600 @ 127	499
20.5-25	--	6NNR21	E-3	174B	24	17.00 / 2.0	58.0	21.2	22.3	26.3	254	35	14,800 @ 58	466
			L-3	189A2			58.3	21.4	22.7	25.9				
23.5-25	--	6NN923	E-3	177B	20	19.50 / 2.5	63.3	24.5	26.0	28.0	403	39	16,100 @ 44	527
			L-3	191A2			63.4	24.7	26.4	27.3				
23.5-25	--	6NNR23	E-3	180B	24	19.50 / 2.5	62.7	24.2	25.3	27.8	409	39	17,600 @ 51	585
			L-3	196A2			63.4	24.6	26.2	27.4				
26.5-25	--	6NNW27	E-3	191B	32	22.00 / 3.0	69.0	27.9	28.7	31.2	346	43	24,000 @ 58	911
			L-3	206A2			69.0	28.1	29.2	30.5				
26.5-25	--	6NND27	E-3	198B	44	22.00 / 3.0	68.6	27.2	27.6	31.5	325	43	29,100 @ 83	1,003
			L-3	213A2			68.7	27.2	28.0	30.8				
29.5-25	--	6NNUW1	E-3	193B	28	25.00 / 3.5	74.5	30.1	31.5	32.9	504	47	25,400 @ 47	1,014
			L-3	207A2			74.7	30.2	32.1	32.2				
29.5-25	--	6NNXW1	E-3	198B	34	25.00 / 3.5	74.6	30.2	31.6	32.9	495	47	29,100 @ 58	1,090
			L-3	212A2			74.8	30.4	32.1	32.2				
29.5-29	--	6NNXW2	E-3	200B	34	25.00 / 3.5	78.3	30.2	31.8	34.8	563	47	30,900 @ 58	1,136
			L-3	214A2			78.5	30.4	32.3	34.0				
33.25-35	CRB	6NNKW5	E-3	217B	56	27.00 / 3.5	89.2	33.3	34.7	40.2	570	53	50,700 @ 87	1,939
			L-3	232A2			89.8	33.5	35.3	39.4				
33.5-33	CRB	NN3GW6	IND-3	230A2	50	28.00 / 4.0	88.5	34.7	N/A	N/A	N/A	53	74,000 @ 98	1,926
37.5-33	CRB	6NNMW8	E-3	221B	54	32.00 / 4.5	93.7	38.3	39.0	42.2	718	58	56,800 @ 73	2,399
			L-3	235A2			93.7	38.3	39.0	42.2				



TITAN CH 150 (E-4/L-4)

- Deep, non-directional tread provides excellent rock-type damage and long tread life
- Solid centerline tread pattern provides smooth ride and excellent lateral traction



Tire Size	Catalog #	Industry Code	Load/ Speed Index	Load Rating	Recom'd Rim Code	Outside Diameter (in)	Overall Width (in)	Static Loaded Width (in)	Static Loaded Radius (in)	Flat Plate Area (in ²)	Tread Depth (32 nd in)	Rated Load @ Inflation (lbs @ psi)	Weight (lbs)
18.00-25	6HLB18	E-4	187B	40	13.00 / 2.5	65.0	20.3	21.2	30.4	281	66	21,500 @ 102	856
		L-4	206A2			65.1	20.4	21.7	29.7				

TITAN SM 150 (IND-4)

Key Benefits

- Deep tread, solid center and large contact area provide damage resistance and long tread life
- Self-cleaning grooves provide excellent traction
- CRB - Features Aralon** Cut Resistant Breaker construction, which provides increased strength and durability without sacrificing heat resistance
- VE-420 (Valued Engineered) tread designed for excellent chip and cut resistance from shot rock



Application(s)



“THE TIRE” FOR INDUSTRIAL SERVICE

HEAVY SIDE WALL FOR INCREASED STABILITY

USED IN: STEEL MILLS, POT/SLAB CARRIERS, LARGER CRANES

Tire Size	Compound/Construction	Catalog #	Industry Code	Load/Speed Index	Load Rating	Recom'd Rim Code	Outside Diameter (in)	Overall Width (in)	Static Loaded Width (in)	Static Loaded Radius (in)	Flat Plate Area (in ²)	Tread Depth (32 nd in)	Rated Load @ Inflation (lbs @ psi)	Weight (lbs)
40.00-57	VE-420,CRB	6SG473	IND-4	268A2	78	29.00 / 6.0	141.7	44.5	48.8	62.2	1,976	105	220,500 @ 120	7,709





TITAN CM 150 (E-4/L-4) or (IND-4)

- Deep, non-directional tread provides excellent rock-type damage resistance and long tread life
- Solid centerline tread pattern provides smooth ride and excellent lateral traction on high tonnage vehicles
- CRB – Features Aralon®* Cut Resistant Breaker construction, which provides increased strength and durability without sacrificing heat resistance



Tire Size	Compound/Construction	Catalog #	Industry Code	Load/Speed Index	Load Rating	Recom'd Rim Code	Outside Diameter (in)	Overall Width (in)	Static Loaded Width (in)	Static Loaded Radius (in)	Flat Plate Area (in ²)	Tread Depth (32 nd in)	Rated Load @ Inflation (lbs @ psi)	Weight (lbs)
18.00-33	--	6M5B83	E-4	193B	40	13.00 / 2.5	74.3	20.1	21.4	34.9	331	71	25,400 @ 102	1,087
			L-4	212A2			74.5	20.2	22.4	34.2	428		44,100 @ 138	
33.25-35	CRB	6MLKW5	E-4	217B	56	27.00 / 3.5	90.3	34.4	N/A	N/A	N/A	78	50,700 @ 87	2,530
			L-4	232A2			N/A	N/A	N/A	N/A	N/A		78,500 @ 112	
37.25-35	CRB	NM4FW7	IND-4	233A2	48	31.00 / 4.0	95.9	37.4	N/A	N/A	N/A	87	80,500 @ 87	2,737



TITAN QUARRY SPECIAL (E-4/L-4)

- "Value Engineered" VE-420 tread designed for excellent chip and cut resistance from shot rock
- Tread designed for traction with deep lugs and center riding rib for a smoother ride
- CRB – Features Aralon®* Cut Resistant Breaker construction, which provides increased strength and durability without sacrificing heat resistance



Tire Size	Compound/Construction	Catalog #	Industry Code	Load/Speed Index	Load Rating	Recom'd Rim Code	Outside Diameter (in)	Overall Width (in)	Static Loaded Width (in)	Static Loaded Radius (in)	Flat Plate Area (in ²)	Tread Depth (32 nd in)	Rated Load @ Inflation (lbs @ psi)	Weight (lbs)
21.00-35	VE-420, CRB	6QSC25	E-4	201B	42	15.00 / 3.0	82.2	23.7	24.7	37.2	475	71	32,000 @ 94	1,448
			L-4	219A2			82.3	23.1	25.1	35.5	624		53,600 @ 123	
24.00-35	VE-420, CRB	6QSF43	E-4	209B	48	17.00 / 3.5	81.1	23.6	27.8	39.6	428	70	40,800 @ 94	1,717
			L-4	228A2			N/A	N/A	N/A	N/A	N/A		69,500 @ 127	
24.00-49	VE-420, CRB	6QSF49	E-4	215B	48	17.00 / 3.5	100.8	26.5	28.0	46.9	532	70	48,100 @ 94	2,178
			L-4	222A2			100.9	26.9	29.0	45.8	718		85,500 @ 127	
27.00-49	VE-420, CRB	6QSF79	E-4	220B	48	19.50 / 4.0	105.8	30.8	32.9	48.9	684	78	55,100 @ 83	2,627
			L-4	239A2			106.1	31.0	34.0	47.6	901		96,500 @ 112	
30.00-51	VE-420, CRB	6QSH30	E-4	226B	52	22.00 / 4.5	114.4	32.5	34.8	52.7	816	85	66,000 @ 80	3,699
			L-4	246A2			114.4	32.5	34.8	52.7	816		117,000 @ 109	
33.00-51	VE-420, CRB	6Q4J35	E-4	232B	58	24.00 / 5.0	119.1	35.9	38.2	54.7	1,053	98	78,500 @ 83	4,280
			L-4	252A2			N/A	N/A	N/A	N/A	N/A		139,000 @ 112	
36.00-51	VE-420, CRB	6QSJ36	E-4	237B	58	26.00 / 5.0	127.9	40.0	42.3	58.9	1,202	100	91,000 @ 76	5,641
			L-4	256A2			128.1	40.0	44.1	56.2	1,536		156,500 @ 98	



TITAN ND SUPER LCM (E-4/L-4)

- Non-directional tread design with center riding rib provides excellent all-around traction and lateral stability
- Increased tread depth provides extended tread life and exceptional resistance to rock-type damage



Tire Size	Catalog #	Industry Code	Load/Speed Index	Load Rating	Recom'd Rim Code	Outside Diameter (in)	Overall Width (in)	Static Loaded Width (in)	Static Loaded Radius (in)	Flat Plate Area (in ²)	Tread Depth (32 nd in)	Rated Load @ Inflation (lbs @ psi)	Weight (lbs)
18.00-25	6UNB18	E-4	187B	40	13.00 / 2.5	65.4	20.1	21.0	30.2	242	66	21,500 @ 102	785
		L-4	206A2			65.4	20.2	21.7	29.4	327		37,500 @ 138	



TITAN SUPER SMOOTH (L-4S)

- Deep tread depth provides extended tread life
- Smooth tread design provides maximum damage resistance
- "Value Engineered" VE-610 tread designed for long wear on concrete and asphalt



Tire Size	Compound/Construction	Catalog #	Industry Code	Load/Speed Index	Load Rating	Recom'd Rim Code	Outside Diameter (in)	Overall Width (in)	Static Loaded Width (in)	Static Loaded Radius (in)	Flat Plate Area (in ²)	Tread Depth (32 nd in)	Rated Load @ Inflation (lbs @ psi)	Weight (lbs)
18.00-25	VE-610	646B18	L-4S	206A2	40	13.00 / 2.5	65.6	20.4	21.6	30.1	302	66	37,500 @ 138	950
18.00-33	VE-610	646B83	L-4S	212A2	40	13.00 / 2.5	74.1	20.6	21.9	34.3	357	66	44,100 @ 138	1,163





TITAN LD 250 SUPER SMOOTH UGM (L-5S)

- Extra deep tread depth provides long tread life in extreme conditions
- Smooth tread design provides the maximum rock-type damage resistance
- UGM – Special tread designed specifically to handle the harsh conditions of underground mining
- CRB – Features Aralon™* Cut Resistant Breaker construction, which provides increased strength and durability without sacrificing heat resistance
- CAB - Features Cushion Armor Breaker steel belted construction, which provides increased cut resistance
- Belted 7x7 - Features 7x7 steel belted construction, which provides increased cut resistance and extended wear



Tire Size	Compound/Construction	Catalog #	Industry Code	Load/Speed Index	Load Rating	Recom'd Rim Code	Outside Diameter (in)	Overall Width (in)	Static Loaded Width (in)	Static Loaded Radius (in)	Flat Plate Area (in ²)	Tread Depth (32 nd in)	Rated Load @ Inflation (lbs @ psi)	Weight (lbs)
12.00-24NHS	UGM	SBT912	L-5S	175A2	20	8.50	48.3	12.5	14.0	21.8	N/A	77	15,200 @ 120	341
18.00-25	UGM, CRB	UGMW18	L-5S	202A2	32	13.00 / 2.5	65.6	20.4	21.6	30.1	302	99	33,100 @ 109	1,041
26.5-25	UGM, CRB	6SUW27	L-5S	206A2	32	22.00 / 3.0	71.8	28.0	29.5	32.1	527	105	37,500 @ 80	1,609
29.5-25	UGM, CAB	6CUXW1	L-5S	212A2	34	25.00 / 3.5	75.5	29.9	31.8	33.4	639	128	44,100 @ 76	2,011
29.5-29	UGM, CRB	6SUXW2	L-5S	214A2	34	25.00 / 3.5	79.2	29.8	31.6	35.4	672	115	46,700 @ 76	1,996
35/65-33	UGM, 7x7	67UC6B	L-5S	222A2	42	28.00 / 3.5	82.3	34.7	35.7	37.7	653	115	58,400 @ 91	2,867



GOODYEAR LOGGER LUG III HD (LS-2)

Key Benefits

- Twice as much steel armor construction as standard Logger Lug III for excellent penetration resistance
- Special forestry compound for increased resistance to tread chunking and tearing
- Improved lug stability and wear



Application(s)



TREAD AND SIDEWALL COMPOUNDS DEVELOPED FOR FORESTRY

WIDER STEEL BELTS OFFER INCREASED PROTECTION VS THE COMPETITION



Tire Size	Compound/Construction	Catalog #	TT/TL	Industry Code	Load/Speed Index	Load Rating	Recom'd Rim Code	Outside Diameter (in)	Overall Width (in)	Static Loaded Width (in)	Static Loaded Radius (in)	Flat Plate Area (in ²)	Tread Depth (32 nd in)	Rated Load @ Inflation (lbs @ psi)	Weight (lbs)
28L-26	HD	YL7998	TL	LS-2	165A6	20	DW25B	65.2	27.8	28.5	29.7	401	74	11,400 @ 35	743
					177A2			N/A	N/A	N/A	N/A	16,100 @ 40			
30.5L-32	HD	YL7T96	TL	LS-2	176A6	26	DH27	74.1	30.0	30.8	34.0	415	70	15,700 @ 40	1,014
					188A2			74.1	30.1	31.2	33.3	511		22,000 @ 45	
30.5L-32	HD	YL7W96	TL	LS-2	180A6	32	DH27	73.9	30.6	31.3	34.7	484	70	17,600 @ 50	1,041
					192A2			74.0	30.9	32.4	33.2	580		24,700 @ 55	
DH35.5L-32	HD	YL7TD5	TL	LS-2	183A6	26	DH31	78.9	35.7	36.6	36.6	576	75	19,300 @ 35	1,388
					195A2			78.8	35.8	37.4	35.4	685		26,800 @ 40	
DH35.5L-32	HD	YL7VD5	TL	LS-2	186A6	30	DH31	78.7	36.5	37.1	36.5	611	75	20,900 @ 40	1,434
					198A2			78.7	36.3	38.3	35.7	745		29,100 @ 45	





GOODYEAR LOGGER LUG III (LS-2)

- Optimal lug angle provides optimized balance between traction and cut resistance
- Special forestry compound for increased resistance to tread chunking and tearing
- Steel belt construction provides excellent penetration resistance



Tire Size	Catalog #	TL/TT	Industry Code	Load/Speed Index	Load Rating	Recom'd Rim Code	Outside Diameter (in)	Overall Width (in)	Static Loaded Width (in)	Static Loaded Radius (in)	Flat Plate Area (in ²)	Tread Depth (32 nd in)	Rated Load @ Inflation (lbs @ psi)	Weight (lbs)
23.1-26	YL3586	TL	LS-2	160A6	16	DW20B	63.8	24.2	25.4	29.5	302	72	9,900 @ 35	640
				172A2			63.8	24.2	26.1	28.7	N/A	13,900 @ 40		
24.5-32	YL3999	TL	LS-2	170A6	20	DH21	70.4	24.5	25.5	32.8	398	64	13,200 @ 40	777
				182A2			70.5	24.3	25.8	32.3	510	18,700 @ 45		



GOODYEAR LOGGER LUG III FLOTATION (HF-3+) or (HF-4)

- Extra-wide tread for high flotation in wet terrain while providing low ground penetration to minimize environmental impact
- Special forestry compound for increased resistance to tread chunking and tearing
- Four steel belted construction provides excellent penetration resistance



Tire Size	Catalog #	TT/TL	Industry Code	Load/Speed Index	Load Rating	Recom'd Rim Code	Outside Diameter (in)	Overall Width (in)	Static Loaded Width (in)	Static Loaded Radius (in)	Flat Plate Area (in ²)	Tread Depth (32 nd in)	Rated Load @ Inflation (lbs @ psi)	Weight (lbs)
66x43.00-25NHS	YL39F3	TL	HF-4	174B	20	36.0TH	69.4	41.2	41.5	32.9	N/A	112	14,800 @ 50	1,482
				190A2			69.4	41.2	41.5	32.9	N/A	23,400 @ 50		
66x43.00-26NHS	YL39F6	TL	HF-4	174B	20	DW36B	69.4	41.2	41.5	32.9	N/A	112	14,800 @ 50	1,475
				190A2			69.4	41.2	41.5	32.9	N/A	23,400 @ 50		
67x34.00-25NHS	YL33R3	TL	HF-4	170B	14	30.0TH	69.2	34.3	34.7	32.4	420	118	13,200 @ 40	1,361
				186A2			69.2	34.3	35.2	31.4	580	20,900 @ 40		
67x34.00-26NHS	YL3R65	TL	HF-4	170B	14	DW30B	69.2	34.3	34.7	32.4	420	118	13,200 @ 40	1,361
				186A2			69.2	34.3	35.2	31.4	580	20,900 @ 40		
DH73x44.00-32	YL39R6	TL	HF-3+	180B	20	DH36HB	74.6	41.2	41.4	35.6	516	104	17,600 @ 50	1,618
				196A2			74.6	41.2	41.9	35.0	682	27,600 @ 50		
DH73x50.00-32	YL39V6	TL	HF-3+	179B	20	DH44HB	74.4	49.1	49.2	36.8	647	104	17,100 @ 45	1,931
				195A2			74.4	49.1	N/A	N/A	N/A	26,800 @ 45		



TITAN ROAD ROLLER II (C-1)

- Constructed of superior heat resistant nylon fabric plies to promote heat dissipation
- Designed for maximum life, this tire is frequently the tire of choice for industrial compactor applications



Tire Size	Catalog #	Industry Code	Load Rating	Recom'd Rim Code	Outside Diameter (in)	Overall Width (in)	Static Loaded Width (in)	Static Loaded Radius (in)	Flat Plate Area (in ²)	Tread Depth (32 nd in)	Rated Load @ Inflation (lbs @ psi)	Weight (lbs)
7.50-15NHS	3GR2E1F	C-1	14	6.00	30.8	8.1	N/A	14.1	N/A	0	6,300 @ 125	58
8.5/90-15K	3GR3A2	C-1	6	5.50F	30.9	8.1	N/A	13.7	N/A	0	3,900 @ 50	54

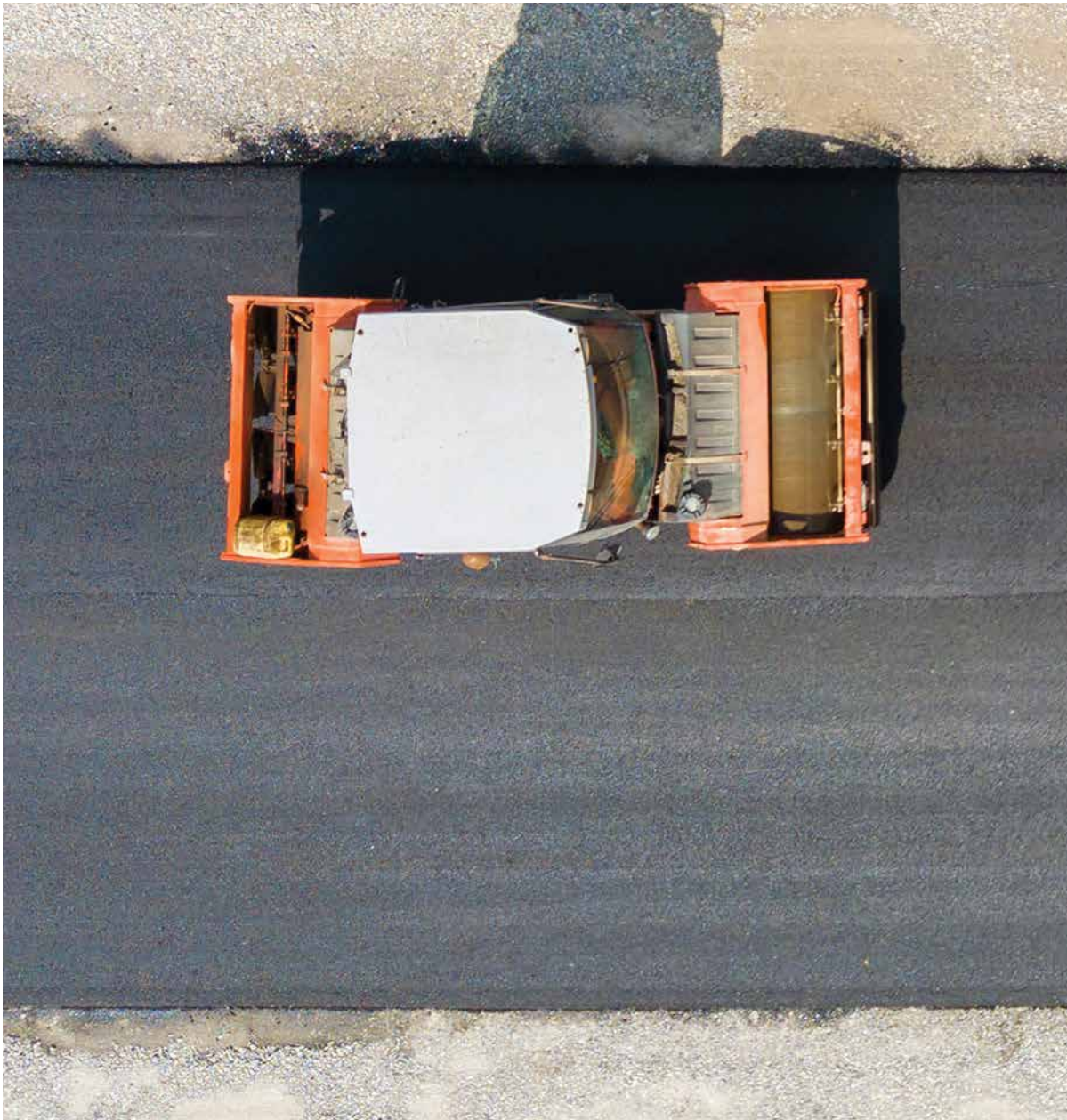



TITAN INDUSTRIAL TRACTOR LUG (R-4)

- Extra-wide lugs with extensive overlap at the center, designed to resist buckling, tearing and cracking
- Excellent tread wear and roadability, the laterally designed lugs result in even wear



Tire Size	Catalog #	TL/TT	Ply Rating	Inflation Pressure (psi)	Rated Load (lbs)	Approved Rim	Overall Width (in)	Outside Diameter (in)	Static Loaded Radius (in)	Rolling Circ. (in)	Tread Depth (32 nd in)	RCI	SRI
14.9-24	486834	TL	8	30	5,080	DW11, W12 , DW12, W13, DW13, DW13L	15.2	48.9	22.1	144	34	38	600
420/70-24	4866T2	TL	6	20	3,960	W13, W15L	17.0	47.7	21.5	141	35	--	575
16.9-24	486845	TL	8	28	5,840	DW14L, W15L , DW15L	17.8	51.5	23.2	152	35	--	625
16.9-24	486145	TL	12	38	7,150	DW14L, W15L , DW15L	17.4	50.6	23.0	153	35	--	625
17.5L-24	486803	TL	8	26	5,360	DW14L, W15L , DW15L	17.7	49.4	22.0	144	32	38	600
17.5L-24	486103	TL	12	36	6,600	DW14L, W15L , DW15L	17.6	49.2	23.5	150	32	38	600
18.4-24	486864	TL	8	24	6,400	W15L, W16A , W16L	19.3	54.4	24.3	159	35	40	650
18.4-26	486156	TL	12	36	8,800	W15L, DW15A, DW15L, DW16A , DW16L	19.2	56.1	25.3	165	35	41	675
18.4-28	486058	TL	10	30	7,850	W15L, DW15L, W16L, DW16A , DW16L	18.8	57.8	26.4	172	35	--	700
19.5L-24	486861	TL	8	24	6,000	W15L, W16L, DW16A , DW16L	19.6	52.8	23.6	155	34	--	625
19.5L-24	486161	TL	12	34	7,600	DW16A , DW16L	19.3	51.9	23.3	153	34	--	625
21L-24	486175	TL	12	32	8,550	DW18A , DW18L	21.4	54.0	24.1	158	35	40	650



GOODYEAR IT520 (R-4)

- Outstanding soft soil traction
- Reinforced lugs for deeper grip and extended wear
- Industrial use applications



Tire Size	Catalog #	TL/TT	Load Rating	Inflation Pressure (psi)	Rated Load (lbs)	Approved Rim	Overall Width (in)	Outside Diameter (in)	Static Loaded Radius (in)	Rolling Circ. (in)	Tread Depth (32 nd in)	RCI	SRI
460/70R24IND	4528A4	TL	159A8/B	58	9,650	W14L, DW14L, W15L , DW15L, DW16L	18.1	49.4	22.2	145	42	--	600

GOODYEAR IT525 (R-4)



Key Benefits

- Solid performance on rock-hard ground
- Increased wear and performance on hard surfaces
- Excellent traction in soft soils



Application(s)



Tire Size	Catalog #	TL/TT	Ply Rating	Inflation Pressure (psi)	Rated Load (lbs)	Approved Rim	Overall Width (in)	Outside Diameter (in)	Static Loaded Radius (in)	Rolling Circ. (in)	Tread Depth (32 nd in)	RCI	SRI
16.9-24	45T145	TL	12	38	7,150	DW14L, W15L , DW15L	16.9	51.0	23.0	151	33	39	625
16.9-28	45T148	TL	12	38	7,600	DW14L, W15L , DW15L	16.8	55.3	25.0	163	33	41	675
18.4-24	45T164	TL	12	36	8,250	W15L, W16A , W16L	18.4	54.1	24.2	160	34	40	650
19.5L-24	45T161	TL	12	34	7,600	DW16A , DW16L	20.1	52.5	23.8	155	34	--	625
21L-24	45T175	TL	12	32	8,550	DW18A , DW18L	21.5	53.9	24.0	158	34	40	650
21L-24	45T575	TL	16	40	9,900	DW18A , DW18L	20.8	54.2	24.3	160	34	40	650
21L-28	45T376	TL	14	36	9,900	DW18A	20.9	57.1	26.1	170	34	--	700





GOODYEAR IT530 (R-4)

- Excellent hard soil traction
- High puncture resistance
- Refined road comfort



Tire Size	Catalog #	TL/TT	Load Rating	Inflation Pressure (psi)	Rated Load (lbs)	Approved Rim	Overall Width (in)	Outside Diameter (in)	Static Loaded Radius (in)	Rolling Circ. (in)	Tread Depth (32 nd in)	RCI	SRI
500/70R24	453661	TL	157A8/B	46	9,100	W15L, DW15L, W16L, DW16A , DW16L, DW18L	19.5	51.2	22.8	154	34	--	625



TITAN CONTRACTOR (F-3)

- Low section design for loader backhoe applications
- Designed for excellent durability and good road handling characteristics



Tire Size	Catalog #	TL/TT	Ply Rating	Load Rating	Inflation Pressure (psi)	Rated Load (lbs)	Approved Rim	Overall Width (in)	Outside Diameter (in)	Static Loaded Radius (in)	Rolling Circ. (in)	Tread Depth (32 nd in)	RCI	SRI
11L-16SL	465317	TL	12	N/A	64	2,760	W8L, 8LB , W10L, 10LB	10.9	32.4	15.1	97	15	--	--
14.5/75-16.1SL	465388	TL	10	N/A	40	3,200	W11C	13.7	35.5	16.4	105	18	--	--
480/45-17	4652Q3	TL	N/A	134A8/B	29	4,680	16.00	18.8	33.9	14.9	98	15	--	--





GOODYEAR LABORER (F-3)

- Industrial use for rugged applications
- Resists tearing and cracking with special tread compound
- Excellent handling and mobility with its five-rib design



Tire Size	Catalog #	TL/TT	Ply Rating	Inflation Pressure (psi)	Rated Load (lbs)	Approved Rim	Overall Width (in)	Outside Diameter (in)	Static Loaded Radius (in)	Rolling Circ. (in)	Tread Depth (32 nd in)	RCI	SRI
11L-15SL	4LT310	TL	10	52	2,340	8LB, 10LB	10.9	30.8	14.2	92	12	--	--
11L-16SL	4LT317	TL	12	64	2,760	W8L, 8LB, W10L, 10LB	10.9	31.6	14.7	95	16	--	--



TITAN CONTRACTOR II (I-3)

- More robust design for use on the front of large backhoes



Tire Size	Catalog #	TL/TT	Ply Rating	Load Rating	Inflation Pressure (psi)	Rated Load (lbs)	Approved Rim	Overall Width (in)	Outside Diameter (in)	Static Loaded Radius (in)	Rolling Circ. (in)	Tread Depth (32 nd in)	RCI	SRI
12.5/80-18	42E3T7	TL	12	139A8	56	5,360	9, W9, 11	12.5	38.8	17.5	115	32	--	--



TITAN CONTRACTOR-T (I-3)

- An implement tire specially designed for high traction applications
- Frequently used on the front of backhoes



Tire Size	Catalog #	TL/TT	Ply Rating	Inflation Pressure (psi)	Rated Load (lbs)	Approved Rim	Overall Width (in)	Outside Diameter (in)	Static Loaded Radius (in)	Rolling Circ. (in)	Tread Depth (32 nd in)	RCI	SRI
10.5/80-18	46W3J8	TL	10	54	3,840	W8, 9, W9	10.9	35.9	16.7	108	29	--	--
12.5/80-18	46W3J9	TL	10	46	4,710	9, W9, 11	12.1	38.3	18.0	116	31	--	--





GOODYEAR SURE GRIP LUG (I-3)

- Good choice for industrial equipment
- Directional design for excellent traction and long wear
- For use in soft soil operations where traction and flotation are required



Tire Size	Catalog #	TL/TT	Ply Rating	Inflation Pressure (psi)	Rated Load (lbs)	Approved Rim	Overall Width (in)	Outside Diameter (in)	Static Loaded Radius (in)	Rolling Circ. (in)	Tread Depth (32 nd in)	RCI	SRI
12.5/80-18	4GL5J9	TL	14	62	6,600	9, W9, 11	12.0	39.7	17.7	116	31	--	--



TITAN TI422 (I-3)

- Designed for low horsepower traction requirements, the TI422 offers good roadability and excellent durability



Tire Size	Catalog #	TL/TT	Ply Rating	Inflation Pressure (psi)	Rated Load (lbs)	Approved Rim	Overall Width (in)	Outside Diameter (in)	Static Loaded Radius (in)	Rolling Circ. (in)	Tread Depth (32 nd in)	RCI	SRI
12.5/80-18NHS	4223J9	TL	10	46	4,680	9, W9, 11	12.3	39.3	17.8	116	34	--	--





TITAN CONTRACTOR FWD (SS)

- Excellent traction and wear are the benefits of the broad, curved lugs
- High strength construction gives it exceptional durability



Tire Size	Catalog #	TL/TT	Ply Rating	Inflation Pressure (psi)	Rated Load (lbs)	Approved Rim	Overall Width (in)	Outside Diameter (in)	Static Loaded Radius (in)	Rolling Circ. (in)	Tread Depth (32 nd in)	RCI	SRI
12-16.5NHS	46C3E6	TL	6	40	4,220	9.75	11.7	33.2	14.8	97	23	--	--



TITAN HD 2000 (SS)

- Engineered with HD sidewalls to protect against abrasions, tears and punctures
- Improved dual tapered step lug for wear and extended life



Tire Size	Catalog #	TL/TT	Ply Rating	Inflation Pressure (psi)	Rated Load (lbs)	Approved Rim	Overall Width (in)	Outside Diameter (in)	Static Loaded Radius (in)	Rolling Circ. (in)	Tread Depth (32 nd in)	RCI	SRI
10-16.5NHS	4393D1	TL	8	60	4,140	8.25	10.7	30.9	14.1	92	21	--	--
15-19.5NHS	439336	TL	12	60	9,190	11.75, 12.25	15.8	40.0	18.0	118	25	--	--



TITAN HD 2000 II (SS)

- Titan's premium conventional skid steer tire with deeper tread depth, premium compound, larger tread lugs, heavier sidewall and larger rim guard



Tire Size	Catalog #	TL/TT	Ply Rating	Inflation Pressure (psi)	Rated Load (lbs)	Approved Rim	Overall Width (in)	Outside Diameter (in)	Static Loaded Radius (in)	Rolling Circ. (in)	Tread Depth (32 nd in)	RCI	SRI
10-16.5NHS	49E3D1	TL	8	60	4,140	8.25	11.0	30.4	13.9	90	24	--	--
12-16.5NHS	49E3J7	TL	10	65	5,600	9.75	13.0	32.7	15.0	98	26	--	--
14-17.5NHS	49E384	TL	14	80	8,540	10.50	15.2	35.8	16.2	106	26	--	--
31x15.50-16.5	49E3L8	TL	8	40	4,850	12.00	14.8	30.5	13.6	89	24	--	--
33x15.50-16.5	49E3R9	TL	14	70	7,480	12.00	15.1	33.2	14.9	98	26	--	--





TITAN H/E (SS)

- Titan's premium deep tread skid steer tire, designed for use in severe applications such as concrete, asphalt, demolition areas, quarries, glass plants, and scrap yards



Tire Size	Catalog #	TL/TT	Ply Rating	Inflation Pressure (psi)	Rated Load (lbs)	Approved Rim	Overall Width (in)	Outside Diameter (in)	Static Loaded Radius (in)	Rolling Circ. (in)	Tread Depth (32 nd in)	RCI	SRI
10-16.5NHS	43H3R8	TL	10	75	4,710	8.25	10.6	30.7	14.1	91	44	--	--
12-16.5NHS	43H34R	TL	14	90	6,780	9.75	12.5	33.3	15.6	100	44	--	--
14-17.5NHS	43H384	TL	14	80	8,540	10.50	13.7	35.9	16.0	105	47	--	--



TITAN LSW G9A (SS)

- Premium LSW skid steer tire with all the features of the HD 2000 II, plus run-flat capability
- LSW assemblies reduce bounce and lope, and improve lateral stability



Tire Size	Catalog #	TL/TT	Ply Rating	Inflation Pressure (psi)	Rated Load (lbs)	Approved Rim	Overall Width (in)	Outside Diameter (in)	Static Loaded Radius (in)	Rolling Circ. (in)	Tread Depth (32 nd in)	RCI	SRI
LSW305-546NHS	G9A3M1	TL	10	65	5,600	546x248LSW	11.9	32.8	15.0	97	24	--	--



TITAN TGS2 (SS)

- All-season tread pattern
- Aggressive tread pattern and siping provides excellent traction on all surfaces and conditions, especially snow, ice and mud



Tire Size	Catalog #	TL/TT	Tread Design	Ply Rating	Inflation Pressure (psi)	Rated Load (lbs)	Approved Rim	Overall Width (in)	Outside Diameter (in)	Static Loaded Radius (in)	Rolling Circ. (in)	Tread Depth (32 nd in)	RCI	SRI
12-16.5NHS	4S23J7	A	TL	10	65	5,600	9.75	13.3	33.0	N/A	N/A	20	--	--



TITAN TRAC LOADER CHEVRON (SS)

- Features chevron tread pattern with nylon fabric construction
- Intended for skid steer use



Tire Size	Catalog #	TL/TT	Ply Rating	Inflation Pressure (psi)	Rated Load (lbs)	Approved Rim	Overall Width (in)	Outside Diameter (in)	Static Loaded Radius (in)	Rolling Circ. (in)	Tread Depth (32 nd in)	RCI	SRI
7.00-15SS	4123C5	TL	6	60	3,180	5.50F, 6LB	8.0	30.2	13.5	88	17	--	--



TITAN ULTIMATE (SS)

- Extra long life with up to twice the tread depth of conventional skid steer tires
- Superior damage resistance due to extra heavy sidewall and large rim guard
- Superior traction from high void-to-lug ratio
- Lowest possible cost per hour delivered by specialty compound and industry leading tread depth



Tire Size	Catalog #	TL/TT	Ply Rating	Inflation Pressure (psi)	Rated Load (lbs)	Approved Rim	Overall Width (in)	Outside Diameter (in)	Static Loaded Radius (in)	Rolling Circ. (in)	Tread Depth (32 nd in)	RCI	SRI
10-16.5NHS	49U3D1	TL	8	60	4,140	8.25	10.7	30.1	13.8	89	42	--	--
12-16.5NHS	49U3J7	TL	10	65	5,600	9.75	12.2	33.0	15.2	98	44	--	--
14-17.5NHS	49U384	TL	14	80	8,540	10.50	14.6	35.4	16.1	105	42	--	--





LOAD & INFLATION TABLES TABLE OF CONTENTS

Bias Articulated Dump Truck

17.5-25 Articulated Dump Truck Usage Chart.....	68
20.5-25 Articulated Dump Truck Usage Chart.....	68
23.5-25 Articulated Dump Truck Usage Chart.....	68
26.5-25 Articulated Dump Truck Usage Chart.....	70
29.5-25 Articulated Dump Truck Usage Chart.....	71

Bias Grader

13.00-24TG Grader Usage Chart.....	73
14.00-24TG Grader Usage Chart.....	73
16.00-24TG Grader Usage Chart.....	75
17.5-25 Grader Usage Chart.....	75

Bias Loader

15.5-25 Loader Usage Chart.....	77
17.5-25 Loader Usage Chart.....	77
20.5-25 Loader Usage Chart.....	80
Titan HK 458 20.5-25 Loader Usage Chart.....	83
23.5-25 Loader Usage Chart.....	86
Titan HK 458 23.5-25 Loader Usage Chart.....	88
26.5-25 Loader Usage Chart.....	90
29.5-25 Loader Usage Chart.....	92
725/70-25 Loader Usage Chart.....	93
35/65-33 Loader Usage Chart.....	93
40/65-39 Loader Usage Chart.....	95
45/65-45 Loader Usage Chart.....	95
41.25/70-39 Loader Usage Chart.....	95

Bias Rigid Dump Truck

18.00-25 Rigid Dump Truck Usage Chart.....	96
18.00-33 Rigid Dump Truck Usage Chart.....	96
21.00-35 Rigid Dump Truck Usage Chart.....	97
24.00-35 Rigid Dump Truck Usage Chart.....	97
24.00-49 Rigid Dump Truck Usage Chart.....	98
27.00-49 Rigid Dump Truck Usage Chart.....	98
30.00-51 Rigid Dump Truck Usage Chart.....	99
33.00-51 Rigid Dump Truck Usage Chart.....	100

Bias Towed Scraper

20.5-25 Towed Scraper Usage Chart.....	101
23.5-25 Towed Scraper Usage Chart.....	101
26.5-25 Towed Scraper Usage Chart.....	101
29.5-25 Towed Scraper Usage Chart.....	101

Bias Tractor Scraper

18.00-25 Tractor Scraper Usage Chart.....	102
23.5-25 Tractor Scraper Usage Chart.....	102
26.5-25 Tractor Scraper Usage Chart.....	102
29.5-25 Tractor Scraper Usage Chart.....	103
29.5-29 Tractor Scraper Usage Chart.....	103
29.5-35 Tractor Scraper Usage Chart.....	103
33.25-29 Tractor Scraper Usage Chart.....	104
33.25-35 Tractor Scraper Usage Chart.....	104
33.5-33 Tractor Scraper Usage Chart.....	104
37.5-33 Tractor Scraper Usage Chart.....	105
37.25-35 Tractor Scraper Usage Chart.....	105
37.5-39 Tractor Scraper Usage Chart.....	105

Radial Articulated Dump Truck

17.5R25 Articulated Dump Truck Usage Chart.....	106
20.5R25 Articulated Dump Truck Usage Chart.....	106
23.5R25 Articulated Dump Truck Usage Chart.....	107
26.5R25 Articulated Dump Truck Usage Chart.....	109
29.5R25 Articulated Dump Truck Usage Chart.....	110
750/65R25 Articulated Dump Truck Usage Chart.....	111
875/65R29 Articulated Dump Truck Usage Chart.....	112

Radial Grader

14.00R24TG Grader Usage Chart.....	113
17.5R25 Grader Usage Chart.....	114
20.5R25 Grader Usage Chart.....	116
29.5R29 Grader Usage Chart.....	116

Radial Loader

17.5R25 Loader Usage Chart.....	117
20.5R25 Loader Usage Chart.....	120
23.5R25 Loader Usage Chart.....	123
26.5R25 Loader Usage Chart.....	125
29.5R25 Loader Usage Chart.....	127
750/65R25 Loader Usage Chart.....	128
875/65R29 Loader Usage Chart.....	128
35/65R33 Loader Usage Chart.....	129
45/65R45 Loader Usage Chart.....	130
50/65R51 Loader Usage Chart.....	130
58/80R63 Loader Usage Chart.....	131

Radial Rigid Dump Truck

18.00R33 Rigid Dump Truck Usage Chart.....	132
24.00R35 Rigid Dump Truck Usage Chart.....	133
27.00R49 Rigid Dump Truck Usage Chart.....	134
33.00R51 Rigid Dump Truck Usage Chart.....	135
37.00R57 Rigid Dump Truck Usage Chart.....	135
40.00R57 Rigid Dump Truck Usage Chart.....	136
46/90R57 Rigid Dump Truck Usage Chart.....	136
50/80R57 Rigid Dump Truck Usage Chart.....	137
53/80R63 Rigid Dump Truck Usage Chart.....	137
56/80R63 Rigid Dump Truck Usage Chart.....	137
59/80R63 Rigid Dump Truck Usage Chart.....	138

Radial Towed Scraper

17.5R25 Towed Scraper Usage Chart.....	139
20.5R25 Towed Scraper Usage Chart.....	139
23.5R25 Towed Scraper Usage Chart.....	139
26.5R25 Towed Scraper Usage Chart.....	139
29.5R25 Towed Scraper Usage Chart.....	140
875/65R29 Towed Scraper Usage Chart.....	140

Radial Tractor Scraper

23.5R25 Towed Scraper Usage Chart.....	141
26.5R25 Towed Scraper Usage Chart.....	141
29.5R25 Towed Scraper Usage Chart.....	142

Industrial Vehicle

Off the Road Tire Loads - Use on Industrial Vehicles.....	143
Industrial Vehicle for use on Smooth Floors & Runways Only.....	143

Other Inflation Tables

Pavers.....	144
High Flotation Bias.....	146
High Flotation Radial.....	148
Forestry.....	149
Material Handling.....	151
Approved Rim Contours.....	153

BIAS ARTICULATED DUMP TRUCK

17.5-25 ARTICULATED DUMP TRUCK USAGE CHART

For Standard Earthmover Service: <2.5 mile, < 30 mph



Manufacturer	Model	Payload (tons)	Front Minimum Ply Rating	Front Minimum Inflation (psi)	Middle Minimum Ply Rating	Middle Minimum Inflation (psi)	Rear Minimum Ply Rating	Rear Minimum Inflation (psi)
Bell	B17B	17	CT	CT	CT	CT	CT	CT

20.5-25 ARTICULATED DUMP TRUCK USAGE CHART

For Standard Earthmover Service: <2.5 mile, < 30 mph



Manufacturer	Model	Payload (tons)	Front Minimum Ply Rating	Front Minimum Inflation (psi)	Middle Minimum Ply Rating	Middle Minimum Inflation (psi)	Rear Minimum Ply Rating	Rear Minimum Inflation (psi)
Bell	B18E	20	16	35	20	45	20	45
Bell	B20B	20	16	35	20	40	20	40
Bell	B20D 6x4	18	16	30	24	45	20	45
Bell	B20D 6x6	18	16	30	24	50	24	45
Bell	B20E	20	16	35	20	45	20	45
Caterpillar	D250B	25	24	50	CT	CT	CT	CT
Caterpillar	D250D	25	24	45	CT	CT	CT	CT
Komatsu	HA250-1	25	CT	CT	CT	CT	CT	CT
Moxy	MT30 LHS	30	CT	CT	CT	CT	CT	CT
Terex	2364	23	24	50	24	50	24	45
Terex	2366	23	24	50	24	50	24	45
Terex	2566B	25	CT	CT	CT	CT	24	50
Terex	2566C	25	CT	CT	CT	CT	24	55
Volvo	A20 6X4	20	-	-	20	45	20	45
Volvo	A20 6x6	20	-	-	20	45	20	45
Volvo	A20C 6X6	20	20	40	20	45	20	45
Volvo	A25 6X4	25	20	40	CT	CT	CT	CT
Volvo	A25	25	20	45	CT	CT	CT	CT
Volvo	A25B	25	20	40	CT	CT	CT	CT

Pressure and ply recommendations based on normal quarry operations with standard equipment. For different applications, or modified equipment, please contact OTR Field Engineering for a specific recommendation. Tire damage or failure caused by improper load, ply, speed or inflation practices is not covered by the Titan Tire Warranty Policy.

CT - Contact Titan Technical services

23.5-25 ARTICULATED DUMP TRUCK USAGE CHART

For Standard Earthmover Service: <2.5 mile, < 30 mph



Manufacturer	Model	Payload (tons)	Front Minimum Ply Rating	Front Minimum Inflation (psi)	Middle Minimum Ply Rating	Middle Minimum Inflation (psi)	Rear Minimum Ply Rating	Rear Minimum Inflation (psi)
Bell	B25B	25	20	35	20	35	20	35
Bell	B25D	26	20	35	20	40	20	40
Bell	B25E	27	16	30	CT	CT	CT	CT
Bell	B30B	30	CT	CT	CT	CT	CT	CT
Bell	B30D	30	20	35	CT	CT	CT	CT
Bell	B30E	31	20	35	CT	CT	CT	CT

CONTINUES ON NEXT PAGE

23.5-25 ARTICULATED DUMP TRUCK USAGE CHART CONTINUED

For Standard Earthmover Service: <2.5 mile, < 30 mph



Manufacturer	Model	Payload (tons)	Front Minimum Ply Rating	Front Minimum Inflation (psi)	Middle Minimum Ply Rating	Middle Minimum Inflation (psi)	Rear Minimum Ply Rating	Rear Minimum Inflation (psi)
Caterpillar	D20D	20	CT	CT	12	25	CT	CT
Caterpillar	D250B	25	20	35	20	40	20	40
Caterpillar	D250D	25	16	30	20	40	20	40
Caterpillar	D250E	25	20	40	CT	CT	CT	CT
Caterpillar	D300B	30	20	40	CT	CT	CT	CT
Caterpillar	D300D	30	20	40	CT	CT	CT	CT
Caterpillar	D300E	30	20	40	CT	CT	CT	CT
Caterpillar	D350C	35	CT	CT	CT	CT	CT	CT
Caterpillar	725	25	20	40	CT	CT	CT	CT
Caterpillar	725	26	CT	CT	CT	CT	CT	CT
Caterpillar	725C	26	CT	CT	CT	CT	CT	CT
Caterpillar	725C2	27	CT	CT	CT	CT	CT	CT
Caterpillar	730	30	CT	CT	CT	CT	CT	CT
Caterpillar	730	31	CT	CT	CT	CT	CT	CT
Caterpillar	730 EJ	31	CT	CT	CT	CT	CT	CT
Caterpillar	730C	31	CT	CT	CT	CT	CT	CT
Caterpillar	730C EJ	31	CT	CT	CT	CT	CT	CT
Caterpillar	730C2	31	CT	CT	CT	CT	CT	CT
Caterpillar	730C2 EJ	31	CT	CT	CT	CT	CT	CT
Deere	250C	25	20	35	16	30	20	35
Deere	250D	25	20	35	20	40	20	40
Deere	250D-II	25	20	35	20	40	20	40
Deere	260E	26	CT	CT	CT	CT	CT	CT
Deere	300C	30	20	40	CT	CT	CT	CT
Deere	300D	30	20	35	CT	CT	CT	CT
Deere	300D-II	30	20	40	CT	CT	CT	CT
Deere	310E	31	CT	CT	CT	CT	CT	CT
Doosan	DA30	31	CT	CT	CT	CT	CT	CT
Doosan	DA30-5	31	CT	CT	CT	CT	CT	CT
Komatsu	HA270-1	27	CT	CT	CT	CT	CT	CT
Komatsu	HM300-1	30	CT	CT	CT	CT	CT	CT
Komatsu	HM300-2	30	CT	CT	CT	CT	CT	CT
Komatsu	HM300-3	31	CT	CT	CT	CT	CT	CT
Komatsu	HM300-5	31	CT	CT	CT	CT	CT	CT
Moxy	MT26	26	CT	CT	CT	CT	CT	CT
Moxy	MT30X	30	CT	CT	20	35	20	35
Moxy	MT30LHS	30	CT	CT	CT	CT	CT	CT
Moxy	MT31	31	CT	CT	CT	CT	CT	CT
Randon	RK-628	28	20	35	CT	CT	CT	CT
Terex	2566B	25	CT	CT	20	35	20	35
Terex	2566C	25	CT	CT	20	40	20	35
Terex	2766B	28	CT	CT	20	40	20	40
Terex	2766C	28	CT	CT	CT	CT	20	40
Terex	3066	30	CT	CT	CT	CT	CT	CT
Terex	3066C	30	20	40	CT	CT	CT	CT
Terex	TA250	28	CT	CT	CT	CT	CT	CT

CONTINUES ON NEXT PAGE

23.5-25 ARTICULATED DUMP TRUCK USAGE CHART CONTINUED

For Standard Earthmover Service: <2.5 mile, < 30 mph



Manufacturer	Model	Payload (tons)	Front Minimum Ply Rating	Front Minimum Inflation (psi)	Middle Minimum Ply Rating	Middle Minimum Inflation (psi)	Rear Minimum Ply Rating	Rear Minimum Inflation (psi)
Terex	TA250-9	28	CT	CT	CT	CT	CT	CT
Terex	TA300	31	CT	CT	CT	CT	CT	CT
Terex	TA300-T4	31	CT	CT	CT	CT	CT	CT
Terex	TA300-9	31	CT	CT	CT	CT	CT	CT
Volvo	A20 6X4	20	12	25	-	-	-	-
Volvo	A25	25	16	30	20	40	20	40
Volvo	A25 4X4	25	16	35	-	-	-	-
Volvo	A25 6X4	25	16	30	20	40	20	40
Volvo	A25B	25	16	30	20	40	20	40
Volvo	A25B 4X4	25	16	35	-	-	-	-
Volvo	A25C	25	16	30	20	40	20	40
Volvo	A25C 4X4	25	20	35	-	-	-	-
Volvo	A25C 6X6	25	16	30	20	40	20	40
Volvo	A25D	27	20	40	CT	CT	CT	CT
Volvo	A25E	27	20	40	CT	CT	CT	CT
Volvo	A25E 4X4	27	CT	CT	-	-	-	-
Volvo	A25F	27	20	40	CT	CT	CT	CT
Volvo	A25G	27	CT	CT	CT	CT	CT	CT
Volvo	A30	30	20	40	CT	CT	CT	CT
Volvo	A30C	30	CT	CT	CT	CT	CT	CT
Volvo	A30C 6X6	30	CT	CT	CT	CT	CT	CT
Volvo	A30D	31	CT	CT	CT	CT	CT	CT
Volvo	A30E	31	CT	CT	CT	CT	CT	CT
Volvo	A30F	31	CT	CT	CT	CT	CT	CT
Volvo	A30G	31	CT	CT	CT	CT	CT	CT

Pressure and ply recommendations based on normal quarry operations with standard equipment. For different applications, or modified equipment, please contact OTR Field Engineering for a specific recommendation. Tire damage or failure caused by improper load, ply, speed or inflation practices is not covered by the Titan Tire Warranty Policy.

CT - Contact Titan Technical services

26.5-25 ARTICULATED DUMP TRUCK USAGE CHART

For Standard Earthmover Service: <2.5 mile, < 30 mph



Manufacturer	Model	Payload (tons)	Front Minimum Ply Rating	Front Minimum Inflation (psi)	Middle Minimum Ply Rating	Middle Minimum Inflation (psi)	Rear Minimum Ply Rating	Rear Minimum Inflation (psi)
Bell	B35D	36	26	45	32	55	32	55
Bell	B35E	37	32	50	44	55	32	55
Bell	B40	40	32	50	44	60	44	60
Bell	B40B	40	32	50	44	55	44	55
Bell	B40D 6x4	40	26	45	44	60	44	55
Caterpillar	D25C	25	32	50	CT	-	44	55
Caterpillar	D25D	25	32	50	CT	-	44	55
Caterpillar	D350C	35	26	45	26	45	26	45
Caterpillar	D350D	35	32	45	26	45	26	45
Caterpillar	D400D	40	32	50	44	55	44	55

CONTINUES ON NEXT PAGE

26.5-25 ARTICULATED DUMP TRUCK USAGE CHART CONTINUED

For Standard Earthmover Service: <2.5 mile, < 30 mph



Manufacturer	Model	Payload (tons)	Front Minimum Ply Rating	Front Minimum Inflation (psi)	Middle Minimum Ply Rating	Middle Minimum Inflation (psi)	Rear Minimum Ply Rating	Rear Minimum Inflation (psi)
Caterpillar	735	35	32	55	32	55	32	55
Caterpillar	735	36	44	55	32	55	32	50
Caterpillar	735B	36	44	60	32	55	32	50
Caterpillar	735B	36	44	60	32	55	32	50
Caterpillar	735C	36	32	55	32	55	32	50
Deere	350C	35	32	45	32	50	32	50
Deere	350D	35	26	45	32	50	32	50
Deere	350D Series II	35	32	50	32	50	32	50
Deere	370E	37	32	50	44	55	32	55
Komatsu	HM350-2	36	32	50	32	55	32	55
Moxy	MT36	36	32	45	32	50	32	50
Moxy	MT40	40	32	45	32	55	32	55
Terex	4066	37	20	40	32	50	32	50
Terex	4066B	40	26	45	44	55	44	55
Terex	4066C	40	26	45	44	60	44	60
Terex	TA350	38	26	40	44	60	44	60
Volvo	A35	35	20	40	32	50	32	50
Volvo	A35C	35	20	40	32	50	32	50
Volvo	A35C 6X6	35	20	40	32	50	32	50
Volvo	A35D	36	26	40	32	55	32	55
Volvo	A35E	37	26	40	44	55	44	55
Volvo	A35E-FS	37	26	40	44	55	44	55
Volvo	A35F	37	26	45	44	55	44	55
Volvo	A35F-FS	37	26	45	44	55	44	55
Volvo	A35G	37	32	45	44	55	44	55
Volvo	A35G-FS	37	32	45	44	55	44	55

Pressure and ply recommendations based on normal quarry operations with standard equipment. For different applications, or modified equipment, please contact OTR Field Engineering for a specific recommendation. Tire damage or failure caused by improper load, ply, speed or inflation practices is not covered by the Titan Tire Warranty Policy.

CT - Contact Titan Technical services

29.5-25 ARTICULATED DUMP TRUCK USAGE CHART

For Standard Earthmover Service: <2.5 mile, < 30 mph



Manufacturer	Model	Payload (tons)	Front Minimum Ply Rating	Front Minimum Inflation (psi)	Middle Minimum Ply Rating	Middle Minimum Inflation (psi)	Rear Minimum Ply Rating	Rear Minimum Inflation (psi)
Atlas	FB-645	45	34	55	34	60	34	60
Bell	B40B	40	28	45	28	50	28	45
Bell	B40D	41	28	40	34	50	34	50
Bell	B40E	43	28	45	34	55	34	55
Bell	B45D	45	28	45	38	60	34	60
Bell	B45E	45	28	45	34	55	34	55
Bell	B50E	50	34	50	CT	CT	CT	CT
Caterpillar	D30C 4x4	30	28	45	-	-	38	60
Caterpillar	D30D 4x4	30	28	45	-	-	38	60

CONTINUES ON NEXT PAGE

29.5-25 ARTICULATED DUMP TRUCK USAGE CHART CONTINUED

For Standard Earthmover Service: <2.5 mile, < 30 mph



Manufacturer	Model	Payload (tons)	Front Minimum Ply Rating	Front Minimum Inflation (psi)	Middle Minimum Ply Rating	Middle Minimum Inflation (psi)	Rear Minimum Ply Rating	Rear Minimum Inflation (psi)
Caterpillar	D35C	35	28	45	-	-	CT	-
Caterpillar	D40D	40	34	55	-	-	CT	-
Caterpillar	D350C	35	28	35	28	40	28	35
Caterpillar	D350D	35	28	40	28	40	28	40
Caterpillar	D400D	40	28	45	28	45	28	45
Caterpillar	D400E	40	28	45	28	45	28	45
Caterpillar	740	40	34	50	28	50	28	45
Caterpillar	740	44	34	55	34	55	34	50
Caterpillar	740 EJ	42	28	45	38	60	34	55
Caterpillar	740B	44	34	55	34	55	34	50
Caterpillar	740B EJ	42	28	50	34	60	34	55
Caterpillar	740C EJ	42	28	45	34	60	34	55
Caterpillar	740 GC	40	28	50	34	50	28	50
Caterpillar	745C	45	34	55	34	55	34	55
Deere	370E	37	28	45	28	45	28	45
Deere	400C	40	28	45	28	45	28	45
Deere	400D	40	28	40	34	50	34	50
Deere	400D Series II	40	28	40	34	55	34	50
Deere	410E	41	28	45	34	50	34	50
Deere	460E	46	28	50	34	55	34	55
Doosan	DA40	44	28	45	34	55	34	55
Doosan	DA40-5	44	28	45	34	55	34	55
Komatsu	HD400	40	28	40	34	50	34	50
Komatsu	HM400-2	40	28	40	34	55	34	55
Komatsu	HM400-3	44	28	45	34	60	34	60
Komatsu	HM400-5	44	28	50	38	60	34	55
Moxy	MT41	41	28	40	34	50	34	50
Moxy	MT51	51	28	45	38	60	38	60
Terex	TA400-9	42	28	40	34	55	34	55
Volvo	A40	40	28	35	34	50	34	50
Volvo	A40D	41	28	40	34	55	34	55
Volvo	A40E	43	28	40	34	55	34	55
Volvo	A40E-FS	43	28	40	34	55	34	55
Volvo	A40F	43	28	45	34	55	34	55
Volvo	A40F-FS	43	28	40	34	55	34	55
Volvo	A40G	43	28	45	34	55	34	55
Volvo	A40G-FS	43	28	45	34	55	34	55
Volvo	A45G	45	28	45	34	55	34	55
Volvo	A45G-FS	45	28	45	34	55	34	55
Volvo	A25 4X4	25	-	-	-	-	34	55
Volvo	A25B 4X4	25	-	-	-	-	34	55
Volvo	A25C 4X4	25	-	-	-	-	34	55
Volvo	A25E 4X4	27	-	-	-	-	38	65

Pressure and ply recommendations based on normal quarry operations with standard equipment. For different applications, or modified equipment, please contact OTR Field Engineering for a specific recommendation. Tire damage or failure caused by improper load, ply, speed or inflation practices is not covered by the Titan Tire Warranty Policy.

CT - Contact Titan Technical services

BIAS GRADER

13.00-24TG GRADER USAGE CHART

For Standard Grader Service: Unlimited distance, < 25 mph



Manufacturer	Model	Front Minimum Ply Rating	Front Minimum Inflation (psi)	Middle Minimum Ply Rating	Middle Minimum Inflation (psi)	Rear Minimum Ply Rating	Rear Minimum Inflation (psi)
Case	845B	12	35	12	45	12	45
Case	865B	12	40	12	45	12	45
Case	865B AWD	12	40	16	45	16	45
Caterpillar	12M	12	45	CT	CT	CT	CT
Caterpillar	120M2	12	40	CT	CT	CT	CT
Caterpillar	120M2 AWD	12	45	CT	CT	CT	CT

Pressure and ply recommendations based on normal quarry operations with standard equipment. For different applications, or modified equipment, please contact OTR Field Engineering for a specific recommendation. Tire damage or failure caused by improper load, ply, speed or inflation practices is not covered by the Titan Tire Warranty Policy.

CT - Contact Titan Technical services

14.00-24TG GRADER USAGE CHART

For Standard Grader Service: Unlimited distance, < 25 mph



Manufacturer	Model	Front Minimum Ply Rating	Front Minimum Inflation (psi)	Middle Minimum Ply Rating	Middle Minimum Inflation (psi)	Rear Minimum Ply Rating	Rear Minimum Inflation (psi)
Case	845B	12	25	12	40	12	40
Case	865B	12	25	12	40	12	40
Case	865B AWD	12	30	12	40	12	40
Case	885B	12	35	14	40	14	40
Case	885B AWD	12	40	14	40	14	40
Caterpillar	12M	12	30	14	40	14	40
Caterpillar	12M2	12	35	14	45	14	45
Caterpillar	12M2 AWD	12	35	CT	CT	CT	CT
Caterpillar	12M3	12	35	CT	CT	CT	CT
Caterpillar	12M3 AWD	12	35	CT	CT	CT	CT
Caterpillar	120M2	12	30	14	40	14	40
Caterpillar	120M2 AWD	12	30	14	45	14	45
Caterpillar	140	12	30	16	45	16	45
Caterpillar	140H	12	25	12	40	12	40
Caterpillar	140M	12	30	14	45	14	45
Caterpillar	140M AWD	12	35	CT	CT	CT	CT
Caterpillar	140M2	12	35	CT	CT	CT	CT
Caterpillar	140M2 AWD	12	40	CT	CT	CT	CT
Caterpillar	140M3	12	35	CT	CT	CT	CT
Caterpillar	140M3 AWD	14	40	CT	CT	CT	CT
Caterpillar	160M	12	35	CT	CT	CT	CT
Caterpillar	160M AWD	12	40	CT	CT	CT	CT
Caterpillar	160M2	12	35	CT	CT	CT	CT
Caterpillar	160M2 AWD	14	40	CT	CT	CT	CT
Caterpillar	160M3	12	35	CT	CT	CT	CT
Caterpillar	160M3 AWD	14	40	CT	CT	CT	CT

CONTINUES ON NEXT PAGE

14.00-24TG GRADER USAGE CHART CONTINUED

For Standard Grader Service: Unlimited distance, < 25 mph



Manufacturer	Model	Front Minimum Ply Rating	Front Minimum Inflation (psi)	Middle Minimum Ply Rating	Middle Minimum Inflation (psi)	Rear Minimum Ply Rating	Rear Minimum Inflation (psi)
Deere	620G/GP	12	30	14	45	14	45
Deere	622G/GP	12	35	14	45	14	45
Deere	670G Std	12	25	12	40	12	40
Deere	670G w/ ripper	12	35	14	45	14	45
Deere	672G Std	12	30	12	40	12	40
Deere	672G w/ ripper	12	35	CT	CT	CT	CT
Deere	770C std	12	25	12	40	12	40
Deere	770C w/ scarifier	12	30	12	40	12	40
Deere	770C w/ ripper	12	25	12	40	12	40
Deere	770CH std	12	25	12	40	12	40
Deere	770CH w/ scarifier	12	30	12	40	12	40
Deere	770CH w/ ripper	12	25	12	40	12	40
Deere	770G std	12	25	12	40	12	40
Deere	770G w/ ripper	12	35	CT	CT	CT	CT
Deere	772CH std	12	25	12	40	12	40
Deere	772CH w/ scarifier	12	35	12	40	12	40
Deere	772CH w/ ripper	12	30	12	40	12	40
Deere	772D std	12	25	12	40	12	40
Deere	772D w/ ripper	12	30	14	40	14	40
Deere	772G std	12	30	14	40	14	40
Deere	772G w/ ripper	12	40	CT	CT	CT	CT
Deere	870G std	12	25	14	40	14	40
Deere	870G w/ ripper	12	35	CT	CT	CT	CT
Deere	872G std	12	30	14	40	14	40
Deere	872G w/ ripper	14	40	CT	CT	CT	CT
Terex	TG140	12	30	12	40	12	40
Terex	TG180	14	40	12	40	12	40
Terex	TG200	14	40	12	40	12	40
Volvo	G930B	12	25	12	40	12	40
Volvo	G930C	12	25	12	40	12	40
Volvo	G940B	12	30	12	40	12	40
Volvo	G940C	12	30	14	40	14	40
Volvo	G946B	12	30	14	40	14	40
Volvo	G946C	12	30	14	40	14	40
Volvo	G960B	12	30	14	40	14	40
Volvo	G960C	12	30	14	40	14	40

Pressure and ply recommendations based on normal quarry operations with standard equipment. For different applications, or modified equipment, please contact OTR Field Engineering for a specific recommendation. Tire damage or failure caused by improper load, ply, speed or inflation practices is not covered by the Titan Tire Warranty Policy.

CT - Contact Titan Technical services

16.00-24TG GRADER USAGE CHART

For Standard Grader Service: Unlimited distance, < 25 mph



Manufacturer	Model	Front Minimum Ply Rating	Front Minimum Inflation (psi)	Middle Minimum Ply Rating	Middle Minimum Inflation (psi)	Rear Minimum Ply Rating	Rear Minimum Inflation (psi)
Case	845B	16	20	16	40	16	40
Case	865B	16	20	16	40	16	40
Case	865B AWD	16	25	16	40	16	40
Case	885B	16	25	16	40	16	40
Case	885B AWD	16	30	16	40	16	40
Caterpillar	14M	16	30	CT	CT	CT	CT

Pressure and ply recommendations based on normal quarry operations with standard equipment. For different applications, or modified equipment, please contact OTR Field Engineering for a specific recommendation. Tire damage or failure caused by improper load, ply, speed or inflation practices is not covered by the Titan Tire Warranty Policy.

CT - Contact Titan Technical services

17.5-25 GRADER USAGE CHART

For Standard Grader Service: Unlimited distance, < 25 mph



Manufacturer	Model	Front Minimum Ply Rating	Front Minimum Inflation (psi)	Middle Minimum Ply Rating	Middle Minimum Inflation (psi)	Rear Minimum Ply Rating	Rear Minimum Inflation (psi)
Case	845B	12	20	12	40	12	40
Case	856C	12	20	12	40	12	40
Case	856C AWD	12	20	12	40	12	40
Case	865B	12	25	12	40	12	40
Case	865B AWD	12	25	12	40	12	40
Case	885B	12	30	16	40	16	40
Case	885B AWD	16	CT	16	40	16	40
Caterpillar	12M	12	25	16	40	16	40
Caterpillar	12M2	12	30	20	40	20	40
Caterpillar	12M2 AWD	16	CT	20	40	20	40
Caterpillar	12M3	12	30	20	40	20	40
Caterpillar	12M3 AWD	16	CT	20	40	20	40
Caterpillar	120M2	12	25	16	40	16	40
Caterpillar	120M2 AWD	12	30	20	40	20	40
Caterpillar	140H	12	20	12	40	12	40
Caterpillar	140M	12	30	20	40	20	40
Caterpillar	140M AWD	12	30	20	40	20	40
Caterpillar	140M2	12	30	20	40	20	40
Caterpillar	140M2 AWD	16	CT	20	40	20	40
Caterpillar	140M3	12	30	20	40	20	40
Caterpillar	140M3 AWD	16	CT	CT	40	CT	40
Caterpillar	160M	12	30	20	40	20	40
Caterpillar	160M AWD	16	CT	20	40	20	40
Caterpillar	160M2	16	CT	20	40	20	40
Caterpillar	160M2 AWD	16	CT	CT	CT	CT	CT
Caterpillar	160M3	16	CT	CT	40	CT	40
Caterpillar	160M3 AWD	16	CT	CT	CT	CT	CT
Deere	620G/GP	12	25	16	40	16	40
Deere	622G/GP	12	30	20	40	20	40

CONTINUES ON NEXT PAGE

17.5-25 GRADER USAGE CHART CONTINUED

For Standard Grader Service: Unlimited distance, < 25 mph



Manufacturer	Model	Front Minimum Ply Rating	Front Minimum Inflation (psi)	Middle Minimum Ply Rating	Middle Minimum Inflation (psi)	Rear Minimum Ply Rating	Rear Minimum Inflation (psi)
Deere	670G Std	12	20	16	40	16	40
Deere	670G w/ ripper	12	30	20	40	20	40
Deere	672G Std	12	25	16	40	16	40
Deere	672G w/ ripper	16	CT	20	40	20	40
Deere	770C std	12	20	12	40	12	40
Deere	770C w/ scarifier	12	25	12	40	12	40
Deere	770C w/ ripper	12	25	16	40	16	40
Deere	770CH std	12	20	12	40	12	40
Deere	770CH w/ scarifier	12	25	12	40	12	40
Deere	770CH w/ ripper	12	25	16	40	16	40
Deere	770G std	12	20	16	40	16	40
Deere	770G w/ ripper	12	30	20	40	20	40
Deere	772CH std	12	25	12	40	12	40
Deere	772CH w/ scarifier	12	30	12	40	12	40
Deere	772CH w/ ripper	12	25	16	40	16	40
Deere	772D std	12	20	12	40	12	40
Deere	772D w/ ripper	12	25	16	40	16	40
Deere	772G std	12	25	16	40	16	40
Deere	772G w/ ripper	16	CT	20	40	20	40
Deere	870G std	12	25	16	40	16	40
Deere	870G w/ ripper	12	30	20	40	20	40
Deere	872G std	12	25	16	40	16	40
Deere	872G w/ ripper	16	CT	CT	CT	CT	CT
Komatsu	GD655-5	12	25	12	40	12	40
Komatsu	GD655-5 w/ ripper	12	30	16	40	16	40
Komatsu	GD655-5 w/ scarifier	12	25	16	40	16	40
Komatsu	GD655-6	12	20	16	40	16	40
Komatsu	GD655-6 w/ ripper	12	25	20	40	20	40
Komatsu	GD655-6 w/ scarifier	12	25	16	40	16	40
Komatsu	GD655-7	12	20	16	40	16	40
Volvo	G930B	12	25	12	40	12	40
Volvo	G930C	12	25	20	40	20	40
Volvo	G940B	12	25	16	40	16	40
Volvo	G940C	12	25	CT	CT	CT	CT
Volvo	G946B	12	25	16	40	16	40
Volvo	G946C	12	30	CT	CT	CT	CT
Volvo	G960B	12	25	16	40	16	40
Volvo	G960C	12	30	CT	CT	CT	CT

Pressure and ply recommendations based on normal quarry operations with standard equipment. For different applications, or modified equipment, please contact OTR Field Engineering for a specific recommendation. Tire damage or failure caused by improper load, ply, speed or inflation practices is not covered by the Titan Tire Warranty Policy.

CT - Contact Titan Technical services

BIAS LOADER

15.5-25 LOADER USAGE CHART

For Standard Loader Service: <250 ft, < 5 mph



Manufacturer	Model	Bucket (cu. yd.)	Front Minimum Ply Rating	Front Minimum Inflation (psi)	Rear Minimum Ply Rating	Rear Minimum Inflation (psi)
Caterpillar	910K	1.7	12	55	12	35
Caterpillar	910M	2.5	12	70	12	40
Caterpillar	914G2	1.8	24	55	24	35
Hitachi	ZW100	1.7	24	55	24	35
Hitachi	ZW100 HL	1.4	24	50	24	35
Komatsu	WA150-5	1.6	24	50	24	35
Volvo	L45H	2	24	65	24	40
Volvo	L50H	2.1	24	70	24	40

For service under chains, or load and carry operations, contact Titan Technical Services.

Pressure and ply recommendations based on normal quarry operations with standard equipment. For different applications, or modified equipment, please contact OTR Field Engineering for a specific recommendation. Tire damage or failure caused by improper load, ply, speed or inflation practices is not covered by the Titan Tire Warranty Policy.

CT - Contact Titan Technical services

HL - High Lift, extended booms, etc.

17.5-25 LOADER USAGE CHART

For Standard Loader Service: <250 ft, < 5 mph



Manufacturer	Model	Bucket (cu. yd.)	Front Minimum Ply Rating	Front Minimum Inflation (psi)	Rear Minimum Ply Rating	Rear Minimum Inflation (psi)	Manufacturer	Model	Bucket (cu. yd.)	Front Minimum Ply Rating	Front Minimum Inflation (psi)	Rear Minimum Ply Rating	Rear Minimum Inflation (psi)
Caterpillar	IT14B	1.6	12	50	12	35	Caterpillar	924Gz	2.3	12	60	12	35
Caterpillar	IT14F	1.6	12	50	12	35	Caterpillar	924K	2.5	16	75	12	45
Caterpillar	IT14G	1.7	12	45	12	35	Caterpillar	926	1.75	12	50	12	35
Caterpillar	IT18	1.5	12	50	12	35	Caterpillar	926E	2.25	12	55	12	35
Caterpillar	IT18B	1.75	12	55	12	35	Caterpillar	926M	2.5	16	75	12	45
Caterpillar	IT18F	2	12	60	12	35	Caterpillar	928F	2.6	12	65	12	35
Caterpillar	IT24	2.3	12	60	12	35	Caterpillar	928G	2.6	12	65	12	40
Caterpillar	IT24F	2.4	12	65	12	35	Caterpillar	930	2.25	12	60	12	35
Caterpillar	IT28	2	12	55	12	35	Caterpillar	936	2.75	16	75	12	45
Caterpillar	IT28B	2.25	12	60	12	35	Caterpillar	936E	3	16	80	12	45
Caterpillar	IT28F	2.6	12	65	12	40	Caterpillar	936F	3	16	80	12	45
Caterpillar	910M	2.5	12	60	12	35	Case	W14C	1.7	12	45	12	35
Caterpillar	914G	1.7	12	45	12	35	Case	W18	2	12	55	12	35
Caterpillar	914G2	1.8	12	50	12	35	Case	W18B	2	12	55	12	35
Caterpillar	914K	1.7	12	45	12	35	Case	W20	2	12	60	12	35
Caterpillar	914K HL	1.7	12	50	12	35	Case	W20B	2.5	12	60	12	35
Caterpillar	914M	2.5	12	60	12	35	Case	W20C	2	12	55	12	35
Caterpillar	916	2	12	50	12	35	Case	W24B	2.5	12	60	12	35
Caterpillar	918F	2	12	55	12	35	Case	W24C	3	16	70	12	40
Caterpillar	918M	2.5	12	60	12	35	Case	521D	2	12	55	12	35
Caterpillar	924F	2.25	12	55	12	35	Case	521G Z-Bar	2.1	12	60	12	35

CONTINUES ON NEXT PAGE

17.5-25 LOADER USAGE CHART CONTINUED

For Standard Loader Service: <250 ft, < 5 mph



Manufacturer	Model	Bucket (cu. yd.)	Front Minimum Ply Rating	Front Minimum Inflation (psi)	Rear Minimum Ply Rating	Rear Minimum Inflation (psi)
Case	521G Z-Bar	2	12	55	12	35
Case	521G Z-Bar	2.3	12	60	12	35
Case	521G XR	2.1	12	60	12	35
Case	521G XR	2	12	60	12	35
Case	521G XR	2.3	12	65	12	35
Case	521G XT	2.1	12	60	12	35
Case	521G XT	2	12	60	12	35
Case	621	2.2	12	65	12	35
Daewoo	Mega 200	2.4	12	60	12	35
Daewoo	Mega 200-III	2.3	12	60	12	35
Deere	304H	1.25	12	50	12	35
Deere	304H WH	1	12	45	12	35
Deere	324H	1.75	12	55	12	35
Deere	344E	1.6	12	45	12	35
Deere	344G	1.6	12	45	12	35
Deere	344H	2	12	45	12	35
Deere	344K	1.75	12	50	12	35
Deere	344L	2	12	55	12	35
Deere	344L HL	2	12	55	12	35
Deere	444	1.5	12	45	12	35
Deere	444C	1.75	12	50	12	35
Deere	444D	1.75	12	50	12	35
Deere	444E	1.75	12	50	12	35
Deere	444G	1.75	12	50	12	35
Deere	444H	2.5	12	60	12	35
Deere	444H-HL	2.5	12	65	12	40
Deere	444K Z-bar	2.5	12	65	12	40
Deere	444K HL	2.5	16	70	12	40
Deere	444K Powerflex	2.5	16	75	12	45
Deere	544B	1.75	12	55	12	35
Deere	544C	2	12	55	12	35
Deere	544D	2.2	12	60	12	35
Deere	544E	2.2	12	60	12	35
Deere	544G	2.5	12	65	12	35
Deere	544G-TC	2.5	12	65	12	40
Deere	TC44H	2	12	55	12	35
Deere	TC54H	2.5	12	60	12	35
Deere	TC62H	3	12	60	12	35
Fiatallis	FR7B	1.4	12	40	12	35
Fiatallis	FR7C	1.4	12	40	12	35
Fiatallis	FR70	1.4	12	40	12	35
Fiatallis	345B	1.5	12	45	12	35
Fiatallis	FR9B PL	1.7	12	50	12	35
Fiatallis	FR90 PL	1.8	12	55	12	35
Fiatallis	FR9B	1.8	12	50	12	35

Manufacturer	Model	Bucket (cu. yd.)	Front Minimum Ply Rating	Front Minimum Inflation (psi)	Rear Minimum Ply Rating	Rear Minimum Inflation (psi)
Fiatallis	FR9C	1.8	12	45	12	35
Fiatallis	FR90	1.8	12	50	12	35
Fiatallis	FR10	2	12	55	12	35
Fiatallis	FR10B	2.2	12	55	12	35
Fiatallis	FR10C	2.25	12	55	12	35
Fiatallis	FR100	2.25	12	55	12	35
Fiatallis	FR11	2.5	12	65	12	40
Fiatallis	FR12	2.5	12	65	12	40
Fiatallis	FR12B	2.5	12	60	12	35
Fiatallis	FR120	2.5	12	60	12	35
Fiatallis	FR120-2	2.5	12	65	12	40
Fiatallis	FW130	2.75	16	70	12	45
Fiatallis	FW110	2.2	12	55	12	35
Fiat Hitachi	W110	2.1	12	55	12	35
Fiat Hitachi	W130 PL	2.6	12	65	12	40
Furukawa	FL120-I	1.7	12	50	12	35
Furukawa	FL120A-I	1.7	12	50	12	35
Hitachi	ZW120	2	12	50	12	35
Hitachi	ZW120 HL	1.75	12	50	12	35
Hitachi	ZW120-6	2	12	50	12	35
Hitachi	ZW120-6 HL	2	12	55	12	35
Hitachi	ZW140	2.6	12	65	12	35
Hitachi	ZW140 HL	2	12	60	12	35
Hitachi	ZW140-6	2.7	12	65	12	40
Hitachi	ZW140-6 HL	2.7	16	70	12	40
Hyundai	HL17	2.4	12	65	12	40
Hyundai	HL730-9A	2.5	12	60	12	35
Hyundai	HL730XTD-9A	2.5	12	65	12	35
Hyundai	HL730TM-9A	2.2	12	60	12	35
Hyundai	HL740-9A	3	16	80	12	45
Hyundai	HL740XTD-9A	3	20	80	12	50
Hyundai	HL740TM-9A	3	20	85	12	55
Hyundai	HL757-9A	3.7	20	90	16	55
Hyundai	HL757XTD-9A	3.7	24	100	16	65
Hyundai	HL757TM-9A	3.5	24	95	16	60
Hyundai	HL940	3	16	75	12	45
Hyundai	HL940 XT	3	16	80	12	50
Hyundai	HL955	3.1	20	85	12	50
Hyundai	HL955 XTD	3.1	20	90	16	55
JCB	411HT	1.6	12	45	12	35
JCB	416HT	2.2	12	55	12	35
JCB	417HT	2	12	55	12	35
JCB	417HT HL	2	12	55	12	35
JCB	417HT SHL	2	12	60	12	35
Kawasaki	50ZIV	1.7	12	45	12	35

CONTINUES ON NEXT PAGE

17.5-25 LOADER USAGE CHART CONTINUED

For Standard Loader Service: <250 ft, < 5 mph



Manufacturer	Model	Bucket (cu. yd.)	Front Minimum Ply Rating	Front Minimum Inflation (psi)	Rear Minimum Ply Rating	Rear Minimum Inflation (psi)
Kawasaki	50ZIV-2	2	12	45	12	35
Kawasaki	60Z	2.1	12	55	12	35
Kawasaki	60ZII	2.1	12	55	12	35
Kawasaki	60ZIII	2.1	12	50	12	35
Kawasaki	60ZIV	2.1	12	50	12	35
Kawasaki	60ZIV-2	2.5	12	55	12	35
Kawasaki	60Z7	2	12	50	12	35
Kawasaki	60ZV-2	2.2	12	55	12	35
Kawasaki	60ZV-2 HL	2.2	12	60	12	35
Kawasaki	60ZV-2 SHL	2.2	12	60	12	35
Kawasaki	62Z7	2.75	12	65	12	40
Kawasaki	65TM-2	2.6	16	80	12	50
Kawasaki	65Z	2.3	12	60	12	35
Kawasaki	65ZII	2.3	12	60	12	35
Kawasaki	65ZIII	2.6	12	65	12	35
Kawasaki	65ZIV	2.6	12	65	12	35
Kawasaki	65ZIV-2	3	16	70	12	45
Kawasaki	65ZV-2	3	16	70	12	40
Kawasaki	65ZV-2 HL	2.8	16	70	12	40
Kawasaki	65ZV-2 SHL	2.8	16	70	12	45
Komatsu	WA120-1	1.75	12	50	12	35
Komatsu	WA120-3	1.85	12	45	12	35
Komatsu	WA150-5	2	12	50	12	35
Komatsu	WA180-1	2.25	12	55	12	35
Komatsu	WA180-3	2.9	12	65	12	35
Komatsu	WA180-3 PTC	2.5	12	65	12	35
Komatsu	WA200-5	2.6	12	60	12	35
Komatsu	WA200-6	2.6	12	60	12	35
Komatsu	WA200PZ-6	2.6	12	65	12	40
Komatsu	WA200-7	2.6	12	65	12	40
Komatsu	WA200-8	2.6	12	65	12	40
Komatsu	WA250-5	3	16	70	12	40
Komatsu	WA250-6	3	12	65	12	40
Komatsu	WA250PZ-6	2.9	16	75	12	45
Komatsu Dresser	512	1.7	12	50	12	35
Komatsu Dresser	515B	1.6	12	45	12	35
Komatsu Dresser	515C	2	12	50	12	35
Komatsu Dresser	515CH	2	12	55	12	35
Komatsu Dresser	518	2.2	12	55	12	35
Komatsu Dresser	520B	2.25	12	60	12	35
Komatsu Dresser	520C	2.5	12	60	12	35

Manufacturer	Model	Bucket (cu. yd.)	Front Minimum Ply Rating	Front Minimum Inflation (psi)	Rear Minimum Ply Rating	Rear Minimum Inflation (psi)
Liebherr	L524 Z-bar	2.7	12	65	12	40
Liebherr	L524	2.4	12	65	12	40
Liebherr	L524 HL	2.4	16	70	12	45
Liebherr	L526 Z-bar	2.75	12	70	12	40
Liebherr	L526	2.75	16	75	12	45
Liebherr	L526 HL	2.75	16	80	12	50
Liebherr	L528 Z-bar	3	16	70	12	40
Liebherr	L528	2.7	16	70	12	40
Liebherr	L528 HL	2.7	16	80	12	45
Terex	33C	1.75	12	50	12	35
Terex	44C	2.25	12	65	12	40
Volvo	L45H	2	12	55	12	35
Volvo	L50C	2	12	50	12	35
Volvo	L50D	2	12	55	12	35
Volvo	L50H	2.1	12	55	12	35
Volvo	L60G	2.75	16	70	12	40
Volvo	L60H	2.75	16	70	12	40
Volvo	L70B	2.1	12	60	12	35
Volvo	L70C	2.5	12	60	12	35
Volvo	L70D	2.5	12	65	12	40

For service under chains, or load and carry operations, contact Titan Technical Services.

Pressure and ply recommendations based on normal quarry operations with standard equipment. For different applications, or modified equipment, please contact OTR Field Engineering for a specific recommendation. Tire damage or failure caused by improper load, ply, speed or inflation practices is not covered by the Titan Tire Warranty Policy.

CT - Contact Titan Technical services
HL - High Lift, extended booms, etc.

20.5-25 LOADER USAGE CHART

For Standard Loader Service: <250 ft, < 5 mph

*This excludes HK 458, see pages 83-85 for HK 458 pressures



Manufacturer	Model	Bucket (cu. yd.)	Front Minimum Ply Rating	Front Minimum Inflation (psi)	Rear Minimum Ply Rating	Rear Minimum Inflation (psi)	Manufacturer	Model	Bucket (cu. yd.)	Front Minimum Ply Rating	Front Minimum Inflation (psi)	Rear Minimum Ply Rating	Rear Minimum Inflation (psi)
Caterpillar	IT38F	3.25	16	60	12	35	Case	621G XT	2.4	12	50	12	35
Caterpillar	IT38G	3.3	16	60	12	35	Case	621G XT	3	16	55	12	35
Caterpillar	IT38H	3.3	16	65	12	35	Case	621G XT	2.8	16	55	12	35
Caterpillar	924G	2.3	12	45	12	35	Case	721	2.75	12	50	12	35
Caterpillar	924H	2.4	12	45	12	35	Case	721B	2.75	12	50	12	35
Caterpillar	924HZ	2.3	12	45	12	35	Case	721B XT	2.75	16	55	12	35
Caterpillar	924K	2.5	12	55	12	35	Case	721C	2.75	16	55	12	35
Caterpillar	926M	2.5	16	55	12	35	Case	721E	3.5	16	60	12	35
Caterpillar	928HZ	2.6	12	50	12	35	Case	721E XT	3	16	55	12	35
Caterpillar	930H	2.7	12	55	12	35	Case	721E XR	3	16	55	12	35
Caterpillar	930K	2.75	16	55	12	35	Case	721F	3	16	55	12	35
Caterpillar	930M	2.75	16	55	12	35	Case	721F XT	3	16	60	12	35
Caterpillar	930M HL	2.7	16	60	12	35	Case	721F XR	3	16	60	12	35
Caterpillar	936F TC	3	16	55	12	35	Case	721G Z-Bar	3	16	55	12	35
Caterpillar	938F	3.25	16	55	12	35	Case	721G Z-Bar	2.8	16	55	12	35
Caterpillar	938G	3.25	16	60	12	35	Case	721G Z-Bar	3.25	16	60	12	35
Caterpillar	938H	3.65	20	65	16	40	Case	721G XR	3	16	60	12	35
Caterpillar	938K	3.25	16	65	12	35	Case	721G XR	2.8	16	55	12	35
Caterpillar	938M	3.25	20	65	16	40	Case	721G XR	3.25	16	60	12	35
Caterpillar	938M HL	3.2	20	70	16	40	Case	721G XT	3	16	60	12	35
Caterpillar	950B	3.75	20	70	16	40	Case	721G XT	2.8	16	55	12	35
Caterpillar	950F	4	20	75	16	45	Case	W30	3.5	16	55	12	35
Case	521G Z-Bar	2.1	12	45	12	35	Daewoo	Mega 250-III	3.1	16	55	12	35
Case	521G Z-Bar	2	12	40	12	35	Deere	444K Z-bar	2.5	12	50	12	35
Case	521G Z-Bar	2.3	12	45	12	35	Deere	444K HL	2.5	12	50	12	35
Case	521G XR	2.1	12	45	12	35	Deere	444K Powerlel	2.5	12	50	12	35
Case	521G XR	2	12	45	12	35	Deere	524K Z-bar	2.75	12	50	12	35
Case	521G XR	2.3	12	45	12	35	Deere	524K HL	2.75	12	55	12	35
Case	521G XT	2.1	12	45	12	35	Deere	524L	2.75	12	50	12	35
Case	521G XT	2	12	45	12	35	Deere	524L HL	2.75	16	55	12	35
Case	621B	2.25	12	45	12	35	Deere	544H	3	12	55	12	35
Case	621B	3	12	55	12	35	Deere	544H-HL	3	16	55	12	35
Case	621B XT	2.25	12	50	12	35	Deere	544J	3	12	55	12	35
Case	621D	2.5	12	50	12	35	Deere	544J-HL	3	16	55	12	35
Case	621E	3	12	55	12	35	Deere	544K	3	16	55	12	35
Case	621E XT	3	16	55	12	35	Deere	544K-HL	3	16	55	12	35
Case	621E XR	3	16	55	12	35	Deere	544L	3	16	55	12	35
Case	621G Z-Bar	2.5	12	50	12	35	Deere	544L HL	2.75	16	55	12	35
Case	621G Z-Bar	2.4	12	45	12	35	Deere	624E	2.6	12	50	12	35
Case	621G Z-Bar	2.75	12	50	12	35	Deere	624G	3.25	16	55	12	35
Case	621G XR	2.5	12	50	12	35	Deere	624H	3.5	16	60	12	35
Case	621G XR	2.4	12	50	12	35	Deere	624H-HL	3	16	60	12	35
Case	621G XR	2.75	12	55	12	35	Deere	624K	3.5	16	60	12	35
Case	621G XT	2.5	12	50	12	35	Deere	624K-HL	3.5	16	65	12	35

CONTINUES ON NEXT PAGE

20.5-25 LOADER USAGE CHART CONTINUED

For Standard Loader Service: <250 ft, < 5 mph

*This excludes HK 458, see pages 83-85 for HK 458 pressures



Manufacturer	Model	Bucket (cu. yd.)	Front Minimum Ply Rating	Front Minimum Inflation (psi)	Rear Minimum Ply Rating	Rear Minimum Inflation (psi)	Manufacturer	Model	Bucket (cu. yd.)	Front Minimum Ply Rating	Front Minimum Inflation (psi)	Rear Minimum Ply Rating	Rear Minimum Inflation (psi)
Deere	624L	3.5	16	65	12	35	Hitachi	ZW180-5 HL	3.1	16	60	12	35
Deere	624L HL	3.5	20	65	16	40	Hitachi	ZW180-6	3.7	16	65	12	35
Deere	644B	2.5	12	50	12	35	Hitachi	ZW180-6 HL	3.7	20	70	16	40
Deere	644C	3	12	55	12	35	Hyundai	HL25	3.5	20	70	16	40
Doosan	DL200	2.6	12	50	12	35	Hyundai	HL740-7A	2.7	12	50	12	35
Doosan	DL200TC	2.6	12	50	12	35	Hyundai	HL740XTD-7A	2.7	12	50	12	35
Doosan	DL200-5	2.6	12	50	12	35	Hyundai	HL740TM-7A	2.6	12	50	12	35
Doosan	DL200-5 HL	2.6	12	50	12	35	Hyundai	HL740-9A	3	16	55	12	35
Doosan	DL200TC-5	2.6	12	50	12	35	Hyundai	HL740XTD-9A	3	16	60	12	35
Doosan	DL220-5	3	16	55	12	35	Hyundai	HL740TM-9A	3	16	60	12	35
Doosan	DL220-5 HL	3	16	55	12	35	Hyundai	HL750	3	16	55	12	35
Doosan	DL250	3.3	16	60	12	35	Hyundai	HL757-7A	2.7	16	55	12	35
Doosan	DL250TC	3.4	16	65	12	35	Hyundai	HL757XTD-7A	2.7	16	55	12	35
Doosan	DL250HL	3.4	16	60	12	35	Hyundai	HL757TM-7A	2.5	16	55	12	35
Doosan	DL250-5	3.3	16	60	12	35	Hyundai	HL757-9A	3.7	16	65	12	35
Doosan	DL250-5 HL	3.3	16	60	12	35	Hyundai	HL757XTD-9A	3.7	20	70	16	40
Doosan	DL250TC-5	3.3	16	60	12	35	Hyundai	HL757TM-9A	3.5	20	70	16	40
Doosan	DL280-5	3.7	20	65	12	40	Hyundai	HL760-9A	4.3	24	75	16	45
Doosan	DL280-5 HL	3.7	20	70	16	40	Hyundai	HL760XTD-9A	4.3	24	80	16	50
Dressta	520E	2.3	12	45	12	35	Hyundai	HL940	3	16	55	12	35
Fiattalis	FR130	3	16	55	12	35	Hyundai	HL940 XT	3	16	55	12	35
Fiattalis	FR130-2	3	16	55	12	35	Hyundai	HL955	3.1	16	60	12	35
Fiattalis	FR140	3	16	55	12	35	Hyundai	HL955 XTD	3.1	16	60	12	35
Fiattalis	FR140-2	3.25	16	55	12	35	Hyundai	HL960	3.8	20	75	16	45
Fiattalis	FR15	3	16	55	12	35	Hyundai	HL960 XT	3.8	20	75	16	45
Fiattalis	FR15B	3.1	16	60	12	35	JCB	417HT	2	12	40	12	35
Fiat Hitachi	W170 PL	3.9	20	65	12	40	JCB	417HT HL	2	12	40	12	35
Furukawa	FL150-I	2	12	40	12	35	JCB	417HT SHL	2	12	45	12	35
Furukawa	FL200-I	2.6	12	50	12	35	JCB	426HT	2.5	12	50	12	35
Furukawa	FL230-I	3.1	16	60	12	35	JCB	426HT	2.75	16	55	12	35
Hitachi	ZW140-5	3	12	50	12	35	JCB	426ZX	2.5	12	50	12	35
Hitachi	ZW140-5 HL	2.1	12	45	12	35	JCB	426ZX	2.75	12	50	12	35
Hitachi	ZW140-6	2.7	12	50	12	35	JCB	436HT	3.5	16	60	12	35
Hitachi	ZW140-6 HL	2.7	12	55	12	35	JCB	436ZX	3.5	16	65	12	35
Hitachi	ZW150	3	12	55	12	35	JCB	456HT	4.6	CT	CT	20	55
Hitachi	ZW150 HL	2.6	12	50	12	35	Kawasaki	62Z7	2.75	12	50	12	35
Hitachi	ZW150-5	3.3	16	55	12	35	Kawasaki	62Z7 HL	2.75	12	50	12	35
Hitachi	ZW150-5 HL	2.6	12	50	12	35	Kawasaki	65ZV-2	3	12	50	12	35
Hitachi	ZW150-6	3.1	12	55	12	35	Kawasaki	65TMV-2	2.5	12	50	12	35
Hitachi	ZW150-6 HL	3.1	16	55	12	35	Kawasaki	67Z7	3.1	12	55	12	35
Hitachi	ZW150PL-6	2.7	12	50	12	35	Kawasaki	67Z7 HL	3.1	16	55	12	35
Hitachi	ZW180	3.6	16	60	12	35	Kawasaki	70Z	3	16	55	12	35
Hitachi	ZW180 HL	3.1	16	60	12	35	Kawasaki	70ZII	3	16	55	12	35
Hitachi	ZW180-5	3.7	16	65	12	35	Kawasaki	70ZIII	3.25	16	55	12	35

CONTINUES ON NEXT PAGE

20.5-25 LOADER USAGE CHART CONTINUED

For Standard Loader Service: <250 ft, < 5 mph

*This excludes HK 458, see pages 83-85 for HK 458 pressures



Manufacturer	Model	Bucket (cu. yd.)	Front Minimum Ply Rating	Front Minimum Inflation (psi)	Rear Minimum Ply Rating	Rear Minimum Inflation (psi)
Kawasaki	70ZIV	3.25	16	55	12	35
Kawasaki	70ZIV-2	3.5	16	60	12	35
Kawasaki	70ZV-2	3.5	16	55	12	35
Kawasaki	70TMV-2	3.4	20	65	12	40
Kawasaki	70Z7	3.7	16	65	12	35
Kawasaki	70Z7 HL	3.7	20	70	16	40
Kawasaki	80ZV-2	4.2	20	75	16	45
Komatsu	WA200-5	2.6	12	45	12	35
Komatsu	WA200-6	2.6	12	45	12	35
Komatsu	WA200PZ-6	2.5	12	50	12	35
Komatsu	WA200-7	2.6	12	50	12	35
Komatsu	WA200-8	2.6	12	50	12	35
Komatsu	WA250-1	3	12	50	12	35
Komatsu	WA250-3	3.5	16	55	12	35
Komatsu	WA250-3 PTC	3	16	55	12	35
Komatsu	WA250-5	3	12	50	12	35
Komatsu	WA250-6	3	12	50	12	35
Komatsu	WA250PZ-6	3	16	55	12	35
Komatsu	WA270-7	3	16	55	12	35
Komatsu	WA270-8	3	16	55	12	35
Komatsu	WA320-1	3.25	16	55	12	35
Komatsu	WA320-3	4.2	20	65	12	40
Komatsu	WA320-6	3.7	16	60	12	35
Komatsu	WA320PZ-6	3.5	20	65	12	40
Komatsu	WA320-7	3.7	20	65	12	40
Komatsu	WA320-8	3.7	20	65	16	40
Komatsu Dresser	520CH	2.5	12	45	12	35
Komatsu Dresser	525	2.7	12	50	12	35
Komatsu Dresser	530	3	16	55	12	35
Komatsu Dresser	530C	3	16	55	12	35
Komatsu Dresser	532	3.2	16	60	12	35
Liebherr	L538 Z-bar	3.4	16	55	12	35
Liebherr	L538	3	16	55	12	35
Liebherr	L538 HL	3	16	60	12	35
Liebherr	L542 Z-bar	3.7	16	65	12	35
Liebherr	L542	3.3	16	60	12	35
Liebherr	L542 HL	3.3	16	65	12	35
Liebherr	L546 Z-bar	3.6	16	60	12	35
Liebherr	L546	3.25	16	60	12	35
Liebherr	L546 HL	3.25	16	65	12	35
New Holland	W170B	3	16	55	12	35

Manufacturer	Model	Bucket (cu. yd.)	Front Minimum Ply Rating	Front Minimum Inflation (psi)	Rear Minimum Ply Rating	Rear Minimum Inflation (psi)
New Holland	W170B TC/LR	3	16	55	12	35
Terex	55C	3	16	55	12	35
Terex	TL210	4.6	20	70	16	45
Terex	TL260	5.9	CT	CT	20	55
Volvo	L60F	2.7	12	50	12	35
Volvo	L60G	2.75	12	50	12	35
Volvo	L60H	2.75	12	50	12	35
Volvo	L70B	2.1	12	45	12	35
Volvo	L70C	2.5	12	45	12	35
Volvo	L70D	2.5	12	45	12	35
Volvo	L70F	3	16	55	12	35
Volvo	L70G	3	16	55	12	35
Volvo	L70H	3	16	55	12	35
Volvo	L90B	3	16	55	12	35
Volvo	L90C	3.5	16	65	12	35
Volvo	L90D	3.5	20	65	12	40
Volvo	L90E	3.25	16	60	12	35
Volvo	L90F	3.5	20	65	12	40
Volvo	L90G	3.25	16	60	12	35
Volvo	L90H	3.25	16	60	12	35

For service under chains, or load and carry operations, contact Titan Technical Services.

Pressure and ply recommendations based on normal quarry operations with standard equipment. For different applications, or modified equipment, please contact OTR Field Engineering for a specific recommendation. Tire damage or failure caused by improper load, ply, speed or inflation practices is not covered by the Titan Tire Warranty Policy.

CT - Contact Titan Technical services
HL - High Lift, extended booms, etc.



TITAN HK 458 20.5-25 LOADER USAGE CHART

For Standard Loader Service: <250 ft, < 5 mph



Manufacturer	Model	Bucket (cu. yd.)	Front Minimum Ply Rating	Front Minimum Inflation (psi)	Rear Minimum Ply Rating	Rear Minimum Inflation (psi)	Manufacturer	Model	Bucket (cu. yd.)	Front Minimum Ply Rating	Front Minimum Inflation (psi)	Rear Minimum Ply Rating	Rear Minimum Inflation (psi)
Caterpillar	IT38F	3.25	20	40	20	35	Case	521G XR	2.3	20	35	20	35
Caterpillar	IT38G	2.75	20	40	20	35	Case	521G XT	2.1	20	35	20	35
Caterpillar	IT38G	3.5	20	40	20	35	Case	521G XT	2	20	35	20	35
Caterpillar	IT38H	3.3	20	45	20	35	Case	621B	2.25	20	35	20	35
Caterpillar	924G	2.3	20	35	20	35	Case	621B	3	20	35	20	35
Caterpillar	924H	2.4	20	35	20	35	Case	621B XT	2.25	20	40	20	35
Caterpillar	924HZ	2.3	20	35	20	35	Case	621D	2.5	20	35	20	35
Caterpillar	924K	2.5	20	55	20	35	Case	621E	3	20	40	20	35
Caterpillar	924K	3.3	20	45	20	35	Case	621E XT	3	20	40	20	35
Caterpillar	924K	4.6	20	50	20	35	Case	621E XR	3	20	40	20	35
Caterpillar	924K	6.5	20	55	20	35	Case	621G Z-Bar	2.5	20	35	20	35
Caterpillar	926M	4	20	45	20	35	Case	621G Z-Bar	2.4	20	35	20	35
Caterpillar	926M	6.5	20	55	20	35	Case	621G Z-Bar	2.75	20	40	20	35
Caterpillar	928HZ	2.6	20	35	20	35	Case	621G XR	2.5	20	40	20	35
Caterpillar	930H	2.7	20	40	20	35	Case	621G XR	2.4	20	35	20	35
Caterpillar	930K	2.75	20	55	20	35	Case	621G XR	2.75	20	40	20	35
Caterpillar	930K	3.5	20	45	20	35	Case	621G XT	2.5	20	40	20	35
Caterpillar	930K	4.6	20	50	20	35	Case	621G XT	2.4	20	40	20	35
Caterpillar	930K	6.5	20	55	20	35	Case	621G XT	3	20	40	20	35
Caterpillar	930M	2.75	20	55	20	35	Case	621G XT	2.8	20	40	20	35
Caterpillar	930M	3.5	20	45	20	35	Case	721	2.75	20	35	20	35
Caterpillar	930M	4	20	45	20	35	Case	721B	2.75	20	35	20	35
Caterpillar	930M	6.5	20	55	20	35	Case	721B XT	2.75	20	40	20	35
Caterpillar	930M HL	2.7	20	40	20	35	Case	721C	2.75	20	40	20	35
Caterpillar	936F TC	3	20	40	20	35	Case	721E	3.5	20	40	20	35
Caterpillar	938F	3.25	20	40	20	35	Case	721E XT	3	20	40	20	35
Caterpillar	938G	3.25	20	40	20	35	Case	721E XR	3	20	40	20	35
Caterpillar	938H	3.65	20	45	20	35	Case	721F	3	20	40	20	35
Caterpillar	938K	3.25	20	45	20	35	Case	721F XT	3	20	40	20	35
Caterpillar	938K	4.2	20	50	20	35	Case	721F XR	3	20	40	20	35
Caterpillar	938K	4.6	20	50	20	35	Case	721G Z-Bar	3	20	40	20	35
Caterpillar	938K	6.5	20	60	20	35	Case	721G Z-Bar	2.8	20	40	20	35
Caterpillar	938M	3.25	20	65	20	40	Case	721G Z-Bar	3.25	20	40	20	35
Caterpillar	938M	4	20	50	20	35	Case	721G XR	3	20	40	20	35
Caterpillar	938M	4.2	20	50	20	35	Case	721G XR	2.8	20	40	20	35
Caterpillar	938M	6.5	20	60	20	35	Case	721G XR	3.25	20	45	20	35
Caterpillar	938M HL	3.2	20	45	20	35	Case	721G XT	3	20	45	20	35
Caterpillar	950B	3.75	20	50	20	35	Case	721G XT	2.8	20	40	20	35
Caterpillar	950F	4	20	50	20	35	Case	W30	3.5	20	40	20	35
Case	521G Z-Bar	2.1	20	35	20	35	Daewoo	Mega 250-III	3.1	20	40	20	35
Case	521G Z-Bar	2	20	35	20	35	Deere	444K Z-bar	2.5	20	35	20	35
Case	521G Z-Bar	2.3	20	35	20	35	Deere	444K HL	2.5	20	35	20	35
Case	521G XR	2.1	20	35	20	35	Deere	444K Powerllel	2.5	20	40	20	35
Case	521G XR	2	20	35	20	35							

CONTINUES ON NEXT PAGE

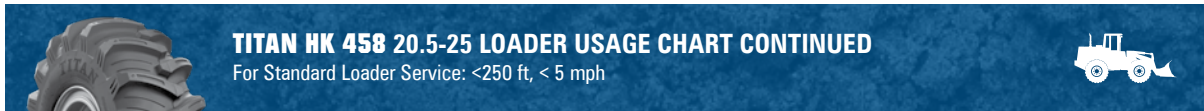

TITAN HK 458 20.5-25 LOADER USAGE CHART CONTINUED

For Standard Loader Service: <250 ft, < 5 mph

Manufacturer	Model	Bucket (cu. yd.)	Front Minimum Ply Rating	Front Minimum Inflation (psi)	Rear Minimum Ply Rating	Rear Minimum Inflation (psi)	Manufacturer	Model	Bucket (cu. yd.)	Front Minimum Ply Rating	Front Minimum Inflation (psi)	Rear Minimum Ply Rating	Rear Minimum Inflation (psi)
Deere	524K Z-bar	2.75	20	35	20	35	Furukawa	FL150-I	2	20	35	20	35
Deere	524K HL	2.75	20	40	20	35	Furukawa	FL200-I	2.6	20	35	20	35
Deere	524L	2.75	20	40	20	35	Furukawa	FL230-I	3.1	20	40	20	35
Deere	524L HL	2.75	20	40	20	35	Hitachi	ZW140-5	3	20	35	20	35
Deere	544H	3	20	40	20	35	Hitachi	ZW140-5 HL	2.1	20	35	20	35
Deere	544H-HL	3	20	40	20	35	Hitachi	ZW140-6	2.7	20	35	20	35
Deere	544J	3	20	40	20	35	Hitachi	ZW140-6 HL	2.7	20	40	20	35
Deere	544J-HL	3	20	40	20	35	Hitachi	ZW150	3	20	35	20	35
Deere	544K	3	20	40	20	35	Hitachi	ZW150 HL	2.6	20	40	20	35
Deere	544K-HL	3	20	40	20	35	Hitachi	ZW150-5	3.3	20	40	20	35
Deere	544L	3	20	40	20	35	Hitachi	ZW150-5 HL	2.6	20	35	20	35
Deere	544L HL	2.75	20	40	20	35	Hitachi	ZW150-6	3.1	20	40	20	35
Deere	624E	2.6	20	40	20	35	Hitachi	ZW150-6 HL	3.1	20	40	20	35
Deere	624G	3.25	20	40	20	35	Hitachi	ZW150PL-6	2.7	20	35	20	35
Deere	624H	3.5	20	40	20	35	Hitachi	ZW180	3.6	20	45	20	35
Deere	624H-HL	3	20	40	20	35	Hitachi	ZW180 HL	3.1	20	45	20	35
Deere	624K	3.5	20	45	20	35	Hitachi	ZW180-5	3.7	20	45	20	35
Deere	624K-HL	3.5	20	45	20	35	Hitachi	ZW180-5 HL	3.1	20	45	20	35
Deere	624L	3.5	20	45	20	35	Hitachi	ZW180-6	3.7	20	45	20	35
Deere	624L HL	3.5	20	45	20	35	Hitachi	ZW180-6 HL	3.7	20	45	20	35
Deere	644B	2.5	20	35	20	35	Hyundai	HL25	3.5	20	50	20	35
Deere	644C	3	20	40	20	35	Hyundai	HL740-7A	2.7	20	35	20	35
Doosan	DL200	2.6	20	35	20	35	Hyundai	HL740XTD-7A	2.7	20	35	20	35
Doosan	DL200TC	2.6	20	35	20	35	Hyundai	HL740TM-7A	2.6	20	35	20	35
Doosan	DL200-5	2.6	20	35	20	35	Hyundai	HL740-9A	3	20	40	20	35
Doosan	DL200-5 HL	2.6	20	35	20	35	Hyundai	HL740XTD-9A	3	20	40	20	35
Doosan	DL200TC-5	2.6	20	35	20	35	Hyundai	HL740TM-9A	3	20	40	20	35
Doosan	DL220-5	3	20	40	20	35	Hyundai	HL750	3	20	40	20	35
Doosan	DL220-5 HL	3	20	40	20	35	Hyundai	HL757-7A	2.7	20	40	20	35
Doosan	DL250	3.3	20	40	20	35	Hyundai	HL757XTD-7A	2.7	20	40	20	35
Doosan	DL250TC	3.4	20	45	20	35	Hyundai	HL757TM-7A	2.5	20	40	20	35
Doosan	DL250HL	3.4	20	45	20	35	Hyundai	HL757-9A	3.7	20	45	20	35
Doosan	DL250-5	3.3	20	40	20	35	Hyundai	HL757XTD-9A	3.7	20	45	20	35
Doosan	DL250-5 HL	3.3	20	40	20	35	Hyundai	HL757TM-9A	3.5	20	45	20	35
Doosan	DL250TC-5	3.3	20	45	20	35	Hyundai	HL760-9A	4.3	20	50	20	35
Doosan	DL280-5	3.7	20	45	20	35	Hyundai	HL760XTD-9A	4.3	20	55	20	35
Doosan	DL280-5 HL	3.7	20	45	20	35	Hyundai	HL940	3	20	40	20	35
Dressta	520E	2.3	20	35	20	35	Hyundai	HL940 XT	3	20	40	20	35
Fiatallis	FR130	3	20	40	20	35	Hyundai	HL955	3.1	20	45	20	35
Fiatallis	FR130-2	3	20	40	20	35	Hyundai	HL955 XTD	3.1	20	45	20	35
Fiatallis	FR140	3	20	40	20	35	Hyundai	HL960	3.8	20	50	20	35
Fiatallis	FR140-2	3.25	20	40	20	35	Hyundai	HL960 XT	3.8	20	50	20	35
Fiatallis	FR15	3	20	40	20	35	JCB	417HT	2	20	35	20	35
Fiatallis	FR15B	3.1	20	45	20	35	JCB	417HT HL	2	20	35	20	35
Fiat Hitachi	W170 PL	3.9	20	45	20	35	JCB	417HT SHL	2	20	35	20	35

CONTINUES ON NEXT PAGE

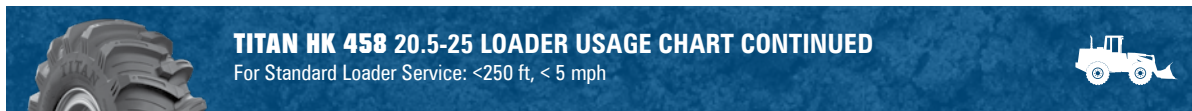

TITAN HK 458 20.5-25 LOADER USAGE CHART CONTINUED

For Standard Loader Service: <250 ft, < 5 mph

Manufacturer	Model	Bucket (cu. yd.)	Front Minimum Ply Rating	Front Minimum Inflation (psi)	Rear Minimum Ply Rating	Rear Minimum Inflation (psi)
JCB	426HT	2.5	20	35	20	35
JCB	426HT	2.75	20	40	20	35
JCB	426ZX	2.5	20	35	20	35
JCB	426ZX	2.75	20	40	20	35
JCB	436HT	3.5	20	40	20	35
JCB	436ZX	3.5	20	45	20	35
JCB	456HT	4.6	20	60	20	35
Kawasaki	62Z7	2.75	20	35	20	35
Kawasaki	62Z7 HL	2.75	20	35	20	35
Kawasaki	65ZV-2	3	20	35	20	35
Kawasaki	65TMV-2	2.5	20	35	20	35
Kawasaki	67Z7	3.1	20	40	20	35
Kawasaki	67Z7 HL	3.1	20	40	20	35
Kawasaki	70Z	3	20	40	20	35
Kawasaki	70ZII	3	20	40	20	35
Kawasaki	70ZIII	3.25	20	40	20	35
Kawasaki	70ZIV	3.25	20	40	20	35
Kawasaki	70ZIV-2	3.5	20	40	20	35
Kawasaki	70ZV-2	3.5	20	40	20	35
Kawasaki	70TMV-2	3.4	20	45	20	35
Kawasaki	70Z7	3.7	20	45	20	35
Kawasaki	70Z7 HL	3.7	20	45	20	35
Kawasaki	80ZV-2	4.2	20	50	20	35
Komatsu	WA200-5	2.6	20	35	20	35
Komatsu	WA200-6	2.6	20	35	20	35
Komatsu	WA200PZ-6	2.5	20	35	20	35
Komatsu	WA200-7	2.6	20	35	20	35
Komatsu	WA200-8	2.6	20	35	20	35
Komatsu	WA250-1	3	20	35	20	35
Komatsu	WA250-3	3.5	20	35	20	35
Komatsu	WA250-3 PTC	3	20	35	20	35
Komatsu	WA250-5	3	20	35	20	35
Komatsu	WA250-6	3	20	35	20	35
Komatsu	WA250PZ-6	3	20	40	20	35
Komatsu	WA270-7	3	20	40	20	35
Komatsu	WA270-8	3	20	40	20	35
Komatsu	WA320-1	3.25	20	40	20	35
Komatsu	WA320-3	4.2	20	45	20	35
Komatsu	WA320-6	3.7	20	45	20	35
Komatsu	WA320PZ-6	3.5	20	45	20	35
Komatsu	WA320-7	3.7	20	45	20	35
Komatsu	WA320-8	3.7	20	45	20	35
Komatsu Dresser	520CH	2.5	20	35	20	35
Komatsu Dresser	525	2.7	20	35	20	35

Manufacturer	Model	Bucket (cu. yd.)	Front Minimum Ply Rating	Front Minimum Inflation (psi)	Rear Minimum Ply Rating	Rear Minimum Inflation (psi)
Komatsu Dresser	530	3	20	40	20	35
Komatsu Dresser	530C	3	20	40	20	35
Komatsu Dresser	532	3.2	20	40	20	35
Liebherr	L538 Z-bar	3.4	20	40	20	35
Liebherr	L538	3	20	40	20	35
Liebherr	L538 HL	3	20	40	20	35
Liebherr	L542 Z-bar	3.7	20	45	20	35
Liebherr	L542	3.3	20	40	20	35
Liebherr	L542 HL	3.3	20	45	20	35
Liebherr	L546 Z-bar	3.6	20	45	20	35
Liebherr	L546	3.25	20	40	20	35
Liebherr	L546 HL	3.25	20	45	20	35
New Holland	W170B	3	20	40	20	35
New Holland	W170B TC/LR	3	20	40	20	35
Terex	55C	3	20	40	20	35
Terex	TL210	4.6	20	45	20	35
Terex	TL260	5.9	20	50	20	35
Volvo	L60F	2.7	20	35	20	35
Volvo	L60G	2.75	20	35	20	35
Volvo	L60H	2.75	20	35	20	35
Volvo	L70B	2.1	20	35	20	35
Volvo	L70C	2.5	20	35	20	35
Volvo	L70D	2.5	20	35	20	35
Volvo	L70F	3	20	40	20	35
Volvo	L70G	3	20	40	20	35
Volvo	L70H	3	20	40	20	35
Volvo	L90B	3	20	40	20	35
Volvo	L90C	3.5	20	45	20	35
Volvo	L90D	3.5	20	45	20	35
Volvo	L90E	3.25	20	45	20	35
Volvo	L90F	3.5	20	45	20	35
Volvo	L90G	3.25	20	45	20	35
Volvo	L90H	3.25	20	45	20	35

For service under chains, or load and carry operations, contact Titan Technical Services.

Pressure and ply recommendations based on normal quarry operations with standard equipment. For different applications, or modified equipment, please contact OTR Field Engineering for a specific recommendation. Tire damage or failure caused by improper load, ply, speed or inflation practices is not covered by the Titan Tire Warranty Policy.

CT - Contact Titan Technical services
HL - High Lift, extended booms, etc.

23.5-25 LOADER USAGE CHART

For Standard Loader Service: <250 ft, < 5 mph

*This excludes HK 458, see pages 88-89 for HK 458 pressures



Manufacturer	Model	Bucket (cu. yd.)	Front Minimum Ply Rating	Front Minimum Inflation (psi)	Rear Minimum Ply Rating	Rear Minimum Inflation (psi)	Manufacturer	Model	Bucket (cu. yd.)	Front Minimum Ply Rating	Front Minimum Inflation (psi)	Rear Minimum Ply Rating	Rear Minimum Inflation (psi)
Caterpillar	924K	2.5	12	45	12	35	Case	921G Z-Bar	3.8	20	65	16	40
Caterpillar	926M	2.5	12	45	12	35	Case	921G Z-Bar	4	20	60	16	35
Caterpillar	930K	2.75	12	45	12	35	Case	921G Z-Bar	4.6	20	65	16	35
Caterpillar	930M	2.75	12	45	12	35	Case	W36	4	16	55	12	35
Caterpillar	938K	3.25	16	50	12	35	Daewoo	Mega 300	3.8	16	55	12	35
Caterpillar	938M	3.25	16	55	12	35	Daewoo	Mega 300-III	2.9	12	50	12	35
Caterpillar	950F TC	4	16	60	12	35	Deere	644D	3.2	12	50	12	35
Caterpillar	950E	4	16	60	12	35	Deere	644E	3.2	12	50	12	35
Caterpillar	950F-II	4	20	60	12	35	Deere	644G	4	16	55	12	35
Caterpillar	950G	3.9	16	60	12	35	Deere	644H	4.25	16	55	12	35
Caterpillar	950GC	4	20	60	12	35	Deere	644H-HL	4.25	20	60	12	35
Caterpillar	950G -II	2.7	12	50	12	35	Deere	644H-MH	4.5	20	60	12	35
Caterpillar	950H	4	20	60	12	35	Deere	644H-WH	6	24	75	16	45
Caterpillar	950K	3.5	16	55	12	35	Deere	644K	4.25	20	60	12	35
Caterpillar	950L	7.5	16	60	12	35	Deere	644K-HL	4.25	20	65	16	35
Caterpillar	950M	4.5	20	65	16	40	Deere	644K-WH	5	24	70	16	45
Caterpillar	960F	4.5	20	65	16	40	Deere	724J	4.75	20	65	16	35
Caterpillar	962G	4.25	20	65	16	35	Deere	724J-HL	4.25	20	60	16	35
Caterpillar	962H	4.5	20	65	16	40	Deere	724K	4.75	20	65	16	35
Caterpillar	962K	3.5	16	60	12	35	Deere	724K-HL	4.25	20	65	16	35
Caterpillar	962L	3.9	20	60	12	35	Doosan	DL300	4.2	16	60	12	35
Caterpillar	962M	4.7	24	70	16	40	Doosan	DL300-5	4.2	20	60	12	35
Caterpillar	966C	4	20	60	12	35	Doosan	DL300-5 HL	4.2	20	65	16	40
Caterpillar	966D	4.25	20	65	16	40	Doosan	DL350-5	4.8	20	65	16	40
Caterpillar	966F	5	24	70	16	45	Doosan	DL350-5 HL	4.8	24	70	16	45
Caterpillar	IT62H	4.25	20	65	16	35	Fiatallis	FR160	3.6	16	50	12	35
Case	821	3.5	12	50	12	35	Fiatallis	FR160-2	4	16	55	12	35
Case	821B	3.5	16	50	12	35	Fiatallis	FR180	4	16	55	12	35
Case	821C	3.5	16	55	12	35	Fiatallis	FR180-2	4	16	55	12	35
Case	821E	4.5	20	60	12	35	Fiatallis	FR20	4.5	20	65	16	35
Case	821E XR	4.5	20	65	16	35	Fiatallis	FR20B	4.6	20	65	16	40
Case	821F	3.5	16	55	12	35	Fiat Hitachi	W190	3.3	12	50	12	35
Case	821F XR	3.5	16	55	12	35	Fiat Hitachi	W230	4.6	20	65	16	35
Case	821G XR	3.2	20	60	12	35	Fiat Hitachi	FR160-2	4	16	55	12	35
Case	821G XR	3.5	16	55	12	35	Hitachi	ZW180-6	3.7	16	50	12	35
Case	821G XR	4.25	20	65	16	35	Hitachi	ZW180-6 HL	3.7	16	55	12	35
Case	821G Z-Bar	3.2	16	50	12	35	Hitachi	ZW220	4.2	16	60	12	35
Case	821G Z-Bar	3.5	16	55	12	35	Hitachi	ZW220 HL	3.5	16	55	12	35
Case	821G Z-Bar	4.25	20	60	12	35	Hitachi	ZW220-5	4.5	20	60	12	35
Case	921F	4.75	20	65	16	35	Hitachi	ZW220-5 HL	3.5	16	55	12	35
Case	921F XR	4.75	24	70	16	40	Hitachi	ZW220-6	4.2	16	60	12	35
Case	921G XR	3.8	20	60	16	35	Hitachi	ZW220-6 HL	4.2	20	60	12	35
Case	921G XR	4	20	65	16	40	Hitachi	ZW250	4.5	20	65	16	35
Case	921G XR	4.6	24	70	16	40	Hitachi	ZW250 HL	4	20	65	16	35

CONTINUES ON NEXT PAGE

23.5-25 LOADER USAGE CHART CONTINUED

For Standard Loader Service: <250 ft, < 5 mph

*This excludes HK 458, see pages 88-89 for HK 458 pressures



Manufacturer	Model	Bucket (cu. yd.)	Front Minimum Ply Rating	Front Minimum Inflation (psi)	Rear Minimum Ply Rating	Rear Minimum Inflation (psi)
Hitachi	ZW250-5	5.2	24	70	16	40
Hitachi	ZW250-5 HL	4	20	65	16	35
Hitachi	ZW250-6	4.8	24	65	16	40
Hitachi	ZW250-6 HL	4.8	24	70	16	45
Hyundai	HL35	4.8	24	70	16	40
Hyundai	HL760	4	20	60	12	35
Hyundai	HL760-7A	4	16	60	12	35
Hyundai	HL760-XTD-7A	4	20	60	12	35
Hyundai	HL760-9	4.3	20	60	12	35
Hyundai	HL760XTD-9	4.3	20	65	16	35
Hyundai	HL760-9A	4.3	20	60	12	35
Hyundai	HL760XTD-9A	4.3	20	65	16	35
Hyundai	HL770-7	5.2	24	75	20	45
Hyundai	HL770-XTD-7	5.2	CT	CT	20	45
Hyundai	HL770-7A	4	20	65	16	35
Hyundai	HL770-XTD-7A	4	24	70	16	40
Hyundai	HL770-9	5.5	24	75	20	45
Hyundai	HL770XTD-9	5.5	CT	CT	20	50
Hyundai	HL770-9A	5.5	24	80	20	45
Hyundai	HL770XTD-9A	5.5	CT	CT	20	50
Hyundai	HL960	3.8	16	60	12	35
Hyundai	HL960 XT	3.8	16	60	12	35
Hyundai	HL970	4.7	24	70	16	40
Hyundai	HL970 XTD	4.7	24	75	20	45
JCB	456ZX	4.3	20	60	16	35
JCB	457HT	4.1	20	60	12	35
JCB	457HT SHL	4.1	24	70	16	45
JCB	457ZX	4.1	20	60	12	35
JCB	457ZX HL	4.1	20	65	16	40
Kawasaki	70ZV-2	3.5	16	50	12	35
Kawasaki	70ZV-2 HL	3.5	16	55	12	35
Kawasaki	70TMV-2	3.4	16	55	12	35
Kawasaki	70Z7	3.7	16	50	12	35
Kawasaki	70Z7 HL	3.7	16	55	12	35
Kawasaki	80Z	3.75	16	55	12	35
Kawasaki	80ZII	3.75	16	55	12	35
Kawasaki	80ZIII	3.75	16	55	12	35
Kawasaki	80ZIV	3.75	16	55	12	35
Kawasaki	80ZIV-2	4	16	55	12	35
Kawasaki	80ZV-2	4.2	20	60	12	35
Kawasaki	80Z7	4.2	16	60	12	35
Kawasaki	80Z7 HL	4.2	20	60	12	35
Kawasaki	85Z7	4.8	20	65	16	40
Kawasaki	85Z7 HL	4.8	24	70	16	45
Kawasaki	90Z7	5.5	CT	CT	20	50
Kawasaki	90Z7 HL	5.5	CT	CT	20	50

Manufacturer	Model	Bucket (cu. yd.)	Front Minimum Ply Rating	Front Minimum Inflation (psi)	Rear Minimum Ply Rating	Rear Minimum Inflation (psi)
Kawasaki	90Z7B	5.5	CT	CT	20	45
Kawasaki	90Z7B HL	5.5	CT	CT	20	50
Komatsu	WA380-3	5.25	20	65	16	40
Komatsu	WA380-6	4.3	16	60	12	35
Komatsu	WA380-7	4.3	20	60	12	35
Komatsu	WA380-7 HL	3.8	16	55	12	35
Komatsu	WA380-8	4.3	20	60	12	35
Komatsu	WA380-8 HL	3.8	20	60	12	35
Komatsu	WA430-6	4.6	20	65	16	35
Komatsu Dresser	538	4	20	60	12	35
Komatsu Dresser	540	4.5	20	60	12	35
Liebherr	L550	4.2	16	60	12	35
Liebherr	L550 HL	3.4	16	55	12	35
Liebherr	L550XP	4.2	20	60	12	35
Liebherr	L550XP HL	3.4	16	60	12	35
Liebherr	L556	4.7	20	60	12	35
Liebherr	L556 HL	3.7	20	60	12	35
Liebherr	L556XP	4.7	20	65	16	40
Liebherr	L556XP HL	3.7	20	60	12	35
New Holland	W190B	3.44	16	50	12	35
New Holland	W190B LR	3.44	16	55	12	35
Terex	66C	4	20	60	16	35
Terex	70C	4.4	20	60	16	35
Terex	TL310	4	16	60	12	35
Volvo	L110F	4.4	20	65	16	35
Volvo	L110G	4.5	20	65	16	35
Volvo	L110H	4	16	60	12	35
Volvo	L120B	3.9	16	55	12	35
Volvo	L120C	4.7	20	65	16	35
Volvo	L120D	4.7	20	65	16	40
Volvo	L120F	4.7	24	65	16	40
Volvo	L120G	4.5	20	65	16	35
Volvo	L120H	4.25	20	60	12	35
Volvo	L150	4.5	24	70	16	40
Volvo	L150C	5.2	24	70	16	45
Volvo	L150D	5.2	24	75	20	45

For service under chains, or load and carry operations, contact Titan Technical Services.

Pressure and ply recommendations based on normal quarry operations with standard equipment. For different applications, or modified equipment, please contact OTR Field Engineering for a specific recommendation. Tire damage or failure caused by improper load, ply, speed or inflation practices is not covered by the Titan Tire Warranty Policy.

CT - Contact Titan Technical services
HL - High Lift, extended booms, etc.



TITAN HK 458 23.5-25 LOADER USAGE CHART

For Standard Loader Service: <250 ft, < 5 mph



Manufacturer	Model	Bucket (cu. yd.)	Front Minimum Ply Rating	Front Minimum Inflation (psi)	Rear Minimum Ply Rating	Rear Minimum Inflation (psi)
Caterpillar	924K	2.5	20	35	20	35
Caterpillar	926M	2.5	20	35	20	35
Caterpillar	930K	2.75	20	35	20	35
Caterpillar	930M	2.75	20	35	20	35
Caterpillar	938K	3.25	20	40	20	35
Caterpillar	938M	3.25	20	40	20	35
Caterpillar	950F TC	4	20	40	20	35
Caterpillar	950E	4	20	40	20	35
Caterpillar	950F-II	4	20	40	20	35
Caterpillar	950G	3.9	20	45	20	35
Caterpillar	950GC	4	20	45	20	35
Caterpillar	950G -II	2.7	20	35	20	35
Caterpillar	950H	4	20	40	20	35
Caterpillar	950K	3.5	20	40	20	35
Caterpillar	950M	4.5	20	45	20	35
Caterpillar	960F	4.5	20	45	20	35
Caterpillar	962G	4.25	20	45	20	35
Caterpillar	962H	4.5	20	45	20	35
Caterpillar	962K	3.5	20	45	20	35
Caterpillar	962M	4.7	20	45	20	35
Caterpillar	966C	4.0	20	45	20	35
Caterpillar	966D	4.25	20	45	20	35
Caterpillar	966F	5	20	50	20	35
Caterpillar	IT62H	4.25	20	45	20	35
Case	821	3.5	20	35	20	35
Case	821B	3.5	20	40	20	35
Case	821C	3.5	20	40	20	35
Case	821E	4.5	20	40	20	35
Case	821E XR	4.5	20	45	20	35
Case	821F	3.5	20	40	20	35
Case	821F XR	3.5	20	40	20	35
Case	821G XR	3.2	20	45	20	35
Case	821G XR	3.5	20	40	20	35
Case	821G XR	4.25	20	45	20	35
Case	821G Z-Bar	3.2	20	40	20	35
Case	821G Z-Bar	3.5	20	40	20	35
Case	821G Z-Bar	4.25	20	40	20	35
Case	921F	4.75	20	45	20	35
Case	921F XR	4.75	20	45	20	35
Case	921G XR	3.8	20	45	20	35
Case	921G XR	4	20	45	20	35
Case	921G XR	4.6	20	45	20	35
Case	921G Z-Bar	3.8	20	45	20	35
Case	921G Z-Bar	4	20	45	20	35
Case	921G Z-Bar	4.6	20	45	20	35

Manufacturer	Model	Bucket (cu. yd.)	Front Minimum Ply Rating	Front Minimum Inflation (psi)	Rear Minimum Ply Rating	Rear Minimum Inflation (psi)
Case	W36	4	20	40	20	35
Deere	644D	3.2	20	35	20	35
Deere	644E	3.2	20	35	20	35
Deere	644G	4	20	40	20	35
Deere	644H	4.25	20	40	20	35
Deere	644H-HL	4.25	20	40	20	35
Deere	644H-MH	4.5	20	40	20	35
Deere	644H-WH	6	20	45	20	35
Deere	644K	4.25	20	40	20	35
Deere	644K-HL	4.25	20	45	20	35
Deere	644K-WH	5	20	50	20	35
Deere	724J	4.75	20	45	20	35
Deere	724J-HL	4.25	20	45	20	35
Deere	724K	4.75	20	45	20	35
Deere	724K-HL	4.25	20	45	20	35
Hitachi	ZW180-6	3.7	20	40	20	35
Hitachi	ZW180-6 HL	3.7	20	40	20	35
Hitachi	ZW220	4.2	20	40	20	35
Hitachi	ZW220 HL	3.5	20	40	20	35
Hitachi	ZW220-5	4.5	20	45	20	35
Hitachi	ZW220-5 HL	3.5	20	40	20	35
Hitachi	ZW220-6	4.2	20	40	20	35
Hitachi	ZW220-6 HL	4.2	20	45	20	35
Hitachi	ZW250	4.5	20	45	20	35
Hitachi	ZW250 HL	4	20	45	20	35
Hitachi	ZW250-5	5.2	20	45	20	35
Hitachi	ZW250-5 HL	4	20	45	20	35
Hitachi	ZW250-6	4.8	20	45	20	35
Hitachi	ZW250-6 HL	4.8	20	50	20	35
Hyundai	HL35	4.8	20	50	20	35
Hyundai	HL760	4	20	45	20	35
Hyundai	HL760-7A	4	20	40	20	35
Hyundai	HL760-XTD-7A	4	20	45	20	35
Hyundai	HL760-9	4.3	20	40	20	35
Hyundai	HL760XTD-9	4.3	20	45	20	35
Hyundai	HL760-9A	4.3	20	45	20	35
Hyundai	HL760XTD-9A	4.3	20	45	20	35
Hyundai	HL770-7	5.2	20	50	20	35
Hyundai	HL770-XTD-7	5.2	20	50	20	35
Hyundai	HL770-7A	4	20	45	20	35
Hyundai	HL770-XTD-7A	4	20	50	20	35
Hyundai	HL770-9	5.5	20	50	20	35
Hyundai	HL770XTD-9	5.5	20	55	20	35
Hyundai	HL770-9A	5.5	20	50	20	35
Hyundai	HL770XTD-9A	5.5	20	55	20	35

CONTINUES ON NEXT PAGE



TITAN HK 458 23.5-25 LOADER USAGE CHART CONTINUED

For Standard Loader Service: <250 ft, < 5 mph

Manufacturer	Model	Bucket (cu. yd.)	Front Minimum Ply Rating	Front Minimum Inflation (psi)	Rear Minimum Ply Rating	Rear Minimum Inflation (psi)
Hyundai	HL960	3.8	20	40	20	35
Hyundai	HL960 XT	3.8	20	40	20	35
Hyundai	HL970	4.7	20	50	20	35
Hyundai	HL970 XTD	4.7	20	50	20	35
JCB	456ZX	4.3	20	45	20	35
JCB	457HT	4.1	20	45	20	35
JCB	457HT SHL	4.1	20	50	20	35
JCB	457ZX	4.1	20	45	20	35
JCB	457ZX HL	4.1	20	45	20	35
Kawasaki	70ZV-2	3.5	20	35	20	35
Kawasaki	70ZV-2 HL	3.5	20	40	20	35
Kawasaki	70TMV-2	3.4	20	40	20	35
Kawasaki	70Z7	3.7	20	35	20	35
Kawasaki	70Z7 HL	3.7	20	40	20	35
Kawasaki	80Z	3.75	20	40	20	35
Kawasaki	80ZII	3.75	20	40	20	35
Kawasaki	80ZIII	3.75	20	40	20	35
Kawasaki	80ZIV	3.75	20	40	20	35
Kawasaki	80ZIV-2	4	20	40	20	35
Kawasaki	80ZV-2	4.2	20	40	20	35
Kawasaki	80Z7	4.2	20	40	20	35
Kawasaki	80Z7 HL	4.2	20	45	20	35
Kawasaki	85Z7	4.8	20	45	20	35
Kawasaki	85Z7 HL	4.8	20	50	20	35
Kawasaki	90Z7	5.5	20	55	20	35
Kawasaki	90Z7 HL	5.5	20	55	20	35
Kawasaki	90Z7B	5.5	20	55	20	35
Kawasaki	90Z7B HL	5.5	20	55	20	35
Komatsu	WA380-3	5.25	20	45	20	35
Komatsu	WA380-6	4.3	20	40	20	35
Komatsu	WA380-7	4.3	20	40	20	35
Komatsu	WA380-7 HL	3.8	20	40	20	35
Komatsu	WA380-8	4.3	20	40	20	35
Komatsu	WA380-8 HL	3.8	20	45	20	35
Komatsu	WA430-6	4.6	20	45	20	35
Komatsu Dresser	538	4	20	45	20	35
Komatsu Dresser	540	4.5	20	45	20	35
Liebherr	L550	4.2	20	40	20	35
Liebherr	L550 HL	3.4	20	40	20	35
Liebherr	L550XP	4.2	20	40	20	35
Liebherr	L550XP HL	3.4	20	40	20	35
Liebherr	L556	4.7	20	45	20	35
Liebherr	L556 HL	3.7	20	45	20	35
Liebherr	L556XP	4.7	20	45	20	35

Manufacturer	Model	Bucket (cu. yd.)	Front Minimum Ply Rating	Front Minimum Inflation (psi)	Rear Minimum Ply Rating	Rear Minimum Inflation (psi)
Liebherr	L556XP HL	3.7	20	45	20	35
New Holland	W190B	3.44	20	40	20	35
New Holland	W190B LR	3.44	20	40	20	35
Terex	66C	4	20	45	20	35
Terex	70C	4.4	20	45	20	35
Terex	TL310	4	20	40	20	35
Volvo	L110F	4.4	20	45	20	35
Volvo	L110G	4.5	20	45	20	35
Volvo	L110H	4	20	40	20	35
Volvo	L120B	3.9	20	40	20	35
Volvo	L120C	4.7	20	45	20	35
Volvo	L120D	4.7	20	45	20	35
Volvo	L120F	4.7	20	45	20	35
Volvo	L120G	4.5	20	45	20	35
Volvo	L120H	4.25	20	45	20	35
Volvo	L150	4.5	20	50	20	35
Volvo	L150C	5.2	20	50	20	35
Volvo	L150D	5.2	20	55	20	35

For service under chains, or load and carry operations, contact Titan Technical Services.

Pressure and ply recommendations based on normal quarry operations with standard equipment. For different applications, or modified equipment, please contact OTR Field Engineering for a specific recommendation. Tire damage or failure caused by improper load, ply, speed or inflation practices is not covered by the Titan Tire Warranty Policy.

CT - Contact Titan Technical services
HL - High Lift, extended booms, etc.

26.5-25 LOADER USAGE CHART

For Standard Loader Service: <250 ft, < 5 mph



Manufacturer	Model	Bucket (cu. yd.)	Front Minimum Ply Rating	Front Minimum Inflation (psi)	Rear Minimum Ply Rating	Rear Minimum Inflation (psi)	Manufacturer	Model	Bucket (cu. yd.)	Front Minimum Ply Rating	Front Minimum Inflation (psi)	Rear Minimum Ply Rating	Rear Minimum Inflation (psi)
Caterpillar	966E	5	20	60	20	35	Deere	744H-MH	5.75	20	70	20	40
Caterpillar	966F	5	20	60	20	35	Deere	744J	5.25	20	65	20	40
Caterpillar	966F-II	5	20	60	20	35	Deere	744J HL	5.25	26	70	20	40
Caterpillar	966G	4.75	20	65	20	35	Deere	744K	5.25	20	65	20	35
Caterpillar	966H	5.5	20	65	20	40	Deere	744K-HL	5.25	20	70	20	40
Caterpillar	966H	5.75	20	65	20	40	Deere	744K-II	5.25	20	65	20	40
Caterpillar	966K	5.5	20	70	20	40	Deere	744K-II HL	5.25	26	70	20	40
Caterpillar	966L	5.5	20	65	20	40	Deere	744L	5.25	20	65	20	40
Caterpillar	966M	5.5	20	65	20	40	Deere	744L HL	5.25	26	70	20	40
Caterpillar	966M XE	5.5	20	65	20	40	Deere	824J	6	26	75	20	45
Caterpillar	970F	5.25	20	65	20	40	Deere	824J HL	5.25	26	70	20	45
Caterpillar	972G	5.4	20	65	20	40	Deere	824K	6	26	70	20	45
Caterpillar	972H	6	26	70	20	40	Deere	824K-HL	6	26	75	20	45
Caterpillar	972K	5.5	20	70	20	40	Deere	824K-II	6	26	75	20	45
Caterpillar	972L	5.5	20	70	20	40	Deere	824K-II HL	6	26	75	20	45
Caterpillar	972M	6	20	65	20	40	Deere	824L	6	26	75	20	45
Caterpillar	972M XE	6	26	70	20	40	Deere	824L HL	6	32	80	20	50
Case	921	4.75	20	60	20	35	Deere	844	6	26	70	20	40
Case	921B	4.75	20	60	20	35	Doosan	DL400	5.1	20	60	20	35
Case	921C	4.75	20	60	20	35	Doosan	DL420-5	5.5	20	65	20	35
Case	921E	5.75	20	65	20	35	Doosan	DL420-5 HL	5.5	26	70	20	40
Case	921E XR	5.75	26	70	20	40	Doosan	DL450	6.3	26	75	20	45
Case	921F	4.75	20	55	20	35	Doosan	DL450-3	5.88	26	70	20	40
Case	921F XR	4.75	20	60	20	35	Doosan	DL450-5	6.3	26	75	20	45
Case	1021G Z-Bar	4.75	20	65	20	35	Doosan	DL450-5 HL	6.3	26	75	20	45
Case	1021G Z-Bar	4.6	20	60	20	35	Fiatallis	FR220	5.1	20	60	20	35
Case	1021G Z-Bar	5.5	20	70	20	40	Fiatallis	FR220-2	5	20	60	20	35
Case	1021G XR	4.75	20	65	20	40	Fiat Hitachi	W270	5.2	20	60	20	35
Case	1021G XR	4.6	20	65	20	40	Fiat Hitachi	FR220-2	5	20	60	20	35
Case	1021G XR	5.5	26	75	20	45	Furukawa	FL330-I	4.3	20	55	20	35
Case	1121F Z-bar	5.25	20	65	20	40	Hitachi	ZW250-6	4.8	20	60	20	35
Case	1121F Z-bar	6.25	26	75	20	45	Hitachi	ZW250-6 HL	4.8	20	60	20	35
Case	1121F XR	5.25	26	70	20	40	Hitachi	ZW310	5.25	20	60	20	35
Case	1121F XR	6.25	32	80	20	50	Hitachi	ZW310 HL	4.75	20	60	20	35
Case	1121G Z-Bar	5.25	26	70	20	40	Hitachi	ZW310-5	5.9	26	70	20	40
Case	1121G Z-Bar	5.1	20	70	20	40	Hitachi	ZW310-5 HL	5.25	20	70	20	40
Case	1121G Z-Bar	6.25	26	75	20	45	Hitachi	ZW310-6	5.5	20	65	20	40
Case	1121G XR	5.25	26	70	20	45	Hitachi	ZW310-6 HL	5.5	26	70	20	40
Case	1121G XR	5.1	26	70	20	40	Hitachi	ZW330-5	6.5	26	75	20	45
Case	1121G XR	6.25	32	80	20	50	Hitachi	ZW330-5 HL	6	26	75	20	45
Daewoo	Mega 400	5.1	20	60	20	35	Hyundai	HL770	5	20	65	20	35
Daewoo	Mega 400-III	3.9	20	55	20	35	Hyundai	HL770-7	5.2	20	65	20	35
Deere	744E	5	20	60	20	35	Hyundai	HL770XTD-7	5.2	20	65	20	40
Deere	744H	5.25	20	60	20	35	Hyundai	HL770-7A	5.2	20	65	20	35
Deere	744H-HL	4.5	20	60	20	35	Hyundai	HL770XTD-7A	5.2	20	65	20	40

CONTINUES ON NEXT PAGE

26.5-25 LOADER USAGE CHART CONTINUED

For Standard Loader Service: <250 ft, < 5 mph



Manufacturer	Model	Bucket (cu. yd.)	Front Minimum Ply Rating	Front Minimum Inflation (psi)	Rear Minimum Ply Rating	Rear Minimum Inflation (psi)
Hyundai	HL770-9	5.5	20	65	20	40
Hyundai	HL770XTD-9	5.5	20	70	20	40
Hyundai	HL770-9A	5.5	20	65	20	40
Hyundai	HL770XTD-9A	5.5	26	70	20	40
Hyundai	HL780-7A	6.7	32	80	20	50
Hyundai	HL780XTD-7A	6.7	32	85	20	50
Hyundai	HL780-9	7.1	32	85	20	50
Hyundai	HL780XTD-9	7.1	32	85	26	55
Hyundai	HL780-9A	7.1	32	85	20	50
Hyundai	HL780XTD-9A	7.1	32	90	26	55
Hyundai	HL970	4.7	20	60	20	35
Hyundai	HL970 XTD	4.7	20	65	20	35
Hyundai	HL980	6.3	32	80	20	50
Hyundai	HL980 XTD	6.3	32	80	20	50
Kawasaki	85Z	4.2	20	55	20	35
Kawasaki	85ZII	4.2	20	55	20	35
Kawasaki	85ZIII	4.3	20	55	20	35
Kawasaki	85ZIV	4.3	20	55	20	35
Kawasaki	85ZIV-2	4.75	20	60	20	35
Kawasaki	85ZV-2	4.8	20	60	20	35
Kawasaki	85Z7	4.8	20	60	20	35
Kawasaki	85Z7 HL	4.8	20	60	20	35
Kawasaki	90ZIII	5	20	60	20	35
Kawasaki	90ZIV	5	20	60	20	35
Kawasaki	90ZIV-2	5.5	20	65	20	40
Kawasaki	90ZV	5.2	20	65	20	35
Kawasaki	90ZV	4.25	20	55	20	35
Kawasaki	90ZV-2	5.2	20	65	20	35
Kawasaki	90Z7	5.5	20	65	20	40
Kawasaki	90Z7 HL	5.5	26	70	20	40
Kawasaki	90Z7B	5.5	20	65	20	40
Kawasaki	90Z7B HL	5.5	26	70	20	40
Kawasaki	92ZV-2	6	26	70	20	45
Kawasaki	92Z7	6.3	26	75	20	45
Kawasaki	92Z7 HL	6.3	32	80	20	50
Kawasaki	95ZV-2	7	32	90	26	55
Komatsu	WA420-1	4.75	20	55	20	35
Komatsu	WA420-3	6	20	65	20	35
Komatsu	WA430-6	4.6	20	55	20	35
Komatsu	WA450-2	5.5	20	65	20	35
Komatsu	WA450-3	6.8	26	70	20	45
Komatsu	WA470-6	5.5	20	65	20	35
Komatsu	WA470-7	5.5	20	65	20	35
Komatsu	WA470-8	5	20	65	20	40
Komatsu	WA470-8 HL	5	20	65	20	40
Komatsu	WA480-6	5.4	20	65	20	40

Manufacturer	Model	Bucket (cu. yd.)	Front Minimum Ply Rating	Front Minimum Inflation (psi)	Rear Minimum Ply Rating	Rear Minimum Inflation (psi)
Komatsu	WA480-8	6	26	70	20	45
Komatsu Dresser	542	4.75	20	60	20	35
Komatsu Dresser	545	5.5	26	70	20	40
Komatsu Dresser	550	5.25	20	65	20	35
Liebherr	L566	5.2	20	65	20	35
Liebherr	L566 HL	4.6	20	60	20	35
Liebherr	L566 XP	5.5	20	70	20	40
Liebherr	L576	6.15	26	70	20	45
Liebherr	L576 HL	5.5	26	70	20	40
Liebherr	L580	6.5	26	70	20	45
Liebherr	L580 HL	5.9	26	70	20	40
Liebherr	L580 XP	6.8	32	80	20	50
Terex	80C	5.5	26	70	20	40
Volvo	L150C	5.2	20	60	20	35
Volvo	L150D	5.2	20	65	20	40
Volvo	L150F	5.8	26	70	20	40
Volvo	L150G	6.8	26	75	20	45
Volvo	L150H	5.25	20	65	20	35
Volvo	L180	5.5	20	65	20	40
Volvo	L180C	6	26	70	20	40
Volvo	L180D	6.3	26	75	20	45
Volvo	L180F	6.3	26	75	20	45
Volvo	L180G	7.6	32	85	20	50
Volvo	L180H	5.75	26	75	20	45
Volvo	L190	5.2	20	70	20	40
Volvo	L190B	5.2	20	70	20	40

For service under chains, or load and carry operations, contact Titan Technical Services.

Pressure and ply recommendations based on normal quarry operations with standard equipment. For different applications, or modified equipment, please contact OTR Field Engineering for a specific recommendation. Tire damage or failure caused by improper load, ply, speed or inflation practices is not covered by the Titan Tire Warranty Policy.

CT - Contact Titan Technical services
HL - High Lift, extended booms, etc.

29.5-25 LOADER USAGE CHART

For Standard Loader Service: <250 ft, < 5 mph



Manufacturer	Model	Bucket (cu. yd.)	Front Minimum Ply Rating	Front Minimum Inflation (psi)	Rear Minimum Ply Rating	Rear Minimum Inflation (psi)
Caterpillar	980C	6.75	28	75	28	45
Caterpillar	980F	7	28	75	28	45
Caterpillar	980F-II	7	28	75	28	45
Caterpillar	980G	7	28	75	28	45
Caterpillar	980H	7.5	28	75	28	45
Caterpillar	980K	7.5	28	75	28	45
Caterpillar	980M	7.5	28	75	28	45
Case	1221E	9.2	28	50	28	35
Case	1221E XR	9.2	28	50	28	35
Deere	744J	5.25	28	55	28	35
Deere	744J HL	5.25	28	60	28	35
Deere	824J	6	28	65	28	35
Deere	824J HL	5.25	28	60	28	35
Deere	824K	6	28	65	28	35
Deere	824K HL	6	28	65	28	40
Deere	824K-II	6	28	65	28	35
Deere	824K-II HL	6	28	65	28	40
Deere	844J	7.25	28	75	28	45
Deere	844K	7.25	28	75	28	45
Deere	844K-II	7.25	28	80	28	50
Deere	844K-III	7.25	28	80	28	50
Deere	844L	7.25	28	80	28	50
Doosan	DL500	6.8	28	70	28	40
Doosan	DL550-5	7.5	28	80	28	45
Doosan	DL550-5 HL	7.5	34	85	28	50
Furukawa	FL460	6	28	70	28	40
Hitachi	ZW370-5	8.1	34	85	28	55
Hitachi	ZW370-5 HL	7.3	34	85	28	50
Hitachi	ZW370-6	7.3	28	80	28	50
Hitachi	ZW370-6 HL	7.3	34	85	28	50
Hyundai	HL780-7A	6.7	28	70	28	40
Hyundai	HL780XTD-7A	6.7	28	70	28	45
Hyundai	HL780-9	7.1	28	70	28	45
Hyundai	HL780XTD-9	7.1	28	75	28	45
Hyundai	HL780-9A	7.1	28	75	28	45
Hyundai	HL780XTD-9A	7.1	28	75	28	45
Hyundai	HL980	6.3	28	70	28	40
Hyundai	HL980 XTD	6.3	28	70	28	45
Kawasaki	95Z	6	28	65	28	40
Kawasaki	95ZII	6	28	65	28	40
Kawasaki	95ZIII	6.5	28	70	28	40
Kawasaki	95ZIV	6.5	28	70	28	40
Kawasaki	95ZIV-2	7.25	28	75	28	45
Kawasaki	95ZIV-3	7.25	28	75	28	45
Kawasaki	95ZV-2	7	28	75	28	45
Kawasaki	95Z7	7.3	34	80	28	50

Manufacturer	Model	Bucket (cu. yd.)	Front Minimum Ply Rating	Front Minimum Inflation (psi)	Rear Minimum Ply Rating	Rear Minimum Inflation (psi)
Kawasaki	95Z7 HL	7.3	34	85	28	50
Komatsu	WA500-1	6	28	65	28	40
Komatsu	WA500-3	7.2	28	70	28	45
Komatsu	WA500-6	7.3	28	80	28	50
Komatsu	WA500-7	7.3	28	80	28	50
Komatsu	WA500-7 HL	5.9	28	70	28	40
Komatsu	WA500-7 SM	5.25	28	70	28	45
Komatsu	WA500-8	7.6	34	80	28	50
Komatsu	WA500-8 HL	5.9	28	75	28	45
Komatsu Dresser	555	6	28	70	28	40
Komatsu Dresser	558	6	28	65	28	40
Liebherr	L586	7.85	34	80	28	50
Liebherr	L586 HL	7.2	28	80	28	50
Liebherr	586XP	7.8	34	85	28	50
Volvo	L190	5.2	28	60	28	35
Volvo	L190B	5.2	28	60	28	35
Volvo	L220D	7	28	70	28	40
Volvo	L220E	7.1	28	75	28	45
Volvo	L220F	6.3	28	75	28	45
Volvo	L220F	7.8	28	80	28	50
Volvo	L220G	8.2	34	85	28	50
Volvo	L220H	6.8	28	75	28	45
Volvo	L260H	8.4	34	85	28	55
Volvo	L260H HL	7.2	28	80	28	50

For service under chains, or load and carry operations, contact Titan Technical Services.

Pressure and ply recommendations based on normal quarry operations with standard equipment. For different applications, or modified equipment, please contact OTR Field Engineering for a specific recommendation. Tire damage or failure caused by improper load, ply, speed or inflation practices is not covered by the Titan Tire Warranty Policy.

CT - Contact Titan Technical services
HL - High Lift, extended booms, etc.

725/70-25 LOADER USAGE CHART

For Standard Loader Service: <250 ft, < 5 mph



Manufacturer	Model	Bucket (cu. yd.)	Front Minimum Ply Rating	Front Minimum Inflation (psi)	Rear Minimum Ply Rating	Rear Minimum Inflation (psi)
Caterpillar	950K	3.5	16	50	16	35
Caterpillar	950K HL	3.5	16	50	16	35
Caterpillar	950M	4	16	55	16	35
Caterpillar	950M HL	4	CT	CT	16	35
Caterpillar	966C	4	16	50	16	35
Caterpillar	966D	4.25	CT	CT	16	35
Caterpillar	966G	4.75	CT	CT	16	35
Caterpillar	966H	5.5	CT	CT	16	40
Caterpillar	966H	5.75	CT	CT	CT	40
Caterpillar	966K	5.5	CT	CT	CT	40
Caterpillar	966L	5.5	CT	CT	16	40
Caterpillar	966M	5.5	CT	CT	16	40
Caterpillar	966M XE	5.5	CT	CT	16	40
Deere	644K	4.25	16	50	16	35
Deere	644K HL	4.25	16	55	16	35
Volvo	L180	5.5	CT	CT	16	40
Volvo	L180C	6	CT	CT	CT	40
Volvo	L180D	6.3	CT	CT	CT	45
Volvo	L180F	6.3	CT	CT	CT	45
Volvo	L180G	7.6	CT	CT	CT	50
Volvo	L180H	5.75	CT	CT	CT	45

For service under chains, or load and carry operations, contact Titan Technical Services.

Pressure and ply recommendations based on normal quarry operations with standard equipment. For different applications, or modified equipment, please contact OTR Field Engineering for a specific recommendation. Tire damage or failure caused by improper load, ply, speed or inflation practices is not covered by the Titan Tire Warranty Policy.

CT - Contact Titan Technical services

HL - High Lift, extended booms, etc.

35/65-33 LOADER USAGE CHART

For Standard Loader Service: <250 ft, < 5 mph



PIT LOADER APPLICATION							YARD LOADER APPLICATION						
Manufacturer	Model	Bucket (cu. yd.)	Front Minimum Ply Rating	Front Minimum Inflation (psi)	Rear Minimum Ply Rating	Rear Minimum Inflation (psi)	Manufacturer	Model	Bucket (cu. yd.)	Front Minimum Ply Rating	Front Minimum Inflation (psi)	Rear Minimum Ply Rating	Rear Minimum Inflation (psi)
Caterpillar	986H	6.12	42	85	42	50	Caterpillar	986H	6.12	42	75	42	45
Caterpillar	986H HL	5.35	42	80	42	50	Caterpillar	986H HL	5.35	42	70	42	45
Caterpillar	986K	6.8	42	90	42	55	Caterpillar	986K	6.8	42	80	42	50
Caterpillar	986K HL	5.8	42	85	42	55	Caterpillar	986K HL	5.8	42	75	42	45
Caterpillar	988B	8.25	42	105	42	65	Caterpillar	988B	8.25	42	90	42	55
Caterpillar	988F	7.75	42	100	42	65	Caterpillar	988F	7.75	42	90	42	55
Caterpillar	988G	8	CT	CT	42	70	Caterpillar	988G	8	42	95	42	60
Caterpillar	988H	8.2	CT	CT	42	75	Caterpillar	988H	8.2	42	100	42	65
Caterpillar	988H	8.33	CT	CT	42	75	Caterpillar	988H	8.33	42	100	42	65
Caterpillar	988H	9.2	CT	CT	42	80	Caterpillar	988H	9.2	42	105	42	65
Caterpillar	988H HL	8.33	CT	CT	42	75	Caterpillar	988H HL	8.33	42	100	42	60
Caterpillar	988K	8.4	CT	CT	42	75	Caterpillar	988K	8.4	42	100	42	65

CONTINUES ON NEXT PAGE

35/65-33 LOADER USAGE CHART CONTINUED

For Standard Loader Service: <250 ft, < 5 mph



PIT LOADER APPLICATION							YARD LOADER APPLICATION						
Manufacturer	Model	Bucket (cu. yd.)	Front Minimum Ply Rating	Front Minimum Inflation (psi)	Rear Minimum Ply Rating	Rear Minimum Inflation (psi)	Manufacturer	Model	Bucket (cu. yd.)	Front Minimum Ply Rating	Front Minimum Inflation (psi)	Rear Minimum Ply Rating	Rear Minimum Inflation (psi)
Caterpillar	988K HL	8.4	CT	CT	42	75	Caterpillar	988K HL	8.4	42	100	42	65
Caterpillar	988K Steel Mill	5.5	42	80	42	50	Caterpillar	988K Steel Mill	5.5	42	105	42	65
Caterpillar	988K Steel Mill	6.5	42	85	42	50	Caterpillar	988K Steel Mill	6.5	42	105	42	65
Caterpillar	988K XE	9.2	CT	CT	42	80	Caterpillar	988K XE	9.2	42	105	42	70
Deere	944K	10	CT	CT	42	80	Deere	944K	10	42	105	42	65
Deere	944K HL	10	CT	CT	42	85	Deere	944K HL	10	42	110	42	70
Hitachi	ZW550-5	8.9	42	110	42	70	Hitachi	ZW550-5	8.9	42	90	42	60
Hitachi	ZW550-5 HL	7.3	42	100	42	65	Hitachi	ZW550-5 HL	7.3	42	85	42	55
Hitachi	ZW550-6	8.2	42	105	42	65	Hitachi	ZW550-6	8.2	42	90	42	55
Hitachi	ZW550-6 HL	9	42	115	42	75	Hitachi	ZW550-6 HL	9	42	95	42	60
Kawasaki	110Z	7.5	42	95	42	60	Kawasaki	110Z	7.5	42	80	42	50
Kawasaki	110ZII	7.5	42	95	42	60	Kawasaki	110ZII	7.5	42	80	42	50
Kawasaki	115ZIII	7.5	42	95	42	60	Kawasaki	115ZIII	7.5	42	80	42	50
Kawasaki	115ZIV	7.5	42	100	42	65	Kawasaki	115ZIV	7.5	42	85	42	55
Kawasaki	115ZIV-2	8.25	42	105	42	70	Kawasaki	115ZIV-2	8.25	42	90	42	60
Kawasaki	115ZV	7.5	42	100	42	65	Kawasaki	115ZV	7.5	42	85	42	55
Kawasaki	115ZV-2	7.8	42	105	42	65	Kawasaki	115ZV-2	7.8	42	90	42	55
Kawasaki	115ZV-2 HL	6.5	42	95	42	60	Kawasaki	115ZV-2 HL	6.5	42	80	42	50
Kawasaki	115Z7	8.3	42	105	42	65	Kawasaki	115Z7	8.3	42	90	42	55
Kawasaki	115Z7 HL	9	CT	CT	42	75	Kawasaki	115Z7 HL	9	42	95	42	60
Kawasaki	115Z7 Xtreme	9.15	42	110	42	70	Kawasaki	115Z7 Xtreme	9.15	42	90	42	60
Komatsu	WA600-1	7.1	42	90	42	55	Komatsu	WA600-1	7.1	42	75	42	45
Komatsu	WA600-3	8	42	95	42	60	Komatsu	WA600-3	8	42	80	42	50
Komatsu	WA600-6	8.4	CT	CT	42	75	Komatsu	WA600-6	8.4	42	95	42	60
Komatsu	WA600-6	9.2	CT	CT	42	80	Komatsu	WA600-6	9.2	42	85	42	55
Komatsu	WA600-8	8.4	42	115	42	75	Komatsu	WA600-8	8.4	42	100	42	65
Komatsu Dresser	568	7.5	42	95	42	60	Komatsu Dresser	568	7.5	42	80	42	50
O&K	7500	7	42	90	42	55	O&K	7500	7	42	80	42	50
Sandvik	LH621-10	10.5	CT	CT	42	75	Sandvik	LH621-10	10.5	CT	CT	42	75
Terex	90C	8.5	42	105	42	65	Terex	90C	8.5	42	90	42	55
Volvo	L320	8	42	100	42	65	Volvo	L320	8	42	90	42	55
Volvo	L330C	8.6	42	110	42	70	Volvo	L330C	8.6	42	95	42	60
Volvo	L330D	8.6	42	110	42	70	Volvo	L330D	8.6	42	95	42	60
Volvo	L330E	8.6	CT	CT	42	70	Volvo	L330E	8.6	42	95	42	60
Volvo	L350F	10.1	CT	CT	42	80	Volvo	L350F	10.1	42	105	42	65
Volvo	L350H	9.5	42	115	42	75	Volvo	L350H	9.5	42	95	42	60
Volvo	L350H HL	9.5	42	120	42	75	Volvo	L350H HL	9.5	42	100	42	65

For service under chains, or load and carry operations, contact Titan Technical Services.

Pressure and ply recommendations based on normal quarry operations with standard equipment. For different applications, or modified equipment, please contact OTR Field Engineering for a specific recommendation. Tire damage or failure caused by improper load, ply, speed or inflation practices is not covered by the Titan Tire Warranty Policy.

CT - Contact Titan Technical services

HL - High Lift, extended booms, etc.

40/65-39 LOADER USAGE CHART

For Standard Loader Service: <250 ft, < 5 mph



Manufacturer	Model	Bucket (cu. yd.)	Front Minimum Ply Rating	Front Minimum Inflation (psi)	Rear Minimum Ply Rating	Rear Minimum Inflation (psi)
Komatsu	WA700-1	11.1	CT	CT	42	50
Komatsu	WA700-3	11.4	CT	CT	42	50
Komatsu	WA700-3	12.3	CT	CT	42	55

45/65-45 LOADER USAGE CHART

For Standard Loader Service: <250 ft, < 5 mph



Manufacturer	Model	Bucket (cu. yd.)	Front Minimum Ply Rating	Front Minimum Inflation (psi)	Rear Minimum Ply Rating	Rear Minimum Inflation (psi)
Caterpillar	992B	10	58	70	58	40
Caterpillar	992C	12.5	58	95	58	60
Caterpillar	992C HL	12.5	58	100	58	65
Caterpillar	992D	14	58	95	58	60
Caterpillar	992D HL	14	58	100	58	65
Caterpillar	992G	16	58	110	58	70
Caterpillar	992G HL	16	58	115	58	75
Caterpillar	992K	14	58	115	58	75
Caterpillar	992K HL	14	58	110	58	70
Komatsu	WA800-2	13.7	58	95	58	60
Komatsu	WA800-3	14.4	58	95	58	60
Komatsu	WA900-3	17	58	105	58	70
Komatsu	WA900-3 HL	15	58	115	58	75
Komatsu	WA900-8	17	58	120	58	75
Komatsu	WA900-8 HL	15	58	115	58	75
LeTourneau	L-950-2	18	58	115	58	75
LeTourneau	L-950-2 HL	16	58	110	58	70
LeTourneau	L1000	17	58	105	58	70

41.25/70-39 LOADER USAGE CHART

For Standard Loader Service: <250 ft, < 5 mph



Manufacturer	Model	Bucket (cu. yd.)	Front Minimum Ply Rating	Front Minimum Inflation (psi)	Rear Minimum Ply Rating	Rear Minimum Inflation (psi)
Caterpillar	990	11	42	75	42	45
Caterpillar	990H	11.25	42	90	42	55
Caterpillar	990K	11.25	42	90	42	55
Caterpillar	990K HL	11.25	42	95	42	60
Kawasaki	135ZV-2	12.8	42	85	42	55
Kawasaki	135ZV-2 HL	11.5	42	80	42	50
Komatsu	WA700-1	11.1	42	70	42	45
Komatsu	WA700-3	11.4	42	75	42	45
Komatsu	WA700-3	12.3	42	75	42	45
Volvo	L480B	12.5	42	90	42	55

For service under chains, or load and carry operations, contact Titan Technical Services.

Pressure and ply recommendations based on normal quarry operations with standard equipment. For different applications, or modified equipment, please contact OTR Field Engineering for a specific recommendation. Tire damage or failure caused by improper load, ply, speed or inflation practices is not covered by the Titan Tire Warranty Policy.

CT - Contact Titan Technical services

HL - High Lift, extended booms, etc.

BIAS RIGID DUMP TRUCK

18.00-25 RIGID DUMP TRUCK USAGE CHART

For Standard Earthmover Service: <2.5 mile, < 30 mph



Manufacturer	Model	Bucket (cu. yd.)	Front Minimum Ply Rating	Front Minimum Inflation (psi)	Rear Minimum Ply Rating	Rear Minimum Inflation (psi)
Euclid	R32 w/ liners	34	40	85	40	95
Euclid	R32 w/o liners	36	40	85	40	95
International	350B (Detroit)	50	40	95	CT	CT
International	350B (Cummins)	50	CT	CT	CT	CT
Terex	33-05B	30	32	80	32	80

18.00-33 RIGID DUMP TRUCK USAGE CHART

For Standard Earthmover Service: <2.5 mile, < 30 mph



Manufacturer	Model	Bucket (cu. yd.)	Front Minimum Ply Rating	Front Minimum Inflation (psi)	Rear Minimum Ply Rating	Rear Minimum Inflation (psi)
Astra	RD 40C	44.1	CT	CT	CT	CT
Caterpillar	769B	35	32	85	32	80
Caterpillar	769C	40	CT	CT	CT	CT
Caterpillar	769D	35	CT	CT	CT	CT
Caterpillar	770	40	CT	CT	CT	CT
Caterpillar	770F	49	CT	CT	CT	CT
Caterpillar	770G	50	CT	CT	CT	CT
Caterpillar	771C Quarry	44	CT	CT	CT	CT
Caterpillar	771D	45	CT	CT	CT	CT
Hitachi	EH650	40	32	80	CT	CT
Hitachi	EH700	42	CT	CT	CT	CT
Hitachi	EH750	42.5	CT	CT	CT	CT
Hitachi	EH750-3	46.2	CT	CT	CT	CT
Euclid	R35	35	CT	CT	CT	CT
Euclid	R36	40	32	80	CT	CT
Euclid	R40	41.5	CT	CT	CT	CT
Euclid	R40C	41.9	CT	CT	CT	CT
Komatsu	HD325-3	35	32	75	32	80
Komatsu	HD325-5	35	32	75	32	85
Komatsu	HD325-6 Quarry	44	CT	CT	CT	CT
Komatsu	HD325-6 4WD	35	CT	CT	CT	CT
Komatsu	HD325-6	44	CT	CT	CT	CT
Komatsu	HD325-7	40	CT	CT	CT	CT
Komatsu	HD325-8	40.3	CT	CT	CT	CT
Komatsu	HD405-7	45.2	CT	CT	CT	CT
Komatsu Haulpak	140M	40	CT	CT	CT	CT
Perlini	DP 405 WD	44.1	CT	CT	CT	CT
Terex	3340	40	CT	CT	CT	CT

Pressure and ply recommendations based on normal quarry operations with standard equipment. For different applications, or modified equipment, please contact OTR Field Engineering for a specific recommendation. Tire damage or failure caused by improper load, ply, speed or inflation practices is not covered by the Titan Tire Warranty Policy.

CT - Contact Titan Technical services

21.00-35 RIGID DUMP TRUCK USAGE CHART

For Standard Earthmover Service: <2.5 mile, < 30 mph



Manufacturer	Model	Bucket (cu. yd.)	Front Minimum Ply Rating	Front Minimum Inflation (psi)	Rear Minimum Ply Rating	Rear Minimum Inflation (psi)
Caterpillar	773	50	42	95	42	90
Caterpillar	773B	58	CT	CT	CT	CT
Dart	2085	85	36	70	42	90
Euclid	R50	58.1	CT	CT	CT	CT
Komatsu	HD460-1	51	42	85	42	95
Terex	3345	45	42	85	36	80
Terex	3307	49	42	85	42	85
Terex	3308E	55	CT	CT	CT	CT
Terex	TR45	45	42	85	42	85

Pressure and ply recommendations based on normal quarry operations with standard equipment. For different applications, or modified equipment, please contact OTR Field Engineering for a specific recommendation. Tire damage or failure caused by improper load, ply, speed or inflation practices is not covered by the Titan Tire Warranty Policy.

CT - Contact Titan Technical services

24.00-35 RIGID DUMP TRUCK USAGE CHART

For Standard Earthmover Service: <2.5 mile, < 30 mph



Manufacturer	Model	Bucket (cu. yd.)	Front Minimum Ply Rating	Front Minimum Inflation (psi)	Rear Minimum Ply Rating	Rear Minimum Inflation (psi)
Caterpillar	773	50	42	65	42	65
Caterpillar	773B	58	42	75	42	75
Caterpillar	773D	50	42	75	42	75
Caterpillar	773E	60	42	80	42	85
Caterpillar	773F	61	48	90	42	80
Caterpillar	773G	54	42	75	42	75
Caterpillar	773G-4T	69.3	48	90	42	85
Caterpillar	775B Quarry	65	42	85	42	85
Caterpillar	775D	65	42	85	48	95
Caterpillar	775E	70	42	85	CT	CT
Caterpillar	775F	70	48	95	48	95
Caterpillar	775G	70	CT	CT	CT	CT
Caterpillar	775G-4T	78.8	CT	CT	48	95
Dart	2085	85	42	50	42	65
Euclid	R50	58.1	42	75	42	75
Euclid	R60	63.1	42	75	42	80
Euclid	R60C	66	48	95	42	80
Euclid	R65	69.2	42	85	48	85
Euclid	R65C	71.1	48	90	48	95
Euclid	R75	75	CT	CT	48	95
Hitachi	EH 1000	66	42	85	48	85
Hitachi	EH 1100	72.3	48	90	48	95
Hitachi	EH 1100-3	71.5	48	90	CT	CT
Hitachi	EH1100-5	70	CT	CT	48	90
Komatsu	HD465-3	51	42	65	42	70
Komatsu	HD465-5	61	42	65	42	70

CONTINUES ON NEXT PAGE

24.00-35 RIGID DUMP TRUCK USAGE CHART CONTINUED

For Standard Earthmover Service: <2.5 mile, < 30 mph



Manufacturer	Model	Bucket (cu. yd.)	Front Minimum Ply Rating	Front Minimum Inflation (psi)	Rear Minimum Ply Rating	Rear Minimum Inflation (psi)
Komatsu	HD465-5 Quarry	66	48	85	48	95
Komatsu	HD465-7	61	42	80	42	85
Komatsu	HD465-8	61	48	100	48	100
Komatsu	HD605-7	70	48	90	CT	CT
Komatsu	HD605-8	69.4	48	100	48	100
Komatsu-Haulpak	210M	60	42	80	42	80
Perlini	DP705 WD	71.6	48	90	48	95
Terex	3308E	55	42	75	42	75
Terex	3309	55	42	80	42	80
Terex	3310E	66	48	90	48	90
Terex	TR60	60	42	80	42	80
Terex	TR70	72	CT	CT	CT	CT

24.00-49 RIGID DUMP TRUCK USAGE CHART

For Standard Earthmover Service: <2.5 mile, < 30 mph



Manufacturer	Model	Bucket (cu. yd.)	Front Minimum Ply Rating	Front Minimum Inflation (psi)	Rear Minimum Ply Rating	Rear Minimum Inflation (psi)
Euclid	R85	85	48	90	CT	CT
Euclid	R85B	90	CT	CT	CT	CT

Pressure and ply recommendations based on normal quarry operations with standard equipment. For different applications, or modified equipment, please contact OTR Field Engineering for a specific recommendation. Tire damage or failure caused by improper load, ply, speed or inflation practices is not covered by the Titan Tire Warranty Policy.

CT - Contact Titan Technical services

27.00-49 RIGID DUMP TRUCK USAGE CHART

For Standard Earthmover Service: <2.5 mile, < 30 mph



Manufacturer	Model	Bucket (cu. yd.)	Front Minimum Ply Rating	Front Minimum Inflation (psi)	Rear Minimum Ply Rating	Rear Minimum Inflation (psi)
Caterpillar	777	85	48	75	48	75
Caterpillar	777B	95	48	80	48	85
Caterpillar	777C	95	48	85	48	85
Caterpillar	777D	100	CT	CT	CT	CT
Caterpillar	777E	108	48	85	CT	CT
Caterpillar	777F	100	CT	CT	CT	CT
Caterpillar	777G	100	CT	CT	CT	CT
Dart	3100B	100	CT	CT	CT	CT
Euclid	R85B	85	48	85	48	85
Euclid	R90	95.7	48	85	CT	CT
Euclid	R90C	100	CT	CT	CT	CT
Euclid	R100	100	CT	CT	CT	CT
Hitachi	EH1600	98.9	CT	CT	CT	CT
Hitachi	EH1700	108.4	CT	CT	CT	CT

CONTINUES ON NEXT PAGE

27.00-49 RIGID DUMP TRUCK USAGE CHART CONTINUED

For Standard Earthmover Service: <2.5 mile, < 30 mph



Manufacturer	Model	Bucket (cu. yd.)	Front Minimum Ply Rating	Front Minimum Inflation (psi)	Rear Minimum Ply Rating	Rear Minimum Inflation (psi)
Hitachi	EH1700-3	100	CT	CT	CT	CT
Komatsu	HD785-1	86	48	70	48	75
Komatsu	HD785-3	86	48	75	48	80
Komatsu	HD785-3	100	48	80	CT	CT
Komatsu	HD785-5	106	CT	CT	CT	CT
Komatsu	HD785-7	100	CT	CT	CT	CT
Komatsu	HD785-8	100	CT	CT	CT	CT
Komatsu Haulpak	325M	95	48	85	48	85
Komatsu Haulpak	330M	100	CT	CT	CT	CT
Kress	CH160	160	CT	CT	CT	CT
Kress	CH180	180	CT	CT	CT	CT
Liebherr	T236	110	CT	CT	CT	CT
Perlini	DP905	104.7	CT	CT	CT	CT
Rimpull	RD100	100	48	85	CT	CT
Rimpull	RD100C	100	48	85	CT	CT
Terex	3311C	85	48	75	48	70
Terex	3311D	77	48	85	48	75
Terex	3311E	94	CT	CT	48	80
Terex	TR100	100	CT	CT	CT	CT
Terex	TR100 (HR)	93.55	CT	CT	CT	CT
Terex	TR100D	100	CT	CT	CT	CT
Unit Rig	Dart 3100	100	CT	CT	CT	CT
Unit Rig	Dart 4160	160	48	60	CT	CT
Unit Rig	M85	85	48	70	48	70
Unit Rig	M100	100	CT	CT	CT	CT
Unit Rig	M120-15	120	CT	CT	CT	CT
Unit Rig	Mark 24	85	48	85	48	70

30.00-51 RIGID DUMP TRUCK USAGE CHART

For Standard Earthmover Service: <2.5 mile, < 30 mph



Manufacturer	Model	Bucket (cu. yd.)	Front Minimum Ply Rating	Front Minimum Inflation (psi)	Rear Minimum Ply Rating	Rear Minimum Inflation (psi)
Dart	3120B	120	CT	CT	CT	CT
Euclid	R100	100	52	70	52	70
Euclid	R120E	120	CT	CT	CT	CT

Pressure and ply recommendations based on normal quarry operations with standard equipment. For different applications, or modified equipment, please contact OTR Field Engineering for a specific recommendation. Tire damage or failure caused by improper load, ply, speed or inflation practices is not covered by the Titan Tire Warranty Policy.

CT - Contact Titan Technical services

33.00-51 RIGID DUMP TRUCK USAGE CHART

For Standard Earthmover Service: <2.5 mile, < 30 mph



Manufacturer	Model	Bucket (cu. yd.)	Front Minimum Ply Rating	Front Minimum Inflation (psi)	Rear Minimum Ply Rating	Rear Minimum Inflation (psi)
Belaz	75131	143.3004704	CT	CT	CT	CT
Belaz	75137NA	143.3004704	CT	CT	CT	CT
Caterpillar	785	155	CT	CT	CT	CT
Caterpillar	785B	155	CT	CT	CT	CT
Caterpillar	785C	150	CT	CT	CT	CT
Caterpillar	785D	146	CT	CT	CT	CT
Caterpillar	785G	146	CT	CT	CT	CT
Euclid	R120E	120	58	70	58	75
Euclid	R130	152	CT	CT	CT	CT
Euclid	R130B	146	CT	CT	CT	CT
Euclid	R130M	130	58	70	58	80
Euclid	R150	150	CT	CT	CT	CT
Komatsu Haulpak	510E	150	CT	CT	CT	CT
Komatsu Haulpak	530M	165	CT	CT	CT	CT
Komatsu	HD1500-7	160	CT	CT	CT	CT
Terex	MT3300	150	CT	CT	CT	CT
Terex	MT3300AC	150	CT	CT	CT	CT
Terex	MT3314B	125	58	80	58	75

Pressure and ply recommendations based on normal quarry operations with standard equipment. For different applications, or modified equipment, please contact OTR Field Engineering for a specific recommendation. Tire damage or failure caused by improper load, ply, speed or inflation practices is not covered by the Titan Tire Warranty Policy.

CT - Contact Titan Technical services

BIAS TOWED SCRAPER

20.5-25 TOWED SCRAPER USAGE CHART

For Standard Scraper Service: <2.5 mile, < 30 mph



Manufacturer	Model	Payload (cu. yd.)	Tires Per Axle	Tire Min. Ply Rating	Tire Min. Inflation (psi)
Ashland	110TS2	11.3	2	CT	CT
Ashland	110XL2	11	2	CT	CT
Ashland	130TS2	13	2	CT	CT
Ashland	220TS4	22	4	CT	CT
Ashland	1410E	14	2	CT	CT
Ashland	2012CS	20	4	CT	CT
Ashland	2014CS	20	6	16	40
Deere	1510DC	15	4	16	40
Deere	1612DE	16	4	24	50
Deere	1810DC	18	4	24	50
Deere	1812DC	18	4	20	50
Deere	1814DC	18	6	16	30
Deere	2010DE	20	4	CT	CT
Deere	2014DE	20	6	16	40

Pressure and ply recommendations based on normal quarry operations with standard equipment. For different applications, or modified equipment, please contact OTR Field Engineering for a specific recommendation. Tire damage or failure caused by improper load, ply, speed or inflation practices is not covered by the Titan Tire Warranty Policy.

CT - Contact Titan Technical services

23.5-25 TOWED SCRAPER USAGE CHART

For Standard Scraper Service: <2.5 mile, < 30 mph



Manufacturer	Model	Payload (cu. yd.)	Tires Per Axle	Tire Min. Ply Rating	Tire Min. Inflation (psi)
Ashland	140TS2	14	2	CT	CT
Ashland	140TS2 LGP	14	2	CT	CT
Caterpillar	TS185	19	4	20	35
Deere	2112DC	21.5	6	12	30
Deere	2412DE	24	4	CT	CT
K-Tec	1228	28	4	CT	CT
K-Tec	1228 ADT	28	4	CT	CT
K-Tec	1233	33	4	CT	CT
K-Tec	1236	36	4	CT	CT

Pressure and ply recommendations based on normal quarry operations with standard equipment. For different applications, or modified equipment, please contact OTR Field Engineering for a specific recommendation. Tire damage or failure caused by improper load, ply, speed or inflation practices is not covered by the Titan Tire Warranty Policy.

CT - Contact Titan Technical services

26.5-25 TOWED SCRAPER USAGE CHART

For Standard Scraper Service: <2.5 mile, < 30 mph



Manufacturer	Model	Payload (cu. yd.)	Tires Per Axle	Tire Min. Ply Rating	Tire Min. Inflation (psi)
Caterpillar	TS185	19	4	20	30
Caterpillar	TS225	23.5	4	20	35
Deere	2112DC (1)	21.5	4	32	55
Deere	2112DC (2)	21.5	4	20	35
Deere	2412DE (1)	24	4	44	60
Deere	2412DE (2)	24	4	26	45
K-Tec	1233	33	4	32	50
K-Tec	1237 ADT	40.5	4	CT	CT
K-Tec	1243 ADT	43	4	26	45

Pressure and ply recommendations based on normal quarry operations with standard equipment. For different applications, or modified equipment, please contact OTR Field Engineering for a specific recommendation. Tire damage or failure caused by improper load, ply, speed or inflation practices is not covered by the Titan Tire Warranty Policy.

CT - Contact Titan Technical services

(1) - Front scraper used in train

(2) - Rear scraper used in train, or single scraper

29.5-25 TOWED SCRAPER USAGE CHART

For Standard Scraper Service: <2.5 mile, < 30 mph



Manufacturer	Model	Payload (cu. yd.)	Tires Per Axle	Tire Min. Ply Rating	Tire Min. Inflation (psi)
Ashland	155TS2	15.5	2	28	45
Ashland	215TS2	21.5	2	34	60
Caterpillar	TS180	19	2	34	50
Deere	2010DE	20	2	34	55
K-Tec	1243 ADT	43	4	28	35
K-Tec	1263 ADT	63	4	34	50

Pressure and ply recommendations based on normal quarry operations with standard equipment. For different applications, or modified equipment, please contact OTR Field Engineering for a specific recommendation. Tire damage or failure caused by improper load, ply, speed or inflation practices is not covered by the Titan Tire Warranty Policy.

CT - Contact Titan Technical services

BIAS TRACTOR SCRAPER

18.00-25 TRACTOR SCRAPER USAGE CHART

For Standard Scraper Service: <2.5 mile, < 30 mph



Manufacturer	Model	Payload (cu. yd.)	Front Minimum Ply Rating	Front Minimum Inflation (psi)	Rear Minimum Ply Rating	Rear Minimum Inflation (psi)
Caterpillar	613C II	11	32	60	32	65

23.5-25 TRACTOR SCRAPER USAGE CHART

For Standard Scraper Service: <2.5 mile, < 30 mph



Manufacturer	Model	Payload (cu. yd.)	Front Minimum Ply Rating	Front Minimum Inflation (psi)	Rear Minimum Ply Rating	Rear Minimum Inflation (psi)
Caterpillar	613B	11	20	35	20	40
Caterpillar	613C	11	20	40	20	40
Caterpillar	613C II	11	20	40	20	40
Caterpillar	613G	11	CT	CT	20	40
Deere	762	11	20	40	20	40
Deere	762A	11	20	45	20	40
Deere	762B	11	20	45	20	40
Deere	762B II	11	20	45	20	40
Komatsu Dresser	412	11	20	40	20	40
Komatsu Dresser	412B	11	20	40	20	40

26.5-25 TRACTOR SCRAPER USAGE CHART

For Standard Scraper Service: <2.5 mile, < 30 mph



Manufacturer	Model	Payload (cu. yd.)	Front Minimum Ply Rating	Front Minimum Inflation (psi)	Rear Minimum Ply Rating	Rear Minimum Inflation (psi)
Caterpillar	611	15	32	55	32	50
Caterpillar	611C II	15	44	70	32	50
Caterpillar	615	16	32	60	32	50
Caterpillar	615C	16	32	60	32	50
Caterpillar	615C II	17	44	60	32	55
Deere	860	15	26	45	26	45
Deere	860A Std	15	32	50	26	45
Deere	860A HD	15	32	50	26	50
Deere	862	16	32	55	32	55
Deere	862B	16	32	55	32	55
Fiat Allis	161	15	26	45	26	45

Pressure and ply recommendations based on normal quarry operations with standard equipment. For different applications, or modified equipment, please contact OTR Field Engineering for a specific recommendation. Tire damage or failure caused by improper load, ply, speed or inflation practices is not covered by the Titan Tire Warranty Policy.

CT - Contact Titan Technical services

29.5-25 TRACTOR SCRAPER USAGE CHART

For Standard Scraper Service: <2.5 mile, < 30 mph



Manufacturer	Model	Payload (cu. yd.)	Front Minimum Ply Rating	Front Minimum Inflation (psi)	Rear Minimum Ply Rating	Rear Minimum Inflation (psi)
Caterpillar	611	15	28	45	28	40
Caterpillar	611C II	15	28	45	28	40
Caterpillar	615	16	28	45	28	40
Caterpillar	615C	16	28	45	28	40
Caterpillar	615C II	17	28	50	28	45
Deere	862 w/ Kress bowl	18	28	45	28	45
Deere	862 w/ Kress bowl	20	28	50	34	50
Deere	862B	16	28	45	28	45
Fiat Allis	161	15	28	40	28	40
Terex	TS14B	20	34	55	34	50
Terex	TS14C	20	34	55	34	50
Terex	TS14G	20	34	60	34	55

29.5-29 TRACTOR SCRAPER USAGE CHART

For Standard Scraper Service: <2.5 mile, < 30 mph



Manufacturer	Model	Payload (cu. yd.)	Front Minimum Ply Rating	Front Minimum Inflation (psi)	Rear Minimum Ply Rating	Rear Minimum Inflation (psi)
Caterpillar	621B	20	38	60	28	50
Caterpillar	621E	20	34	60	34	50
Caterpillar	621G	22	CT	CT	34	60
Caterpillar	623B	22	CT	CT	34	55
Caterpillar	623E	23	CT	CT	38	60
Caterpillar	623F	23	CT	CT	CT	CT
Caterpillar	627B	20	34	60	38	60
Caterpillar	627E	20	34	60	38	65
Caterpillar	627G	22	38	65	CT	CT
Fiatallis	261B	23	38	60	34	60
Fiatallis	262B	21	38	60	34	60
Fiatallis	263B	23	38	65	CT	CT
Komatsu Dresser	431B	21	34	55	28	50
Komatsu Dresser	433B	21	34	55	34	60
Komatsu Dresser	442B	22	38	60	34	55
Komatsu Dresser	444B	22	38	65	CT	CT
Terex	S23E	23	38	60	34	55

29.5-35 TRACTOR SCRAPER USAGE CHART

For Standard Scraper Service: <2.5 mile, < 30 mph



Manufacturer	Model	Payload (cu. yd.)	Front Minimum Ply Rating	Front Minimum Inflation (psi)	Rear Minimum Ply Rating	Rear Minimum Inflation (psi)
Caterpillar	621B	20	34	55	34	45
Caterpillar	621E	20	34	55	34	45
Caterpillar	623B	23	CT	CT	34	50
Caterpillar	623E	23	CT	CT	34	55
Caterpillar	627B	20	34	55	34	55
Caterpillar	627E	20	34	55	34	60
Terex	S23E	23	34	55	34	50

33.25-29 TRACTOR SCRAPER USAGE CHART

For Standard Scraper Service: <2.5 mile, < 30 mph



Manufacturer	Model	Payload (cu. yd.)	Front Minimum Ply Rating	Front Minimum Inflation (psi)	Rear Minimum Ply Rating	Rear Minimum Inflation (psi)
Caterpillar	621B	20	32	45	32	35
Caterpillar	621E	20	34	45	34	40
Caterpillar	621F	20	34	45	34	40
Caterpillar	621G	20	38	50	34	45
Caterpillar	621G	22	38	50	34	45
Caterpillar	621H	24	38	55	34	50
Caterpillar	621K	24	38	55	34	50
Caterpillar	621K P/P	24	38	55	34	50
Caterpillar	623F	23	38	55	38	55
Caterpillar	623G	23	38	55	38	55
Caterpillar	623H	23	38	60	38	50
Caterpillar	623K	23	CT	CT	38	50
Caterpillar	627B	20	34	45	34	45
Caterpillar	627E	20	34	45	34	50
Caterpillar	627F	20	34	50	38	50
Caterpillar	627G	22	38	55	38	50
Caterpillar	627H	24	CT	CT	CT	CT
Caterpillar	627K	24	CT	CT	38	55
Caterpillar	627K P/P	24	CT	CT	38	55

33.25-35 TRACTOR SCRAPER USAGE CHART

For Standard Scraper Service: <2.5 mile, < 30 mph



Manufacturer	Model	Payload (cu. yd.)	Front Minimum Ply Rating	Front Minimum Inflation (psi)	Rear Minimum Ply Rating	Rear Minimum Inflation (psi)
Caterpillar	631D	31	56	70	38	60
Caterpillar	631E	31	56	75	44	60
Caterpillar	633D	34	56	75	56	75
Caterpillar	637D	31	56	70	56	70
Caterpillar	637E	31	56	75	56	75

33.5-33 TRACTOR SCRAPER USAGE CHART

For Standard Scraper Service: <2.5 mile, < 30 mph



Manufacturer	Model	Payload (cu. yd.)	Front Minimum Ply Rating	Front Minimum Inflation (psi)	Rear Minimum Ply Rating	Rear Minimum Inflation (psi)
Terex	TS24	33	44	55	44	65
Terex	TS36	40	CT	CT	CT	CT
Terex	TS40	50	CT	CT	CT	CT

Pressure and ply recommendations based on normal quarry operations with standard equipment. For different applications, or modified equipment, please contact OTR Field Engineering for a specific recommendation. Tire damage or failure caused by improper load, ply, speed or inflation practices is not covered by the Titan Tire Warranty Policy.

CT - Contact Titan Technical services

37.5-33 TRACTOR SCRAPER USAGE CHART

For Standard Scraper Service: <2.5 mile, < 30 mph



Manufacturer	Model	Payload (cu. yd.)	Front Minimum Ply Rating	Front Minimum Inflation (psi)	Rear Minimum Ply Rating	Rear Minimum Inflation (psi)
Terex	TS24B	34	54	60	54	60
Terex	S24B	34	54	60	54	55
Terex	TS38B	41	54	70	54	65

37.25-35 TRACTOR SCRAPER USAGE CHART

For Standard Scraper Service: <2.5 mile, < 30 mph



Manufacturer	Model	Payload (cu. yd.)	Front Minimum Ply Rating	Front Minimum Inflation (psi)	Rear Minimum Ply Rating	Rear Minimum Inflation (psi)
Caterpillar	631D	31	CT	CT	36	45
Caterpillar	631E	31	CT	CT	36	45
Caterpillar	631E II	31	CT	CT	36	45
Caterpillar	631G	34	CT	CT	CT	CT
Caterpillar	631K	34	CT	CT	CT	CT
Caterpillar	631K P/P	34	CT	CT	CT	CT
Caterpillar	633D	34	CT	CT	CT	CT
Caterpillar	633E	34	CT	CT	CT	CT
Caterpillar	633E II	34	CT	CT	CT	CT
Caterpillar	637D	31	CT	CT	CT	CT
Caterpillar	637E	31	CT	CT	CT	CT
Caterpillar	637E II	31	CT	CT	CT	CT
Caterpillar	637G	34	CT	CT	CT	CT
Caterpillar	637G P/P	34	CT	CT	CT	CT
Caterpillar	637K	34	CT	CT	CT	CT
Caterpillar	637K P/P	34	CT	CT	CT	CT
Caterpillar	657G	44	CT	CT	CT	CT
Caterpillar	657G P/P	44	CT	CT	CT	CT

37.5-39 TRACTOR SCRAPER USAGE CHART

For Standard Scraper Service: <2.5 mile, < 30 mph



Manufacturer	Model	Payload (cu. yd.)	Front Minimum Ply Rating	Front Minimum Inflation (psi)	Rear Minimum Ply Rating	Rear Minimum Inflation (psi)
Caterpillar	651B	44	52	75	52	70
Caterpillar	651E	44	60	80	52	70
Caterpillar	657B	44	60	80	CT	CT
Caterpillar	657E	44	CT	CT	CT	CT

Pressure and ply recommendations based on normal quarry operations with standard equipment. For different applications, or modified equipment, please contact OTR Field Engineering for a specific recommendation. Tire damage or failure caused by improper load, ply, speed or inflation practices is not covered by the Titan Tire Warranty Policy.

CT - Contact Titan Technical services

RADIAL ARTICULATED DUMP TRUCK

17.5R25 ARTICULATED DUMP TRUCK USAGE CHART

For Standard Earthmover Service: <2.5 mile, < 30 mph



Manufacturer	Model	Payload (tons)	Front Minimum Ply Rating	Front Minimum Inflation (psi)	Middle Minimum Ply Rating	Middle Minimum Inflation (psi)	Rear Minimum Ply Rating	Rear Minimum Inflation (psi)
Bell	B17B	17	2*	CT	2*	CT	2*	CT

20.5R25 ARTICULATED DUMP TRUCK USAGE CHART

For Standard Earthmover Service: <2.5 mile, < 30 mph



Manufacturer	Model	Payload (tons)	Front Minimum Ply Rating	Front Minimum Inflation (psi)	Middle Minimum Ply Rating	Middle Minimum Inflation (psi)	Rear Minimum Ply Rating	Rear Minimum Inflation (psi)
Bell	B18E	20	1*	50	2*	60	2*	60
Bell	B20B	20	1*	45	2*	55	2*	55
Bell	B20D 6x4	18	1*	40	2*	65	2*	60
Bell	B20D 6x6	18	1*	40	2*	65	2*	65
Bell	B20E	20	1*	55	2*	60	2*	60
Caterpillar	D250B	25	2*	70	2*	75	2*	75
Caterpillar	D250D	25	2*	60	2*	75	2*	75
Komatsu	HA250-1	25	2*	75	2*	75	2*	75
Moxy	MT30 LHS	30	CT	CT	CT	CT	CT	CT
Terex	2364	23	2*	70	2*	65	2*	60
Terex	2366	23	2*	70	2*	65	2*	65
Terex	2566B	25	CT	CT	2*	70	2*	70
Terex	2566C	25	CT	CT	2*	75	2*	70
Volvo	A20 6X4	20	CT	-	2*	60	2*	60
Volvo	A20 6x6	20	CT	-	2*	60	2*	60
Volvo	A20C 6X6	20	1*	50	2*	60	2*	60
Volvo	A25 6X4	25	1*	55	2*	75	2*	75
Volvo	A25	25	2*	55	2*	75	2*	75
Volvo	A25B	25	1*	55	2*	75	2*	75

Pressure and ply recommendations based on normal quarry operations with standard equipment. For different applications, or modified equipment, please contact OTR Field Engineering for a specific recommendation. Tire damage or failure caused by improper load, ply, speed or inflation practices is not covered by the Titan Tire Warranty Policy.

CT - Contact Titan Technical services

23.5R25 ARTICULATED DUMP TRUCK USAGE CHART

For Standard Earthmover Service: <2.5 mile, < 30 mph



Manufacturer	Model	Payload (tons)	Front Minimum Ply Rating	Front Minimum Inflation (psi)	Middle Minimum Ply Rating	Middle Minimum Inflation (psi)	Rear Minimum Ply Rating	Rear Minimum Inflation (psi)
Bell	B25B	25	1*	50	1*	50	1*	50
Bell	B25D	26	1*	50	2*	55	2*	55
Bell	B25E	27	1*	45	2*	65	2*	65
Bell	B30B	30	2*	60	2*	70	2*	70
Bell	B30D	30	1*	50	2*	65	2*	65
Bell	B30E	31	1*	50	2*	75	2*	75
Caterpillar	D20D	20	2*	60	1*	40	2*	75
Caterpillar	D250B	25	1*	50	1*	55	1*	55
Caterpillar	D250D	25	1*	45	1*	55	1*	55
Caterpillar	D250E	25	1*	55	2*	65	2*	65
Caterpillar	D300B	30	2*	60	2*	65	2*	65
Caterpillar	D300D	30	2*	55	2*	70	2*	70
Caterpillar	D300E	30	2*	60	2*	70	2*	70
Caterpillar	D350C	35	2*	75	CT	CT	2*	75
Caterpillar	725	25	1*	55	2*	60	2*	60
Caterpillar	725	26	2*	60	2*	70	2*	65
Caterpillar	725C	26	2*	70	2*	60	2*	60
Caterpillar	725C2	27	2*	70	2*	60	2*	60
Caterpillar	730	30	2*	60	2*	75	2*	75
Caterpillar	730	31	2*	65	CT	CT	CT	CT
Caterpillar	730 EJ	31	2*	60	CT	CT	CT	CT
Caterpillar	730C	31	2*	80	2*	70	2*	70
Caterpillar	730C EJ	31	2*	70	CT	CT	CT	CT
Caterpillar	730C2	31	2*	75	2*	70	2*	70
Caterpillar	730C2 EJ	31	2*	65	CT	CT	CT	CT
Deere	250C	25	1*	50	1*	45	1*	50
Deere	250D	25	1*	50	1*	55	1*	55
Deere	250D - II	25	1*	50	1*	55	1*	55
Deere	260E	26	2*	65	2*	70	2*	70
Deere	300C	30	2*	60	2*	65	2*	65
Deere	300D	30	1*	50	2*	65	2*	65
Deere	300D - II	30	1*	55	2*	70	2*	65
Deere	310E	31	2*	60	2*	80	2*	80
Doosan	DA30	31	2*	70	2*	70	2*	70
Doosan	DA30-5	31	2*	70	2*	75	2*	75
Komatsu	HA270-1	27	2*	60	2*	60	2*	60
Komatsu	HM300-1	30	2*	65	2*	80	2*	75
Komatsu	HM300-2	30	2*	65	2*	80	2*	75
Komatsu	HM300-3	31	2*	60	CT	CT	2*	80
Komatsu	HM300-5	31	2*	70	CT	CT	2*	75
Moxy	MT26	26	2*	60	2*	60	2*	60
Moxy	MT30 X	30	2*	75	1*	55	1*	55
Moxy	MT30 LHS	30	2*	60	2*	60	2*	60
Moxy	MT31	31	2*	70	2*	70	2*	70
Randon	RK-628	28	1*	50	2*	60	2*	60
Terex	2566B	25	2*	60	1*	55	1*	50

CONTINUES ON NEXT PAGE

23.5R25 ARTICULATED DUMP TRUCK USAGE CHART CONTINUED

For Standard Earthmover Service: <2.5 mile, < 30 mph



Manufacturer	Model	Payload (tons)	Front Minimum Ply Rating	Front Minimum Inflation (psi)	Middle Minimum Ply Rating	Middle Minimum Inflation (psi)	Rear Minimum Ply Rating	Rear Minimum Inflation (psi)
Terex	2566C	25	2*	60	1*	55	1*	50
Terex	2766B	27.5	2*	65	2*	60	1*	55
Terex	2766C	27.5	2*	65	2*	60	2*	55
Terex	3066	30	2*	65	2*	60	2*	60
Terex	3066C	30	2*	60	2*	70	2*	70
Terex	TA250	27.5	2*	65	2*	65	2*	65
Terex	TA250-9	27.5	2*	70	2*	65	2*	65
Terex	TA300	31	2*	70	2*	70	2*	70
Terex	TA300-T4	31	2*	75	2*	70	2*	70
Terex	TA300-9	31	2*	60	2*	80	2*	80
Volvo	A20 6X4	20	1*	40	CT	-	CT	-
Volvo	A25	25	1*	40	1*	55	1*	55
Volvo	A25 4X4	25	1*	45	1*	40	1*	40
Volvo	A25 6X4	25	1*	40	1*	55	1*	55
Volvo	A25B	25	1*	40	1*	55	1*	55
Volvo	A25B 4X4	25	1*	45	1*	40	1*	40
Volvo	A25C	25	1*	45	2*	55	2*	55
Volvo	A25C 4X4	25	1*	50	1*	40	1*	40
Volvo	A25C 6X6	25	1*	45	2*	55	2*	55
Volvo	A25D	27	1*	55	2*	65	2*	65
Volvo	A25E	27	1*	55	2*	65	2*	65
Volvo	A25E 4X4	26.5	2*	65	CT	-	CT	-
Volvo	A25F	27	2*	60	2*	65	2*	65
Volvo	A25G	26.5	2*	60	2*	65	2*	65
Volvo	A30	30	2*	60	2*	65	2*	65
Volvo	A30C	30	2*	65	2*	70	2*	70
Volvo	A30C 6X6	30	2*	60	2*	65	2*	65
Volvo	A30D	31	2*	60	2*	75	2*	75
Volvo	A30E	31	2*	60	2*	75	2*	75
Volvo	A30F	31	2*	60	2*	75	2*	75
Volvo	A30G	31	2*	60	2*	75	2*	75

Pressure and ply recommendations based on normal quarry operations with standard equipment. For different applications, or modified equipment, please contact OTR Field Engineering for a specific recommendation. Tire damage or failure caused by improper load, ply, speed or inflation practices is not covered by the Titan Tire Warranty Policy.

CT - Contact Titan Technical services

26.5R25 ARTICULATED DUMP TRUCK USAGE CHART

For Standard Earthmover Service: <2.5 mile, < 30 mph



Manufacturer	Model	Payload (tons)	Front Minimum Ply Rating	Front Minimum Inflation (psi)	Middle Minimum Ply Rating	Middle Minimum Inflation (psi)	Rear Minimum Ply Rating	Rear Minimum Inflation (psi)
Bell	B35D	35.8	2*	60	2*	70	2*	70
Bell	B35E	37	2*	65	2*	75	2*	70
Bell	B40	40	2*	65	CT	CT	2*	75
Bell	B40B	40	2*	70	2*	75	2*	75
Bell	B40D 6x4	40	2*	60	CT	CT	2*	75
Caterpillar	D25C	25	2*	65	-	-	2*	75
Caterpillar	D25D	25	2*	65	-	-	2*	75
Caterpillar	D350C	35	2*	55	2*	60	2*	55
Caterpillar	D350D	35	2*	60	2*	60	2*	60
Caterpillar	D400D	40	2*	65	2*	75	2*	75
Caterpillar	735	35	2*	70	2*	70	2*	70
Caterpillar	735	36	2*	75	2*	70	2*	65
Caterpillar	735B	36	CT	CT	2*	70	2*	70
Caterpillar	735B	36	CT	CT	2*	70	2*	65
Caterpillar	735C	36	2*	70	2*	70	2*	70
Deere	350C	35	2*	60	2*	65	2*	65
Deere	350D	35	2*	55	2*	65	2*	65
Deere	350D Series II	35	2*	65	2*	65	2*	65
Deere	370E	37	2*	70	2*	75	2*	70
Deere	370E-II	37	2*	70	2*	80	2*	80
Komatsu	HM350-2	35.6	2*	65	2*	70	2*	70
Moxy	MT36	36	2*	65	2*	65	2*	65
Moxy	MT40	40	2*	60	2*	70	2*	70
Terex	4066	37	1*	50	2*	70	2*	70
Terex	4066B	40	2*	60	2*	75	2*	75
Terex	4066C	40	2*	60	CT	CT	CT	CT
Terex	TA350	37.6	1*	55	CT	CT	CT	CT
Volvo	A35	35	1*	50	2*	65	2*	65
Volvo	A35C	35	1*	50	2*	65	2*	65
Volvo	A35C 6X6	35	1*	50	2*	65	2*	65
Volvo	A35D	36	1*	55	2*	70	2*	70
Volvo	A35E	37	1*	55	2*	75	2*	75
Volvo	A35E-FS	37	1*	55	2*	75	2*	75
Volvo	A35F	37	2*	60	2*	75	2*	75
Volvo	A35F-FS	37	2*	60	2*	75	2*	75
Volvo	A35G	37	2*	60	2*	75	2*	75
Volvo	A35G-FS	37	2*	60	2*	75	2*	75

Pressure and ply recommendations based on normal quarry operations with standard equipment. For different applications, or modified equipment, please contact OTR Field Engineering for a specific recommendation. Tire damage or failure caused by improper load, ply, speed or inflation practices is not covered by the Titan Tire Warranty Policy.

CT - Contact Titan Technical services

29.5R25 ARTICULATED DUMP TRUCK USAGE CHART

For Standard Earthmover Service: <2.5 mile, < 30 mph



Manufacturer	Model	Payload (tons)	Front Minimum Ply Rating	Front Minimum Inflation (psi)	Middle Minimum Ply Rating	Middle Minimum Inflation (psi)	Rear Minimum Ply Rating	Rear Minimum Inflation (psi)
Atlas	FB-645	45	2*	65	2*	70	2*	70
Bell	B40B	40	1*	55	2*	60	2*	55
Bell	B40D	41	1*	50	2*	65	2*	60
Bell	B40E	43	2*	55	2*	65	2*	65
Bell	B45D	45	1*	55	2*	70	2*	70
Bell	B45E	45	2*	60	2*	70	2*	70
Bell	B50E	50	2*	65	CT	CT	CT	CT
Caterpillar	D30C 4x4	30	1*	55	-	-	2*	75
Caterpillar	D30D 4x4	30	1*	55	-	-	2*	75
Caterpillar	D35C	35	1*	55	-	-	-	-
Caterpillar	D40D	40	2*	70	-	-	-	-
Caterpillar	D350C	35	1*	45	1*	45	1*	45
Caterpillar	D350D	35	1*	50	1*	45	1*	45
Caterpillar	D400D	40	1*	55	2*	55	2*	55
Caterpillar	D400E	40	2*	60	1*	55	1*	55
Caterpillar	740	40	2*	65	2*	60	2*	60
Caterpillar	740	43.5	2*	65	2*	65	2*	65
Caterpillar	740 EJ	42	1*	55	2*	70	2*	70
Caterpillar	740B	43.5	2*	70	2*	65	2*	65
Caterpillar	740B EJ	42	2*	60	2*	70	2*	70
Caterpillar	740C EJ	42	2*	60	2*	70	2*	70
Caterpillar	740 GC	40	2*	60	2*	60	2*	60
Caterpillar	745C	45	2*	70	2*	65	2*	65
Deere	370E	37	1*	55	2*	60	2*	60
Deere	400C	40	1*	55	2*	60	2*	55
Deere	400D	40	1*	50	2*	60	2*	60
Deere	400D Series II	40	1*	50	2*	65	2*	60
Deere	410E	41	1*	55	2*	65	2*	65
Deere	410E-II	41	2*	60	2*	70	2*	70
Deere	460E	46	2*	60	2*	70	2*	70
Deere	460E-II	46	2*	65	2*	75	2*	75
Doosan	DA40	44	1*	55	2*	65	2*	65
Doosan	DA40-5	44	2*	55	2*	65	2*	65
Komatsu	HD400	40	1*	45	2*	65	2*	65
Komatsu	HM400-2	40	1*	50	2*	65	2*	65
Komatsu	HM400-3	44	1*	55	2*	70	2*	70
Komatsu	HM400-5	44	2*	60	2*	75	2*	70
Moxy	MT41	41	1*	50	2*	60	2*	60
Moxy	MT51	51	2*	60	2*	75	2*	75
Terex	TA400-9	42	1*	45	2*	70	2*	70
Volvo	A40	40	1*	45	2*	65	2*	65
Volvo	A40D	41	1*	50	2*	65	2*	65
Volvo	A40E	43	1*	50	2*	65	2*	65
Volvo	A40E-FS	43	1*	50	2*	65	2*	65
Volvo	A40F	43	1*	50	2*	65	2*	65
Volvo	A40F-FS	43	1*	50	2*	65	2*	65

CONTINUES ON NEXT PAGE

29.5R25 ARTICULATED DUMP TRUCK USAGE CHART CONTINUED

For Standard Earthmover Service: <2.5 mile, < 30 mph



Manufacturer	Model	Payload (tons)	Front Minimum Ply Rating	Front Minimum Inflation (psi)	Middle Minimum Ply Rating	Middle Minimum Inflation (psi)	Rear Minimum Ply Rating	Rear Minimum Inflation (psi)
Volvo	A40G	43	1*	50	2*	65	2*	65
Volvo	A40G-FS	43	1*	55	2*	65	2*	65
Volvo	A45G	45	1*	55	2*	70	2*	70
Volvo	A45G-FS	45	1*	55	2*	70	2*	70
Volvo	A25 4X4	25	-	-	-	-	2*	70
Volvo	A25B 4X4	25	-	-	-	-	2*	70
Volvo	A25C 4X4	25	-	-	-	-	2*	70
Volvo	A25E 4X4	26.5	-	-	-	-	2*	75

750/65R25 ARTICULATED DUMP TRUCK USAGE CHART

For Standard Earthmover Service: <2.5 mile, < 30 mph



Manufacturer	Model	Payload (tons)	Front Minimum Ply Rating	Front Minimum Inflation (psi)	Middle Minimum Ply Rating	Middle Minimum Inflation (psi)	Rear Minimum Ply Rating	Rear Minimum Inflation (psi)
Bell	B30D	30	1*	40	1*	45	1*	45
Bell	B30E	31	1*	40	1*	50	1*	50
Caterpillar	725C	26	1*	50	1*	40	1*	40
Caterpillar	730C	31	1*	55	1*	50	1*	50
Caterpillar	730C EJ	31	1*	45	1*	55	1*	55
Deere	260E	26	1*	45	1*	45	1*	45
Deere	300D - II	30	1*	40	1*	45	1*	45
Deere	310E	31	1*	40	1*	50	1*	50
Komatsu	HM300-5	31	1*	45	1*	55	1*	50
Terex	TA250-9	26.5	1*	50	1*	45	1*	45
Terex	TA300-9	31	1*	40	1*	55	1*	55
Volvo	A25G	27	1*	40	1*	45	1*	45
Volvo	A30D	31	1*	40	1*	50	1*	50
Volvo	A30E	31	1*	40	1*	50	1*	50
Volvo	A30G	31	1*	45	1*	50	1*	50

Pressure and ply recommendations based on normal quarry operations with standard equipment. For different applications, or modified equipment, please contact OTR Field Engineering for a specific recommendation. Tire damage or failure caused by improper load, ply, speed or inflation practices is not covered by the Titan Tire Warranty Policy.

CT - Contact Titan Technical services

875/65R29 ARTICULATED DUMP TRUCK USAGE CHART

For Standard Earthmover Service: <2.5 mile, < 30 mph



Manufacturer	Model	Payload (tons)	Front Minimum Ply Rating	Front Minimum Inflation (psi)	Middle Minimum Ply Rating	Middle Minimum Inflation (psi)	Rear Minimum Ply Rating	Rear Minimum Inflation (psi)
Bell	B40E	43	2*	50	2*	60	2*	60
Bell	B45E	45	2*	50	2*	60	2*	60
Bell	50D	50	2*	55	2*	70	2*	70
Bell	B50E	50	2*	55	2*	70	2*	70
Bell	B60E	60	2*	65	-	-	-	-
Caterpillar	740C EJ	42	2*	50	2*	65	2*	60
Caterpillar	745C	45	2*	60	2*	60	2*	55
Deere	370E	37	2*	50	2*	50	2*	50
Deere	410E	42.5	2*	50	2*	60	2*	60
Deere	460E	46	2*	55	2*	65	2*	65
Volvo	A40D	41	2*	45	2*	60	2*	60
Volvo	A40F	43	2*	45	2*	60	2*	60
Volvo	A40F-FS	43	2*	45	2*	60	2*	60
Volvo	A40G	43	2*	45	2*	60	2*	60
Volvo	A40G-FS	43	2*	50	2*	60	2*	60
Volvo	A45G	45	2*	45	2*	60	2*	60
Volvo	A45G-FS	45	2*	50	2*	60	2*	60

Pressure and ply recommendations based on normal quarry operations with standard equipment. For different applications, or modified equipment, please contact OTR Field Engineering for a specific recommendation. Tire damage or failure caused by improper load, ply, speed or inflation practices is not covered by the Titan Tire Warranty Policy.

CT - Contact Titan Technical services

RADIAL GRADER

14.00R24TG GRADER USAGE CHART

For Standard Grader Service: Unlimited distance, < 25 mph



Manufacturer	Model	Front Minimum Ply Rating	Front Minimum Inflation (psi)	Middle Minimum Ply Rating	Middle Minimum Inflation (psi)	Rear Minimum Ply Rating	Rear Minimum Inflation (psi)
Case	845B	1*	30	1*	40	1*	40
Case	865B	1*	30	1*	40	1*	40
Case	865B AWD	1*	35	1*	40	1*	40
Case	885B	1*	40	1*	45	1*	45
Case	885B AWD	1*	45	1*	45	1*	45
Caterpillar	12M	1*	35	1*	50	1*	50
Caterpillar	12M2	1*	40	1*	50	1*	50
Caterpillar	12M2 AWD	1*	45	1*	55	1*	55
Caterpillar	12M3	1*	40	1*	55	1*	55
Caterpillar	12M3 AWD	1*	45	1*	55	1*	55
Caterpillar	120M2	1*	35	1*	50	1*	50
Caterpillar	120M2 AWD	1*	35	1*	50	1*	50
Caterpillar	140	1*	35	1*	55	1*	55
Caterpillar	140H	1*	30	1*	40	1*	40
Caterpillar	140H w/ ripper	1*	30	1*	40	1*	40
Caterpillar	140M	1*	40	1*	50	1*	50
Caterpillar	140M AWD	1*	40	1*	55	1*	55
Caterpillar	140M2	1*	40	1*	55	1*	55
Caterpillar	140M2 AWD	1*	45	1*	55	1*	55
Caterpillar	140M3	1*	40	1*	55	1*	55
Caterpillar	140M3 AWD	1*	45	CT	CT	CT	CT
Caterpillar	160M	1*	40	1*	55	1*	55
Caterpillar	160M AWD	1*	45	1*	55	1*	55
Caterpillar	160M2	1*	45	1*	55	1*	55
Caterpillar	160M2 AWD	1*	50	CT	CT	CT	CT
Caterpillar	160M3	1*	45	CT	CT	CT	CT
Caterpillar	160M3 AWD	1*	50	CT	CT	CT	CT
Deere	620G/GP	1*	35	1*	50	1*	50
Deere	622G/GP	1*	35	1*	45	1*	45
Deere	622G/GP w/ ripper	1*	40	1*	50	1*	50
Deere	670G Std	1*	30	1*	45	1*	45
Deere	670G w/ ripper	1*	40	1*	50	1*	50
Deere	672G Std	1*	35	1*	45	1*	45
Deere	672G w/ ripper	1*	45	1*	55	1*	55
Deere	672GP	1*	45	1*	55	1*	55
Deere	672GP w/ ripper	1*	45	1*	50	1*	50
Deere	770C std	1*	30	1*	40	1*	40
Deere	770C w/ scarifier	1*	35	1*	40	1*	40
Deere	770C w/ ripper	1*	30	1*	45	1*	45
Deere	770CH std	1*	30	1*	40	1*	40
Deere	770CH w/ scarifier	1*	35	1*	40	1*	40
Deere	770CH w/ ripper	1*	30	1*	45	1*	45

CONTINUES ON NEXT PAGE

14.00R24TG GRADER USAGE CHART CONTINUED

For Standard Grader Service: Unlimited distance, < 25 mph



Manufacturer	Model	Front Minimum Ply Rating	Front Minimum Inflation (psi)	Middle Minimum Ply Rating	Middle Minimum Inflation (psi)	Rear Minimum Ply Rating	Rear Minimum Inflation (psi)
Deere	770G std	1*	30	1*	45	1*	45
Deere	770G w/ ripper	1*	40	1*	55	1*	55
Deere	772CH std	1*	30	1*	40	1*	40
Deere	772CH w/ scarifier	1*	40	1*	40	1*	40
Deere	772CH w/ ripper	1*	35	1*	45	1*	45
Deere	772D std	1*	30	1*	40	1*	40
Deere	772D w/ ripper	1*	35	1*	50	1*	50
Deere	772G std	1*	35	1*	45	1*	45
Deere	772G w/ ripper	1*	45	1*	55	1*	55
Deere	772GP	1*	35	1*	45	1*	45
Deere	772GP w/ ripper	1*	45	1*	55	1*	55
Deere	870G std	1*	30	1*	45	1*	45
Deere	870G w/ ripper	1*	40	1*	55	1*	55
Deere	872G std	1*	35	1*	50	1*	50
Deere	872G w/ ripper	1*	45	CT	CT	CT	CT
Terex	TG140	1*	40	1*	40	1*	40
Terex	TG180	1*	45	1*	45	1*	45
Terex	TG200	1*	50	1*	45	1*	45
Volvo	G930B	1*	30	1*	40	1*	40
Volvo	G930C	1*	30	1*	45	1*	45
Volvo	G940B	1*	35	1*	45	1*	45
Volvo	G940C	1*	35	1*	45	1*	45
Volvo	G946B	1*	35	1*	45	1*	45
Volvo	G946C	1*	35	1*	50	1*	50
Volvo	G960B	1*	35	1*	50	1*	50
Volvo	G960C	1*	35	1*	50	1*	50

Pressure and ply recommendations based on normal quarry operations with standard equipment. For different applications, or modified equipment, please contact OTR Field Engineering for a specific recommendation. Tire damage or failure caused by improper load, ply, speed or inflation practices is not covered by the Titan Tire Warranty Policy.

CT - Contact Titan Technical services

17.5R25 GRADER USAGE CHART

For Standard Grader Service: Unlimited distance, < 25 mph



Manufacturer	Model	Front Minimum Ply Rating	Front Minimum Inflation (psi)	Middle Minimum Ply Rating	Middle Minimum Inflation (psi)	Rear Minimum Ply Rating	Rear Minimum Inflation (psi)
Case	845B	1*	30	1*	40	1*	40
Case	856C	1*	30	1*	40	1*	40
Case	856C AWD	1*	30	1*	40	1*	40
Case	865B	1*	30	1*	40	1*	40
Case	865B AWD	1*	30	1*	40	1*	40
Case	885B	1*	35	1*	40	1*	40
Case	885B AWD	1*	35	1*	40	1*	40
Caterpillar	12M	1*	30	1*	40	1*	40
Caterpillar	12M2	1*	30	1*	45	1*	45

CONTINUES ON NEXT PAGE

17.5R25 GRADER USAGE CHART CONTINUED

For Standard Grader Service: Unlimited distance, < 25 mph



Manufacturer	Model	Front Minimum Ply Rating	Front Minimum Inflation (psi)	Middle Minimum Ply Rating	Middle Minimum Inflation (psi)	Rear Minimum Ply Rating	Rear Minimum Inflation (psi)
Caterpillar	12M2 AWD	1*	35	1*	45	1*	45
Caterpillar	12M3	1*	30	1*	45	1*	45
Caterpillar	12M3 AWD	1*	35	1*	45	1*	45
Caterpillar	120M2	1*	30	1*	40	1*	40
Caterpillar	120M2 AWD	1*	30	1*	45	1*	45
Caterpillar	140H	1*	30	1*	40	1*	40
Caterpillar	140M	1*	30	1*	45	1*	45
Caterpillar	140M AWD	1*	35	1*	45	1*	45
Caterpillar	140M2	1*	35	1*	45	1*	45
Caterpillar	140M2 AWD	1*	35	1*	45	1*	45
Caterpillar	140M3	1*	35	1*	45	1*	45
Caterpillar	140M3 AWD	1*	40	CT	CT	CT	CT
Caterpillar	160M	1*	35	1*	45	1*	45
Caterpillar	160M AWD	1*	35	1*	45	1*	45
Caterpillar	160M2	1*	35	1*	45	1*	45
Caterpillar	160M2 AWD	1*	40	CT	CT	CT	CT
Caterpillar	160M3	1*	35	CT	CT	CT	CT
Caterpillar	160M3 AWD	1*	40	CT	CT	CT	CT
Deere	620G/GP	1*	30	1*	40	1*	40
Deere	622G/GP	1*	30	1*	40	1*	40
Deere	622G/GP w/ ripper	1*	30	1*	45	1*	45
Deere	670G Std	1*	30	1*	40	1*	40
Deere	670G w/ ripper	1*	35	1*	45	1*	45
Deere	672G Std	1*	30	1*	40	1*	40
Deere	672G w/ ripper	1*	35	1*	45	1*	45
Deere	672GP	1*	35	1*	45	1*	45
Deere	672GP w/ ripper	1*	35	1*	40	1*	40
Deere	770C std	1*	30	1*	40	1*	40
Deere	770C w/ scarifier	1*	30	1*	40	1*	40
Deere	770C w/ ripper	1*	30	1*	40	1*	40
Deere	770CH std	1*	30	1*	40	1*	40
Deere	770CH w/ scarifier	1*	30	1*	40	1*	40
Deere	770CH w/ ripper	1*	30	1*	40	1*	40
Deere	770G std	1*	30	1*	40	1*	40
Deere	770G w/ ripper	1*	35	1*	45	1*	45
Deere	772CH std	1*	30	1*	40	1*	40
Deere	772CH w/ scarifier	1*	35	1*	40	1*	40
Deere	772CH w/ ripper	1*	30	1*	40	1*	40
Deere	772D std	1*	30	1*	40	1*	40
Deere	772D w/ ripper	1*	30	1*	40	1*	40
Deere	772G std	1*	30	1*	40	1*	40
Deere	772G w/ ripper	1*	35	1*	45	1*	45
Deere	772GP	1*	30	1*	40	1*	40
Deere	772GP w/ ripper	1*	40	1*	45	1*	45
Deere	870G std	1*	30	1*	40	1*	40
Deere	870G w/ ripper	1*	35	1*	45	1*	45

CONTINUES ON NEXT PAGE

17.5R25 GRADER USAGE CHART CONTINUED							
For Standard Grader Service: Unlimited distance, < 25 mph							
Manufacturer	Model	Front Minimum Ply Rating	Front Minimum Inflation (psi)	Middle Minimum Ply Rating	Middle Minimum Inflation (psi)	Rear Minimum Ply Rating	Rear Minimum Inflation (psi)
Deere	872G std	1*	30	1*	40	1*	40
Deere	872G w/ ripper	1*	40	CT	CT	CT	CT
Komatsu	GD655-5	1*	30	1*	40	1*	40
Komatsu	GD655-5 w/ ripper	1*	30	1*	40	1*	40
Komatsu	GD655-5 w/ scarifier	1*	30	1*	40	1*	40
Komatsu	GD655-6	1*	30	1*	40	1*	40
Komatsu	GD655-6 w/ ripper	1*	30	1*	45	1*	45
Komatsu	GD655-6 w/ scaifier	1*	30	1*	40	1*	40
Komatsu	GD655-7	1*	30	1*	40	1*	40
Volvo	G930B	1*	30	1*	40	1*	40
Volvo	G930C	1*	30	1*	45	1*	45
Volvo	G940B	1*	30	1*	40	1*	40
Volvo	G940C	1*	30	CT	CT	CT	CT
Volvo	G946B	1*	30	1*	40	1*	40
Volvo	G946C	1*	30	CT	CT	CT	CT
Volvo	G960B	1*	30	1*	40	1*	40
Volvo	G960C	1*	35	CT	CT	CT	CT

20.5R25 GRADER USAGE CHART							
For Standard Grader Service: Unlimited distance, < 25 mph							
Manufacturer	Model	Front Minimum Ply Rating	Front Minimum Inflation (psi)	Middle Minimum Ply Rating	Middle Minimum Inflation (psi)	Rear Minimum Ply Rating	Rear Minimum Inflation (psi)
Caterpillar	14M	1*	30	1*	45	1*	45
Caterpillar	14M3	1*	30	CT	CT	CT	CT

29.5R29 GRADER USAGE CHART							
For Standard Grader Service: Unlimited distance, < 25 mph							
Manufacturer	Model	Front Minimum Ply Rating	Front Minimum Inflation (psi)	Middle Minimum Ply Rating	Middle Minimum Inflation (psi)	Rear Minimum Ply Rating	Rear Minimum Inflation (psi)
Caterpillar	24M	1*	45	1*	60	1*	60
Caterpillar	24	1*	50	CT	CT	CT	CT

Pressure and ply recommendations based on normal quarry operations with standard equipment. For different applications, or modified equipment, please contact OTR Field Engineering for a specific recommendation. Tire damage or failure caused by improper load, ply, speed or inflation practices is not covered by the Titan Tire Warranty Policy.

CT - Contact Titan Technical services

RADIAL LOADER

17.5R25 LOADER USAGE CHART

For Standard Loader Service: <250 ft, < 5 mph



Manufacturer	Model	Bucket (cu. yd.)	Front Minimum Ply Rating	Front Minimum Inflation (psi)	Rear Minimum Ply Rating	Rear Minimum Inflation (psi)	Manufacturer	Model	Bucket (cu. yd.)	Front Minimum Ply Rating	Front Minimum Inflation (psi)	Rear Minimum Ply Rating	Rear Minimum Inflation (psi)
Caterpillar	IT14B	1.6	1*	60	1*	60	Case	521G Z-Bar	2	1*	65	1*	60
Caterpillar	IT14F	1.6	1*	60	1*	60	Case	521G Z-Bar	2.3	1*	70	1*	60
Caterpillar	IT14G	1.7	1*	60	1*	60	Case	521G XR	2.1	1*	70	1*	60
Caterpillar	IT18	1.5	1*	60	1*	60	Case	521G XR	2	1*	65	1*	60
Caterpillar	IT18B	1.75	1*	60	1*	60	Case	521G XR	2.3	1*	70	1*	60
Caterpillar	IT18F	2	1*	65	1*	60	Case	521G XT	2.1	1*	70	1*	60
Caterpillar	IT24	2.3	1*	65	1*	60	Case	521G XT	2	1*	70	1*	60
Caterpillar	IT24F	2.4	1*	75	1*	60	Case	621	2.2	1*	70	1*	60
Caterpillar	IT28	2	1*	65	1*	60	Daewoo	Mega 200	2.4	1*	70	1*	60
Caterpillar	IT28B	2.25	1*	70	1*	60	Daewoo	Mega 200-III	2.3	1*	70	1*	60
Caterpillar	IT28F	2.6	1*	75	1*	60	Deere	304H	1.25	1*	60	1*	60
Caterpillar	910M	2.5	1*	65	1*	60	Deere	304H WH	1	1*	60	1*	60
Caterpillar	914G	1.7	1*	60	1*	60	Deere	324H	1.75	1*	60	1*	60
Caterpillar	914G2	1.8	1*	60	1*	60	Deere	344E	1.6	1*	60	1*	60
Caterpillar	914K	1.7	1*	60	1*	60	Deere	344G	1.6	1*	60	1*	60
Caterpillar	914K HL	1.7	1*	60	1*	60	Deere	344H	2	1*	60	1*	60
Caterpillar	914M	2.5	1*	65	1*	60	Deere	344K	1.75	1*	60	1*	60
Caterpillar	916	2	1*	60	1*	60	Deere	344L	2	1*	60	1*	60
Caterpillar	918F	2	1*	60	1*	60	Deere	344L HL	2	1*	65	1*	60
Caterpillar	918M	2.5	1*	70	1*	60	Deere	444	1.5	1*	60	1*	60
Caterpillar	924F	2.25	1*	65	1*	60	Deere	444C	1.75	1*	60	1*	60
Caterpillar	924Gz	2.3	1*	65	1*	60	Deere	444D	1.75	1*	60	1*	60
Caterpillar	924K	2.5	1*	85	1*	60	Deere	444E	1.75	1*	60	1*	60
Caterpillar	926	1.75	1*	60	1*	60	Deere	444G	1.75	1*	60	1*	60
Caterpillar	926E	2.25	1*	65	1*	60	Deere	444H	2.5	1*	70	1*	60
Caterpillar	926M	2.5	1*	85	1*	60	Deere	444H HL	2.5	1*	75	1*	60
Caterpillar	928F	2.6	1*	75	1*	60	Deere	444K Z-bar	2.5	1*	75	1*	60
Caterpillar	928G	2.6	1*	75	1*	60	Deere	444K HL	2.5	1*	80	1*	60
Caterpillar	930	2.25	1*	65	1*	60	Deere	444K Powerllel	2.5	1*	85	1*	60
Caterpillar	936	2.75	1*	85	1*	60	Deere	544B	1.75	1*	60	1*	60
Caterpillar	936E	3	1*	90	1*	60	Deere	544C	2	1*	65	1*	60
Caterpillar	936F	3	1*	90	1*	60	Deere	544D	2.2	1*	65	1*	60
Case	W14C	1.7	1*	60	1*	60	Deere	544E	2.2	1*	65	1*	60
Case	W18	2	1*	60	1*	60	Deere	544G	2.5	1*	70	1*	60
Case	W18B	2	1*	60	1*	60	Deere	544G-TC	2.5	1*	75	1*	60
Case	W20	2	1*	65	1*	60	Deere	TC44H	2	1*	60	1*	60
Case	W20B	2.5	1*	70	1*	60	Deere	TC54H	2.5	1*	65	1*	60
Case	W20C	2	1*	60	1*	60	Deere	TC62H	3	1*	70	1*	60
Case	W24B	2.5	1*	70	1*	60	Fiatallis	FR7B	1.4	1*	60	1*	60
Case	W24C	3	1*	80	1*	60	Fiatallis	FR7C	1.4	1*	60	1*	60
Case	521D	2	1*	60	1*	60	Fiatallis	FR70	1.4	1*	60	1*	60
Case	521G Z-Bar	2.1	1*	65	1*	60							

CONTINUES ON NEXT PAGE

17.5R25 LOADER USAGE CHART CONTINUED

For Standard Loader Service: <250 ft, < 5 mph



Manufacturer	Model	Bucket (cu. yd.)	Front Minimum Ply Rating	Front Minimum Inflation (psi)	Rear Minimum Ply Rating	Rear Minimum Inflation (psi)
Fiatallis	345B	1.5	1*	60	1*	60
Fiatallis	FR9B PL	1.7	1*	60	1*	60
Fiatallis	FR90 PL	1.8	1*	60	1*	60
Fiatallis	FR9B	1.8	1*	60	1*	60
Fiatallis	FR9C	1.8	1*	60	1*	60
Fiatallis	FR90	1.8	1*	60	1*	60
Fiatallis	FR10	2	1*	60	1*	60
Fiatallis	FR10B	2.2	1*	65	1*	60
Fiatallis	FR10C	2.25	1*	65	1*	60
Fiatallis	FR100	2.25	1*	65	1*	60
Fiatallis	FR11	2.5	1*	75	1*	60
Fiatallis	FR12	2.5	1*	75	1*	60
Fiatallis	FR12B	2.5	1*	70	1*	60
Fiatallis	FR120	2.5	1*	70	1*	60
Fiatallis	FR120-2	2.5	1*	75	1*	60
Fiatallis	FW130	2.75	1*	80	1*	60
Fiatallis	FW110	2.2	1*	65	1*	60
Fiat Hitachi	W110	2.1	1*	60	1*	60
Fiat Hitachi	W130 PL	2.6	1*	75	1*	60
Furukawa	FL120-I	1.7	1*	60	1*	60
Furukawa	FL120A-I	1.7	1*	60	1*	60
Hitachi	ZW120	2	1*	60	1*	60
Hitachi	ZW120 HL	1.75	1*	60	1*	60
Hitachi	ZW120-6	2	1*	60	1*	60
Hitachi	ZW120-6 HL	2	1*	60	1*	60
Hitachi	ZW140	2.6	1*	70	1*	60
Hitachi	ZW140 HL	2	1*	65	1*	60
Hitachi	ZW140-6	2.7	1*	75	1*	60
Hitachi	ZW140-6 HL	2.7	1*	80	1*	60
Hyundai	HL17	2.4	1*	75	1*	60
Hyundai	HL730-9A	2.5	1*	70	1*	60
Hyundai	HL730XTD-9A	2.5	1*	75	1*	60
Hyundai	HL730TM-9A	2.2	1*	70	1*	60
Hyundai	HL740-9A	3	1*	90	1*	60
Hyundai	HL740XTD-9A	3	2*	CT	1*	60
Hyundai	HL740TM-9A	3	2*	CT	1*	65
Hyundai	HL757-9A	3.7	2*	CT	1*	65
Hyundai	HL757XTD-9A	3.7	CT	CT	1*	75
Hyundai	HL757TM-9A	3.5	CT	CT	1*	70
Hyundai	HL940	3	1*	90	1*	60
Hyundai	HL940 XT	3	2*	CT	1*	60
Hyundai	HL955	3.1	2*	CT	1*	60
Hyundai	HL955 XTD	3.1	2*	CT	1*	65
JCB	411HT	1.6	1*	60	1*	60
JCB	416HT	2.2	1*	65	1*	60

Manufacturer	Model	Bucket (cu. yd.)	Front Minimum Ply Rating	Front Minimum Inflation (psi)	Rear Minimum Ply Rating	Rear Minimum Inflation (psi)
JCB	417HT	2	1*	60	1*	60
JCB	417HT HL	2	1*	60	1*	60
JCB	417HT SHL	2	1*	70	1*	60
Kawasaki	50ZIV	1.7	1*	60	1*	60
Kawasaki	50ZIV-2	2	1*	60	1*	60
Kawasaki	60Z	2.1	1*	60	1*	60
Kawasaki	60ZII	2.1	1*	60	1*	60
Kawasaki	60ZIII	2.1	1*	60	1*	60
Kawasaki	60ZIV	2.1	1*	60	1*	60
Kawasaki	60ZIV-2	2.5	1*	65	1*	60
Kawasaki	60Z7	2	1*	60	1*	60
Kawasaki	60ZV-2	2.2	1*	60	1*	60
Kawasaki	60ZV-2 HL	2.2	1*	65	1*	60
Kawasaki	60ZV-2 SHL	2.2	1*	70	1*	60
Kawasaki	62Z7	2.75	1*	75	1*	60
Kawasaki	65TM-2	2.6	2*	CT	1*	60
Kawasaki	65Z	2.3	1*	65	1*	60
Kawasaki	65ZII	2.3	1*	65	1*	60
Kawasaki	65ZIII	2.6	1*	70	1*	60
Kawasaki	65ZIV	2.6	1*	75	1*	60
Kawasaki	65ZIV-2	3	1*	80	1*	60
Kawasaki	65ZV-2	3	1*	80	1*	60
Kawasaki	65ZV-2 HL	2.8	1*	80	1*	60
Kawasaki	65ZV-2 SHL	2.8	1*	85	1*	60
Komatsu	WA120-1	1.75	1*	60	1*	60
Komatsu	WA120-3	1.85	1*	60	1*	60
Komatsu	WA150-5	2	1*	60	1*	60
Komatsu	WA180-1	2.25	1*	65	1*	60
Komatsu	WA180-3	2.9	1*	75	1*	60
Komatsu	WA180-3 PTC	2.5	1*	70	1*	60
Komatsu	WA200-5	2.6	1*	70	1*	60
Komatsu	WA200-6	2.6	1*	70	1*	60
Komatsu	WA200PZ-6	2.6	1*	75	1*	60
Komatsu	WA200-7	2.6	1*	75	1*	60
Komatsu	WA200-8	2.6	1*	75	1*	60
Komatsu	WA250-5	3	1*	80	1*	60
Komatsu	WA250-6	3	1*	75	1*	60
Komatsu	WA250PZ-6	2.9	1*	85	1*	60
Komatsu Dresser	512	1.7	1*	60	1*	60
Komatsu Dresser	515B	1.6	1*	60	1*	60
Komatsu Dresser	515C	2	1*	60	1*	60
Komatsu Dresser	515CH	2	1*	60	1*	60

CONTINUES ON NEXT PAGE

17.5R25 LOADER USAGE CHART CONTINUED

For Standard Loader Service: <250 ft, < 5 mph



Manufacturer	Model	Bucket (cu. yd.)	Front Minimum Ply Rating	Front Minimum Inflation (psi)	Rear Minimum Ply Rating	Rear Minimum Inflation (psi)
Komatsu Dresser	518	2.2	1*	65	1*	60
Komatsu Dresser	520B	2.25	1*	65	1*	60
Komatsu Dresser	520C	2.5	1*	70	1*	60
Liebherr	L524 Z-bar	2.7	1*	75	1*	60
Liebherr	L524	2.4	1*	75	1*	60
Liebherr	L524 HL	2.4	1*	80	1*	60
Liebherr	L526 Z-bar	2.75	1*	75	1*	60
Liebherr	L526	2.75	1*	85	1*	60
Liebherr	L526 HL	2.75	1*	90	1*	60
Liebherr	L528 Z-bar	3	1*	80	1*	60
Liebherr	L528	2.7	1*	80	1*	60
Liebherr	L528 HL	2.7	1*	90	1*	60
Terex	33C	1.75	1*	60	1*	60
Terex	44C	2.25	1*	75	1*	60
Volvo	L45H	2	1*	60	1*	60
Volvo	L50C	2	1*	60	1*	60
Volvo	L50D	2	1*	60	1*	60
Volvo	L50H	2.1	1*	65	1*	60
Volvo	L60G	2.75	1*	80	1*	60
Volvo	L60H	2.75	1*	75	1*	60
Volvo	L70B	2.1	1*	65	1*	60
Volvo	L70C	2.5	1*	70	1*	60
Volvo	L70D	2.5	1*	75	1*	60

For service under chains, or load and carry operations, contact Titan Technical Services.

Pressure and ply recommendations based on normal quarry operations with standard equipment. For different applications, or modified equipment, please contact OTR Field Engineering for a specific recommendation. Tire damage or failure caused by improper load, ply, speed or inflation practices is not covered by the Titan Tire Warranty Policy.

CT - Contact Titan Technical services
HL - High Lift, extended booms, etc.

20.5R25 LOADER USAGE CHART

For Standard Loader Service: <250 ft, < 5 mph



Manufacturer	Model	Bucket (cu. yd.)	Front Minimum Ply Rating	Front Minimum Inflation (psi)	Rear Minimum Ply Rating	Rear Minimum Inflation (psi)	Manufacturer	Model	Bucket (cu. yd.)	Front Minimum Ply Rating	Front Minimum Inflation (psi)	Rear Minimum Ply Rating	Rear Minimum Inflation (psi)
Caterpillar	IT38F	3.25	1*	70	1*	60	Case	621G XT	2.8	1*	65	1*	60
Caterpillar	IT38G	3.3	1*	70	1*	60	Case	721	2.75	1*	60	1*	60
Caterpillar	IT38H	3.3	1*	80	1*	60	Case	721B	2.75	1*	60	1*	60
Caterpillar	924G	2.3	1*	60	1*	60	Case	721B XT	2.75	1*	65	1*	60
Caterpillar	924H	2.4	1*	60	1*	60	Case	721C	2.75	1*	65	1*	60
Caterpillar	924Hz	2.3	1*	60	1*	60	Case	721E	3.5	1*	70	1*	60
Caterpillar	924K	2.5	1*	65	1*	60	Case	721E XT	3	1*	65	1*	60
Caterpillar	926M	2.5	1*	65	1*	60	Case	721E XR	3	1*	70	1*	60
Caterpillar	928Hz	2.6	1*	60	1*	60	Case	721F	3	1*	65	1*	60
Caterpillar	930H	2.7	1*	60	1*	60	Case	721F XT	3	1*	70	1*	60
Caterpillar	930K	2.75	1*	65	1*	60	Case	721F XR	3	1*	70	1*	60
Caterpillar	930M	2.75	1*	70	1*	60	Case	721G Z-Bar	3	1*	65	1*	60
Caterpillar	930M HL	2.7	1*	70	1*	60	Case	721G Z-Bar	2.8	1*	65	1*	60
Caterpillar	936F TC	3	1*	65	1*	60	Case	721G Z-Bar	3.25	1*	70	1*	60
Caterpillar	938F	3.25	1*	70	1*	60	Case	721G XR	3	1*	70	1*	60
Caterpillar	938G	3.25	1*	70	1*	60	Case	721G XR	2.8	1*	70	1*	60
Caterpillar	938H	3.65	1*	80	1*	60	Case	721G XR	3.25	1*	75	1*	60
Caterpillar	938K	3.25	1*	75	1*	60	Case	721G XT	3	1*	70	1*	60
Caterpillar	938M	3.25	1*	80	1*	60	Case	721G XT	2.8	1*	70	1*	60
Caterpillar	950B	3.75	1*	85	1*	60	Case	W30	3.5	1*	65	1*	60
Caterpillar	950F	4	1*	90	1*	60	Daewoo	Mega 250-III	3.1	1*	70	1*	60
Case	521G Z-Bar	2.1	1*	60	1*	60	Deere	444K Z-bar	2.5	1*	60	1*	60
Case	521G Z-Bar	2	1*	60	1*	60	Deere	444K HL	2.5	1*	60	1*	60
Case	521G Z-Bar	2.3	1*	60	1*	60	Deere	444K Powerllec	2.5	1*	60	1*	60
Case	521G XR	2.1	1*	60	1*	60	Deere	524K	2.75	1*	60	1*	60
Case	521G XR	2	1*	60	1*	60	Deere	524K HL	2.75	1*	60	1*	60
Case	521G XR	2.3	1*	60	1*	60	Deere	524L	2.75	1*	60	1*	60
Case	521G XT	2.1	1*	60	1*	60	Deere	524L HL	2.75	1*	65	1*	60
Case	521G XT	2	1*	60	1*	60	Deere	544H	3	1*	65	1*	60
Case	621B	2.25	1*	60	1*	60	Deere	544H HL	3	1*	65	1*	60
Case	621B	3	1*	65	1*	60	Deere	544J	3	1*	65	1*	60
Case	621B XT	2.25	1*	60	1*	60	Deere	544J HL	3	1*	65	1*	60
Case	621D	2.5	1*	60	1*	60	Deere	544K	3	1*	65	1*	60
Case	621E	3	1*	65	1*	60	Deere	544K HL	3	1*	65	1*	60
Case	621E XT	3	1*	65	1*	60	Deere	544L	3	1*	65	1*	60
Case	621E XR	3	1*	65	1*	60	Deere	544L HL	2.75	1*	65	1*	60
Case	621G Z-Bar	2.5	1*	60	1*	60	Deere	624E	2.6	1*	60	1*	60
Case	621G Z-Bar	2.4	1*	60	1*	60	Deere	624G	3.25	1*	70	1*	60
Case	621G Z-Bar	2.75	1*	60	1*	60	Deere	624H	3.5	1*	70	1*	60
Case	621G XR	2.5	1*	60	1*	60	Deere	624H HL	3	1*	70	1*	60
Case	621G XR	2.4	1*	60	1*	60	Deere	624K	3.5	1*	75	1*	60
Case	621G XR	2.75	1*	65	1*	60	Deere	624K HL	3.5	1*	75	1*	60
Case	621G XT	2.5	1*	60	1*	60	Deere	624L	3.5	1*	75	1*	60
Case	621G XT	2.4	1*	60	1*	60	Deere	624L HL	3.5	1*	80	1*	60
Case	621G XT	3	1*	70	1*	60	Deere	644B	2.5	1*	60	1*	60

CONTINUES ON NEXT PAGE

20.5R25 LOADER USAGE CHART CONTINUED

For Standard Loader Service: <250 ft, < 5 mph



Manufacturer	Model	Bucket (cu. yd.)	Front Minimum Ply Rating	Front Minimum Inflation (psi)	Rear Minimum Ply Rating	Rear Minimum Inflation (psi)	Manufacturer	Model	Bucket (cu. yd.)	Front Minimum Ply Rating	Front Minimum Inflation (psi)	Rear Minimum Ply Rating	Rear Minimum Inflation (psi)
Deere	644C	3	1*	65	1*	60	Hyundai	HL740-7A	2.7	1*	60	1*	60
Doosan	DL200	2.6	1*	60	1*	60	Hyundai	HL740TM-7A	2.6	1*	60	1*	60
Doosan	DL200TC	2.6	1*	60	1*	60	Hyundai	HL740XTD-7A	2.7	1*	60	1*	60
Doosan	DL200-5	2.6	1*	60	1*	60	Hyundai	HL740-9A	3	1*	70	1*	60
Doosan	DL200-5 HL	2.6	1*	60	1*	60	Hyundai	HL740XTD-9A	3	1*	70	1*	60
Doosan	DL200TC-5	2.6	1*	60	1*	60	Hyundai	HL740TM-9A	3	1*	75	1*	60
Doosan	DL220-5	3	1*	65	1*	60	Hyundai	HL750	3	1*	65	1*	60
Doosan	DL220-5 HL	3	1*	65	1*	60	Hyundai	HL757-7A	3.5	1*	75	1*	60
Doosan	DL250	3.3	1*	70	1*	60	Hyundai	HL757TM-7A	3.3	1*	80	1*	60
Doosan	DL250TC	3.4	1*	75	1*	60	Hyundai	HL757XTD-7A	3.5	1*	80	1*	60
Doosan	DL250HL	3.4	1*	75	1*	60	Hyundai	HL757-9A	3.7	1*	80	1*	60
Doosan	DL250-5	3.3	1*	70	1*	60	Hyundai	HL757XTD-9A	3.7	1*	85	1*	60
Doosan	DL250-5 HL	3.3	1*	75	1*	60	Hyundai	HL757TM-9A	3.5	1*	85	1*	60
Doosan	DL250TC-5	3.3	1*	75	1*	60	Hyundai	HL760-9A	4.3	2*	CT	1*	60
Doosan	DL280-5	3.7	1*	80	1*	60	Hyundai	HL760XTD-9A	4.3	2*	CT	1*	60
Doosan	DL280-5 HL	3.7	1*	85	1*	60	Hyundai	HL940	3	1*	65	1*	60
Dressta	520E	2.3	1*	60	1*	60	Hyundai	HL940 XT	3	1*	70	1*	60
Fiattalis	FR130	3	1*	65	1*	60	Hyundai	HL955	3.1	1*	70	1*	60
Fiattalis	FR130-2	3	1*	65	1*	60	Hyundai	HL955 XTD	3.1	1*	75	1*	60
Fiattalis	FR140	3	1*	65	1*	60	Hyundai	HL960	3.8	1*	90	1*	60
Fiattalis	FR140-2	3.25	1*	70	1*	60	Hyundai	HL960 XT	3.8	1*	90	1*	60
Fiattalis	FR15	3	1*	70	1*	60	JCB	417HT	2	1*	60	1*	60
Fiattalis	FR15B	3.1	1*	70	1*	60	JCB	417HT HL	2	1*	60	1*	60
Fiat Hitachi	W170 PL	3.9	1*	80	1*	60	JCB	417HT SHL	2	1*	60	1*	60
Furukawa	FL150-I	2	1*	60	1*	60	JCB	426HT	2.5	1*	60	1*	60
Furukawa	FL200-I	2.6	1*	60	1*	60	JCB	426HT	2.75	1*	65	1*	60
Furukawa	FL230-I	3.1	1*	70	1*	60	JCB	426ZX	2.5	1*	60	1*	60
Hitachi	ZW140-5	3	1*	60	1*	60	JCB	426ZX	2.75	1*	60	1*	60
Hitachi	ZW140-5 HL	2.1	1*	60	1*	60	JCB	436HT	3.5	1*	75	1*	60
Hitachi	ZW140-6	2.7	1*	60	1*	60	JCB	436ZX	3.5	1*	75	1*	60
Hitachi	ZW140-6 HL	2.7	1*	65	1*	60	JCB	456HT	4.6	2*	CT	1*	70
Hitachi	ZW150	3	1*	60	1*	60	Kawasaki	62Z7	2.75	1*	60	1*	60
Hitachi	ZW150 HL	2.6	1*	60	1*	60	Kawasaki	62Z7 HL	2.75	1*	60	1*	60
Hitachi	ZW150-5	3.3	1*	65	1*	60	Kawasaki	65ZV-2	3	1*	60	1*	60
Hitachi	ZW150-5 HL	2.6	1*	60	1*	60	Kawasaki	65TMV-2	2.5	1*	60	1*	60
Hitachi	ZW150-6	3.1	1*	65	1*	60	Kawasaki	67Z7	3.1	1*	65	1*	60
Hitachi	ZW150-6 HL	3.1	1*	70	1*	60	Kawasaki	67Z7 HL	3.1	1*	65	1*	60
Hitachi	ZW150PL-6	2.7	1*	60	1*	60	Kawasaki	70Z	3	1*	65	1*	60
Hitachi	ZW180	3.6	1*	75	1*	60	Kawasaki	70ZII	3	1*	65	1*	60
Hitachi	ZW180 HL	3.1	1*	75	1*	60	Kawasaki	70ZIII	3.25	1*	65	1*	60
Hitachi	ZW180-5	3.7	1*	75	1*	60	Kawasaki	70ZIV	3.25	1*	70	1*	60
Hitachi	ZW180-5 HL	3.1	1*	75	1*	60	Kawasaki	70ZIV-2	3.5	1*	70	1*	60
Hitachi	ZW180-6	3.7	1*	75	1*	60	Kawasaki	70ZV-2	3.5	1*	70	1*	60
Hitachi	ZW180-6 HL	3.7	1*	80	1*	60	Kawasaki	70TMV-2	3.4	1*	80	1*	60
Hyundai	HL25	3.5	1*	80	1*	60	Kawasaki	70Z7	3.7	1*	75	1*	60

CONTINUES ON NEXT PAGE

20.5R25 LOADER USAGE CHART CONTINUED

For Standard Loader Service: <250 ft, < 5 mph



Manufacturer	Model	Bucket (cu. yd.)	Front Minimum Ply Rating	Front Minimum Inflation (psi)	Rear Minimum Ply Rating	Rear Minimum Inflation (psi)
Kawasaki	70Z7 HL	3.7	1*	80	1*	60
Kawasaki	80ZV-2	4.2	1*	90	1*	60
Komatsu	WA200-5	2.6	1*	60	1*	60
Komatsu	WA200-6	2.6	1*	60	1*	60
Komatsu	WA200PZ-6	2.5	1*	60	1*	60
Komatsu	WA200-7	2.6	1*	60	1*	60
Komatsu	WA200-8	2.6	1*	60	1*	60
Komatsu	WA250-1	3	1*	60	1*	60
Komatsu	WA250-3	3.5	1*	65	1*	60
Komatsu	WA250-3 PTC	3	1*	65	1*	60
Komatsu	WA250-5	3	1*	60	1*	60
Komatsu	WA250-6	3	1*	60	1*	60
Komatsu	WA250PZ-6	3	1*	65	1*	60
Komatsu	WA270-7	3	1*	65	1*	60
Komatsu	WA270-8	3	1*	65	1*	60
Komatsu	WA320-1	3.25	1*	70	1*	60
Komatsu	WA320-3	4.2	1*	80	1*	60
Komatsu	WA320-6	3.7	1*	75	1*	60
Komatsu	WA320PZ-6	3.5	1*	80	1*	60
Komatsu	WA320-7	3.7	1*	80	1*	60
Komatsu	WA320-8	3.7	1*	80	1*	60
Komatsu Dresser	520CH	2.5	1*	60	1*	60
Komatsu Dresser	525	2.7	1*	60	1*	60
Komatsu Dresser	530	3	1*	65	1*	60
Komatsu Dresser	530C	3	1*	65	1*	60
Komatsu Dresser	532	3.2	1*	70	1*	60
Liebherr	L538 Z-bar	3.4	1*	70	1*	60
Liebherr	L538	3	1*	65	1*	60
Liebherr	L538 HL	3	1*	70	1*	60
Liebherr	L542 Z-bar	3.7	1*	75	1*	60
Liebherr	L542	3.3	1*	70	1*	60
Liebherr	L542 HL	3.3	1*	75	1*	60
Liebherr	L546 Z-bar	3.6	1*	75	1*	60
Liebherr	L546	3.25	1*	70	1*	60
Liebherr	L546 HL	3.25	1*	75	1*	60
New Holland	W170B	3	1*	65	1*	60
New Holland	W170B TC/LR	3	1*	65	1*	60
Terex	55C	3	1*	65	1*	60
Terex	TL210	4.6	1*	85	1*	60
Terex	TL260	5.9	2*	CT	1*	70
Volvo	L60F	2.7	1*	60	1*	60

Manufacturer	Model	Bucket (cu. yd.)	Front Minimum Ply Rating	Front Minimum Inflation (psi)	Rear Minimum Ply Rating	Rear Minimum Inflation (psi)
Volvo	L60G	2.75	1*	60	1*	60
Volvo	L60H	2.75	1*	60	1*	60
Volvo	L70B	2.1	1*	60	1*	60
Volvo	L70C	2.5	1*	60	1*	60
Volvo	L70D	2.5	1*	60	1*	60
Volvo	L70F	3	1*	65	1*	60
Volvo	L70G	3	1*	65	1*	60
Volvo	L70H	3	1*	70	1*	60
Volvo	L90B	3	1*	65	1*	60
Volvo	L90C	3.5	1*	75	1*	60
Volvo	L90D	3.5	1*	80	1*	60
Volvo	L90E	3.25	1*	75	1*	60
Volvo	L90F	3.5	1*	80	1*	60
Volvo	L90G	3.25	1*	75	1*	60
Volvo	L90H	3.25	1*	75	1*	60

For service under chains, or load and carry operations, contact Titan Technical Services.

Pressure and ply recommendations based on normal quarry operations with standard equipment. For different applications, or modified equipment, please contact OTR Field Engineering for a specific recommendation. Tire damage or failure caused by improper load, ply, speed or inflation practices is not covered by the Titan Tire Warranty Policy.

CT - Contact Titan Technical services
HL - High Lift, extended booms, etc.

23.5R25 LOADER USAGE CHART CONTINUED

For Standard Loader Service: <250 ft, < 5 mph



Manufacturer	Model	Bucket (cu. yd.)	Front Minimum Ply Rating	Front Minimum Inflation (psi)	Rear Minimum Ply Rating	Rear Minimum Inflation (psi)	Manufacturer	Model	Bucket (cu. yd.)	Front Minimum Ply Rating	Front Minimum Inflation (psi)	Rear Minimum Ply Rating	Rear Minimum Inflation (psi)
Hitachi	ZW250-6 HL	4.8	1*	85	1*	60	Komatsu	WA380-6	4.3	1*	70	1*	60
Hyundai	HL760	4	1*	70	1*	60	Komatsu	WA380-7	4.3	1*	70	1*	60
Hyundai	HL760-7A	4	1*	70	1*	60	Komatsu	WA380-7 HL	3.8	1*	70	1*	60
Hyundai	HL760XTD-7A	4	1*	75	1*	60	Komatsu	WA380-8	4.3	1*	70	1*	60
Hyundai	HL760-9	4.3	1*	70	1*	60	Komatsu	WA380-8 HL	3.8	1*	70	1*	60
Hyundai	HL760XTD-9	4.3	1*	75	1*	60	Komatsu	WA430-6	4.6	1*	75	1*	60
Hyundai	HL760-9A	4.3	1*	70	1*	60	Komatsu Dresser	538	4	1*	70	1*	60
Hyundai	HL760XTD-9A	4.3	1*	75	1*	60	Komatsu Dresser	540	4.5	1*	70	1*	60
Hyundai	HL770-7	5.2	1*	90	1*	60	Liebherr	L550	4.2	1*	70	1*	60
Hyundai	HL770XTD-7	5.2	2*	CT	1*	60	Liebherr	L550 HL	3.4	1*	70	1*	60
Hyundai	HL770-7A	4	1*	75	1*	60	Liebherr	L550XP	4.2	1*	70	1*	60
Hyundai	HL770XTD-7A	4	1*	80	1*	60	Liebherr	L550XP HL	3.4	1*	70	1*	60
Hyundai	HL770-9	5.5	2*	CT	1*	60	Liebherr	L556	4.7	1*	75	1*	60
Hyundai	HL770XTD-9	5.5	2*	CT	1*	60	Liebherr	L556 HL	3.7	1*	70	1*	60
Hyundai	HL770-9A	5.5	2*	CT	1*	60	Liebherr	L556XP	4.7	1*	75	1*	60
Hyundai	HL770XTD-9A	5.5	2*	CT	1*	60	Liebherr	L556XP HL	3.7	1*	75	1*	60
Hyundai	HL960	3.8	1*	70	1*	60	New Holland	W190B	3.44	1*	60	1*	60
Hyundai	HL960 XT	3.8	1*	70	1*	60	New Holland	W190B LR	3.44	1*	65	1*	60
Hyundai	HL970	4.7	1*	85	1*	60	Terex	66C	4	1*	75	1*	60
Hyundai	HL970 XTD	4.7	1*	90	1*	60	Terex	70C	4.4	1*	75	1*	60
Hyundai	HL35	4.8	1*	85	1*	60	Terex	TL310	4	1*	70	1*	60
JCB	456ZX	4.3	1*	75	1*	60	Volvo	L110F	4.4	1*	75	1*	60
JCB	457HT	4.1	1*	75	1*	60	Volvo	L110G	4.5	1*	75	1*	60
JCB	457HT SHL	4.1	1*	85	1*	60	Volvo	L110H	4	1*	70	1*	60
JCB	457ZX	4.1	1*	70	1*	60	Volvo	L120B	3.9	1*	60	1*	60
JCB	457ZX HL	4.1	1*	80	1*	60	Volvo	L120C	4.7	1*	75	1*	60
Kawasaki	70ZV-2	3.5	1*	60	1*	60	Volvo	L120D	4.7	1*	80	1*	60
Kawasaki	70ZV-2 HL	3.5	1*	60	1*	60	Volvo	L120F	4.7	1*	80	1*	60
Kawasaki	70TMV-2	3.4	1*	65	1*	60	Volvo	L120G	4.5	1*	75	1*	60
Kawasaki	70Z7	3.7	1*	60	1*	60	Volvo	L120H	4.25	1*	75	1*	60
Kawasaki	70Z7 HL	3.7	1*	65	1*	60	Volvo	L150	4.5	1*	80	1*	60
Kawasaki	80Z	3.75	1*	65	1*	60	Volvo	L150C	5.2	1*	85	1*	60
Kawasaki	80ZII	3.75	1*	65	1*	60	Volvo	L150D	5.2	2*	CT	1*	60
Kawasaki	80ZIII	3.75	1*	65	1*	60							
Kawasaki	80ZIV	3.75	1*	65	1*	60							
Kawasaki	80ZIV-2	4	1*	65	1*	60							
Kawasaki	80ZV-2	4.2	1*	70	1*	60							
Kawasaki	80Z7	4.2	1*	70	1*	60							
Kawasaki	80Z7 HL	4.2	1*	75	1*	60							
Kawasaki	85Z7	4.8	1*	80	1*	60							
Kawasaki	85Z7 HL	4.8	1*	85	1*	60							
Kawasaki	90Z7	5.5	2*	CT	1*	60							
Kawasaki	90Z7 HL	5.5	2*	CT	1*	65							
Kawasaki	90Z7B	5.5	2*	CT	1*	60							
Kawasaki	90Z7B HL	5.5	2*	CT	1*	65							
Komatsu	WA380-3	5.25	1*	80	1*	60							

For service under chains, or load and carry operations, contact Titan Technical Services.

Pressure and ply recommendations based on normal quarry operations with standard equipment. For different applications, or modified equipment, please contact OTR Field Engineering for a specific recommendation. Tire damage or failure caused by improper load, ply, speed or inflation practices is not covered by the Titan Tire Warranty Policy.

CT - Contact Titan Technical services
HL - High Lift, extended booms, etc.

26.5R25 LOADER USAGE CHART

For Standard Loader Service: <250 ft, < 5 mph



Manufacturer	Model	Bucket (cu. yd.)	Front Minimum Ply Rating	Front Minimum Inflation (psi)	Rear Minimum Ply Rating	Rear Minimum Inflation (psi)	Manufacturer	Model	Bucket (cu. yd.)	Front Minimum Ply Rating	Front Minimum Inflation (psi)	Rear Minimum Ply Rating	Rear Minimum Inflation (psi)
Caterpillar	966E	5	1*	70	1*	60	Deere	744H-MH	5.75	1*	80	1*	60
Caterpillar	966F	5	1*	70	1*	60	Deere	744J	5.25	1*	75	1*	60
Caterpillar	966F-II	5	1*	70	1*	60	Deere	744J HL	5.25	1*	80	1*	60
Caterpillar	966G	4.75	1*	70	1*	60	Deere	744K	5.25	1*	75	1*	60
Caterpillar	966H	5.5	1*	75	1*	60	Deere	744K-HL	5.25	1*	80	1*	60
Caterpillar	966H	5.75	1*	75	1*	60	Deere	744K-II	5.25	1*	75	1*	60
Caterpillar	966K	5.5	1*	80	1*	60	Deere	744K-II HL	5.25	1*	80	1*	60
Caterpillar	966L	5.5	1*	75	1*	60	Deere	744L	5.25	1*	75	1*	60
Caterpillar	966M	5.5	1*	75	1*	60	Deere	744L HL	5.25	1*	80	1*	60
Caterpillar	966M XE	5.5	1*	75	1*	60	Deere	824J	6	1*	85	1*	60
Caterpillar	970F	5.25	1*	75	1*	60	Deere	824J HL	5.25	1*	80	1*	60
Caterpillar	972G	5.4	1*	75	1*	60	Deere	824K	6	1*	85	1*	60
Caterpillar	972H	5.5	1*	75	1*	60	Deere	824K-HL	6	1*	85	1*	60
Caterpillar	972K	5.5	1*	80	1*	60	Deere	824K-II	6	1*	85	1*	60
Caterpillar	972L	5.5	1*	80	1*	60	Deere	824K-II HL	6	1*	90	1*	60
Caterpillar	972M	6.3	1*	85	1*	60	Deere	824L	6	1*	85	1*	60
Caterpillar	972M XE	6	1*	80	1*	60	Deere	824L HL	6	2*	CT	1*	60
Case	921	4.75	1*	65	1*	60	Deere	844	6	1*	80	1*	60
Case	921B	4.75	1*	65	1*	60	Doosan	DL400	5.1	1*	70	1*	60
Case	921C	4.75	1*	65	1*	60	Doosan	DL420-5	5.5	1*	75	1*	60
Case	921E	5.75	1*	75	1*	60	Doosan	DL420-5 HL	5.5	1*	80	1*	60
Case	921E XR	5.75	1*	80	1*	60	Doosan	DL450	6.3	1*	85	1*	60
Case	921F	4.75	1*	65	1*	60	Doosan	DL450-3	5.88	1*	80	1*	60
Case	921F XR	4.75	1*	65	1*	60	Doosan	DL450-5	6.3	1*	85	1*	60
Case	1021G Z-Bar	4.75	1*	70	1*	60	Doosan	DL450-5 HL	6.3	1*	85	1*	60
Case	1021G Z-Bar	4.6	1*	70	1*	60	Fiattallis	FR220	5.1	1*	70	1*	60
Case	1021G Z-Bar	5.5	1*	80	1*	60	Fiattallis	FR220-2	5	1*	70	1*	60
Case	1021G XR	4.75	1*	75	1*	60	Fiat Hitachi	W270	5.2	1*	70	1*	60
Case	1021G XR	4.6	1*	75	1*	60	Fiat Hitachi	FR220-2	5	1*	70	1*	60
Case	1021G XR	5.5	1*	85	1*	60	Furukawa	FL330-I	4.3	1*	60	1*	60
Case	1121F Z-bar	5.25	1*	75	1*	60	Hitachi	ZW250-6	4.8	1*	65	1*	60
Case	1121F Z-bar	6.25	1*	85	1*	60	Hitachi	ZW250-6 HL	4.8	1*	70	1*	60
Case	1121F XR	5.25	1*	80	1*	60	Hitachi	ZW310	5.25	1*	70	1*	60
Case	1121F XR	6.25	2*	CT	1*	60	Hitachi	ZW310 HL	4.75	1*	70	1*	60
Case	1121G Z-Bar	5.25	1*	80	1*	60	Hitachi	ZW310-5	5.9	1*	80	1*	60
Case	1121G Z-Bar	5.1	1*	80	1*	60	Hitachi	ZW310-5 HL	5.25	1*	80	1*	60
Case	1121G Z-Bar	6.25	1*	90	1*	60	Hitachi	ZW310-6	5.5	1*	75	1*	60
Case	1121G XR	5.25	1*	85	1*	60	Hitachi	ZW310-6 HL	5.5	1*	80	1*	60
Case	1121G XR	5.1	1*	80	1*	60	Hitachi	ZW330-5	6.5	1*	90	1*	60
Case	1121G XR	6.25	2*	CT	1*	60	Hitachi	ZW330-5 HL	6	1*	90	1*	60
Daewoo	Mega 400	5.1	1*	70	1*	60	Hyundai	HL770	5	1*	75	1*	60
Daewoo	Mega 400-III	3.9	1*	65	1*	60	Hyundai	HL770-7	5.2	1*	70	1*	60
Deere	744E	5	1*	70	1*	60	Hyundai	HL770XTD-7	5.2	1*	75	1*	60
Deere	744H	5.25	1*	70	1*	60	Hyundai	HL770-7A	5.2	1*	70	1*	60
Deere	744H-HL	4.5	1*	70	1*	60	Hyundai	HL770XTD-7A	5.2	1*	75	1*	60

CONTINUES ON NEXT PAGE

26.5R25 LOADER USAGE CHART CONTINUED

For Standard Loader Service: <250 ft, < 5 mph



Manufacturer	Model	Bucket (cu. yd.)	Front Minimum Ply Rating	Front Minimum Inflation (psi)	Rear Minimum Ply Rating	Rear Minimum Inflation (psi)
Hyundai	HL770-9	5.5	1*	75	1*	60
Hyundai	HL770XTD-9	5.5	1*	80	1*	60
Hyundai	HL770-9A	5.5	1*	75	1*	60
Hyundai	HL770XTD-9A	5.5	1*	80	1*	60
Hyundai	HL780-7A	6.7	2*	CT	1*	60
Hyundai	HL780XTD-7A	6.7	2*	CT	1*	60
Hyundai	HL780-9	7.1	2*	CT	1*	60
Hyundai	HL780XTD-9	7.1	2*	CT	1*	65
Hyundai	HL780-9A	7.1	2*	CT	1*	60
Hyundai	HL780XTD-9A	7.1	2*	CT	1*	65
Hyundai	HL970	4.7	1*	70	1*	60
Hyundai	HL970 XTD	4.7	1*	70	1*	60
Hyundai	HL980	6.3	2*	CT	1*	60
Hyundai	HL980 XTD	6.3	2*	CT	1*	60
Kawasaki	85Z	4.2	1*	60	1*	60
Kawasaki	85ZII	4.2	1*	60	1*	60
Kawasaki	85ZIII	4.3	1*	65	1*	60
Kawasaki	85ZIV	4.3	1*	60	1*	60
Kawasaki	85ZIV-2	4.75	1*	65	1*	60
Kawasaki	85ZV-2	4.8	1*	65	1*	60
Kawasaki	85Z7	4.8	1*	65	1*	60
Kawasaki	85Z7 HL	4.8	1*	70	1*	60
Kawasaki	90ZIII	5	1*	70	1*	60
Kawasaki	90ZIV	5	1*	70	1*	60
Kawasaki	90ZIV-2	5.5	1*	75	1*	60
Kawasaki	90ZV	5.2	1*	75	1*	60
Kawasaki	90ZV	4.25	1*	65	1*	60
Kawasaki	90ZV-2	5.2	1*	70	1*	60
Kawasaki	90Z7	5.5	1*	75	1*	60
Kawasaki	90Z7 HL	5.5	1*	80	1*	60
Kawasaki	90Z7B	5.5	1*	75	1*	60
Kawasaki	90Z7B HL	5.5	1*	80	1*	60
Kawasaki	92ZV-2	6	1*	85	1*	60
Kawasaki	92Z7	6.3	1*	85	1*	60
Kawasaki	92Z7 HL	6.3	2*	CT	1*	60
Kawasaki	95ZV-2	7	2*	CT	1*	65
Komatsu	WA420-1	4.75	1*	65	1*	60
Komatsu	WA420-3	6	1*	70	1*	60
Komatsu	WA430-6	4.6	1*	60	1*	60
Komatsu	WA450-2	5.5	1*	75	1*	60
Komatsu	WA450-3	6.8	1*	85	1*	60
Komatsu	WA470-6	5.5	1*	75	1*	60
Komatsu	WA470-7	5.5	1*	75	1*	60
Komatsu	WA470-8	5	1*	75	1*	60
Komatsu	WA470-8 HL	5	1*	75	1*	60
Komatsu	WA480-6	6	1*	80	1*	60

Manufacturer	Model	Bucket (cu. yd.)	Front Minimum Ply Rating	Front Minimum Inflation (psi)	Rear Minimum Ply Rating	Rear Minimum Inflation (psi)
Komatsu	WA480-8	6	1*	85	1*	60
Komatsu Dresser	542	4.75	1*	65	1*	60
Komatsu Dresser	545	5.5	1*	80	1*	60
Komatsu Dresser	550	5.25	1*	75	1*	60
Liebherr	L566	5.2	1*	70	1*	60
Liebherr	L566 HL	4.6	1*	70	1*	60
Liebherr	L566 XP	5.5	1*	80	1*	60
Liebherr	L576	6.15	1*	85	1*	60
Liebherr	L576 HL	5.5	1*	80	1*	60
Liebherr	L580	6.5	1*	85	1*	60
Liebherr	L580 HL	5.9	1*	80	1*	60
Liebherr	L580 XP	6.8	2*	CT	1*	60
Terex	80C	5.5	1*	80	1*	60
Volvo	L150C	5.2	1*	70	1*	60
Volvo	L150D	5.2	1*	75	1*	60
Volvo	L150F	5.8	1*	80	1*	60
Volvo	L150G	6.8	1*	90	1*	60
Volvo	L150H	5.25	1*	75	1*	60
Volvo	L180	5.5	1*	75	1*	60
Volvo	L180C	6	1*	80	1*	60
Volvo	L180D	6.3	1*	85	1*	60
Volvo	L180F	6.3	1*	85	1*	60
Volvo	L180G	7.6	2*	CT	1*	60
Volvo	L180H	5.75	1*	85	1*	60
Volvo	L190	5.2	1*	80	1*	60
Volvo	L190B	5.2	1*	80	1*	60

For service under chains, or load and carry operations, contact Titan Technical Services.

Pressure and ply recommendations based on normal quarry operations with standard equipment. For different applications, or modified equipment, please contact OTR Field Engineering for a specific recommendation. Tire damage or failure caused by improper load, ply, speed or inflation practices is not covered by the Titan Tire Warranty Policy.

CT - Contact Titan Technical services
HL - High Lift, extended booms, etc.

29.5R25 LOADER USAGE CHART

For Standard Loader Service: <250 ft, < 5 mph



Manufacturer	Model	Bucket (cu. yd.)	Front Minimum Ply Rating	Front Minimum Inflation (psi)	Rear Minimum Ply Rating	Rear Minimum Inflation (psi)
Caterpillar	980C	6.75	1*	80	1*	60
Caterpillar	980F	7	1*	80	1*	60
Caterpillar	980F-II	7	1*	80	1*	60
Caterpillar	980G	7	1*	85	1*	60
Caterpillar	980H	7.5	1*	85	1*	60
Caterpillar	980K	7.5	1*	85	1*	60
Caterpillar	980M	7.5	1*	80	1*	60
Case	1221E	9.2	1*	60	1*	60
Case	1221E XR	9.2	1*	60	1*	60
Deere	744J	5.25	1*	60	1*	60
Deere	744J HL	5.25	1*	65	1*	60
Deere	824J	6	1*	70	1*	60
Deere	824J HL	5.25	1*	70	1*	60
Deere	824K	6	1*	70	1*	60
Deere	824K HL	6	1*	75	1*	60
Deere	824K-II	6	1*	70	1*	60
Deere	824K-II HL	6	1*	75	1*	60
Deere	844J	7.25	1*	85	1*	60
Deere	844K	7.25	1*	85	1*	60
Deere	844K-II	7.25	1*	85	1*	60
Deere	844K-III	7.25	1*	85	1*	60
Deere	844L	7.25	1*	85	1*	60
Doosan	DL500	6.8	1*	80	1*	60
Doosan	DL550-5	7.5	1*	85	1*	60
Doosan	DL550-5 HL	7.5	2*	CT	1*	60
Furukawa	FL460	6	1*	75	1*	60
Hitachi	ZW370-5	8.1	2*	CT	1*	60
Hitachi	ZW370-5 HL	7.3	2*	CT	1*	60
Hitachi	ZW370-6	7.3	1*	85	1*	60
Hitachi	ZW370-6 HL	7.3	2*	CT	1*	60
Hyundai	HL780-7A	6.7	1*	75	1*	60
Hyundai	HL780XTD-7A	6.7	1*	80	1*	60
Hyundai	HL780-9	7.1	1*	80	1*	60
Hyundai	HL780XTD-9	7.1	1*	85	1*	60
Hyundai	HL780-9A	7.1	1*	80	1*	60
Hyundai	HL780XTD-9A	7.1	1*	85	1*	60
Hyundai	HL980	6.3	1*	75	1*	60
Hyundai	HL980 XTD	6.3	1*	80	1*	60
Kawasaki	95Z	6	1*	70	1*	60
Kawasaki	95ZII	6	1*	70	1*	60
Kawasaki	95ZIII	6.5	1*	80	1*	60
Kawasaki	95ZIV	6.5	1*	75	1*	60
Kawasaki	95ZIV-2	7.25	1*	80	1*	60
Kawasaki	95ZIV-3	7.25	1*	80	1*	60
Kawasaki	95ZV-2	7	1*	80	1*	60
Kawasaki	95Z7	7.3	1*	90	1*	60
Kawasaki	95Z7 HL	7.3	1*	90	1*	60
Komatsu	WA500-1	6	1*	75	1*	60
Komatsu	WA500-3	7.2	1*	80	1*	60
Komatsu	WA500-6	7.3	1*	85	1*	60
Komatsu	WA500-7	7.3	1*	85	1*	60
Komatsu	WA500-7 HL	5.9	1*	80	1*	60
Komatsu	WA500-7 SM	5.25	1*	80	1*	60
Komatsu	WA500-8	7.6	1*	90	1*	60
Komatsu	WA500-8 HL	5.9	1*	80	1*	60
Komatsu Dresser	555	6	1*	80	1*	60
Komatsu Dresser	558	6	1*	75	1*	60
Liebherr	L586	7.85	1*	90	1*	60
Liebherr	L586 HL	7.2	1*	85	1*	60
Liebherr	L586XP	7.8	2*	CT	1*	60
Volvo	L190	5.2	1*	65	1*	60
Volvo	L190B	5.2	1*	65	1*	60
Volvo	L220D	7	1*	75	1*	60
Volvo	L220E	7.1	1*	85	1*	60
Volvo	L220F	6.3	1*	80	1*	60
Volvo	L220F	7.8	1*	90	1*	60
Volvo	L220G	8.2	2*	CT	1*	60
Volvo	L220H	6.8	1*	80	1*	60
Volvo	L260H	8.4	2*	CT	1*	60
Volvo	L260H HL	7.2	1*	85	1*	60

For service under chains, or load and carry operations, contact Titan Technical Services.

Pressure and ply recommendations based on normal quarry operations with standard equipment. For different applications, or modified equipment, please contact OTR Field Engineering for a specific recommendation. Tire damage or failure caused by improper load, ply, speed or inflation practices is not covered by the Titan Tire Warranty Policy.

CT - Contact Titan Technical services
HL - High Lift, extended booms, etc.

750/65R25 LOADER USAGE CHART

For Standard Loader Service: <250 ft, < 5 mph



Manufacturer	Model	Bucket (cu. yd.)	Front Minimum Ply Rating	Front Minimum Inflation (psi)	Rear Minimum Ply Rating	Rear Minimum Inflation (psi)
Caterpillar	950K	4	1*	60	1*	60
Caterpillar	950M	4.5	1*	65	1*	60
Caterpillar	962K	4.5	1*	65	1*	60
Caterpillar	962M	4.7	1*	65	1*	60
Caterpillar	966H	4.75	1*	65	1*	60
Caterpillar	972H	5.5	1*	75	1*	60
Deere	644K	4.25	1*	60	1*	60
Deere	644K-HL	4.25	1*	60	1*	60
Deere	724J	4.75	1*	60	1*	60
Deere	724J-HL	4.25	1*	60	1*	60
Deere	724K	4.75	1*	60	1*	60
Deere	724K-HL	4.75	1*	65	1*	60
Hitachi	ZW250-6	4.8	1*	65	1*	60
Hitachi	ZW250-6 HL	4.8	1*	65	1*	60
Hitachi	ZW310-6	5.5	1*	70	1*	60
Hitachi	ZW310-6 HL	5.5	1*	75	1*	60
Kawasaki	85Z7	4.8	1*	65	1*	60
Kawasaki	85Z7 HL	4.8	1*	65	1*	60
Kawasaki	90Z7	5.5	1*	75	1*	60
Kawasaki	90Z7 HL	5.5	1*	80	1*	60
Kawasaki	90Z7B	5.5	1*	70	1*	60
Kawasaki	90Z7B HL	5.5	1*	75	1*	60
Kawasaki	92Z7	6.3	1*	85	1*	60
Kawasaki	92Z7 HL	6.3	2*	CT	1*	60
Liebherr	L550	4.2	1*	60	1*	60
Liebherr	L550 HL	3.4	1*	60	1*	60
Liebherr	L550XP	4.2	1*	60	1*	60
Liebherr	L550XP HL	3.4	1*	60	1*	60
Liebherr	L556	4.7	1*	60	1*	60
Liebherr	L556 HL	3.7	1*	60	1*	60
Liebherr	L556XP	4.7	1*	60	1*	60
Liebherr	L556XP HL	3.7	1*	60	1*	60
Volvo	L110H	4	1*	60	1*	60
Volvo	L120H	4.25	1*	60	1*	60

875/65R29 LOADER USAGE CHART

For Standard Loader Service: <250 ft, < 5 mph



Manufacturer	Model	Bucket (cu. yd.)	Front Minimum Ply Rating	Front Minimum Inflation (psi)	Rear Minimum Ply Rating	Rear Minimum Inflation (psi)
Caterpillar	982M	8	1*	75	1*	60
Deere	844K-II	7.25	1*	70	1*	60
Deere	844K-III	7.25	1*	70	1*	60
Deere	844L	7.25	1*	70	1*	60
Kawasaki	95Z7 Xtreme	7.7	1*	75	1*	60
Volvo	L220H	6.8	1*	65	1*	60
Volvo	L260H	8.4	1*	75	1*	60
Volvo	L260H HL	7.2	1*	75	1*	60

For service under chains, or load and carry operations, contact Titan Technical Services.

Pressure and ply recommendations based on normal quarry operations with standard equipment. For different applications, or modified equipment, please contact OTR Field Engineering for a specific recommendation. Tire damage or failure caused by improper load, ply, speed or inflation practices is not covered by the Titan Tire Warranty Policy.

CT - Contact Titan Technical services
HL - High Lift, extended booms, etc.

35/65R33 LOADER USAGE CHART

For Standard Loader Service: <250 ft, < 5 mph



PIT LOADER APPLICATION						
Manufacturer	Model	Bucket (cu. yd.)	Front Minimum Ply Rating	Front Minimum Inflation (psi)	Rear Minimum Ply Rating	Rear Minimum Inflation (psi)
Caterpillar	986H	6.12	1*	80	1*	65
Caterpillar	986H HL	5.35	1*	80	1*	65
Caterpillar	986K	6.8	1*	85	1*	65
Caterpillar	986K HL	5.8	1*	85	1*	65
Caterpillar	988B	8.25	2*	100	1*	65
Caterpillar	988F	7.75	2*	100	1*	65
Caterpillar	988G	8	2*	110	1*	70
Caterpillar	988H	8.2	2*	110	1*	70
Caterpillar	988H	8.33	2*	110	1*	70
Caterpillar	988H	9.2	CT	CT	2*	75
Caterpillar	988H HL	8.33	2*	110	1*	70
Caterpillar	988K	8.4	2*	110	1*	70
Caterpillar	988K HL	8.4	CT	CT	1*	75
Caterpillar	988K Steel Mill	5.5	1*	80	1*	65
Caterpillar	988K Steel Mill	6.5	1*	80	1*	65
Caterpillar	988K XE	9.2	CT	CT	2*	80
Deere	944K	10	CT	CT	2*	80
Deere	944K HL	10	CT	CT	2*	80
Hitachi	ZW550-5	8.9	2*	105	1*	65
Hitachi	ZW550-5 HL	7.3	2*	100	1*	65
Hitachi	ZW550-6	8.2	2*	100	1*	65
Hitachi	ZW550-6 HL	9	2*	110	1*	70
Kawasaki	110Z	7.5	2*	90	1*	65
Kawasaki	110ZII	7.5	2*	90	1*	65
Kawasaki	115ZIII	7.5	2*	90	1*	65
Kawasaki	115ZIV	7.5	2*	95	1*	65
Kawasaki	115ZIV-2	8.25	2*	105	1*	65
Kawasaki	115ZV	7.5	2*	95	1*	65
Kawasaki	115ZV-2	8.3	2*	100	1*	65
Kawasaki	115ZV-2 HL	6.5	1*	90	1*	65
Kawasaki	115Z7	8.3	2*	100	1*	65
Kawasaki	115Z7 HL	9	2*	110	1*	70
Kawasaki	115Z7 Xtreme	9.15	2*	105	1*	70
Komatsu	WA600-1	7.1	1*	85	1*	65
Komatsu	WA600-3	8	2*	95	1*	65
Komatsu	WA600-6	8.4	2*	110	1*	70
Komatsu	WA600-6	9.5	CT	CT	2*	75
Komatsu	WA600-8	8.4	2*	110	1*	70
Komatsu Dresser	568	7.5	2*	90	1*	65
O&K	7500	7	1*	90	1*	65
Sandvik	LH621-10	10.5	CT	CT	1*	75
Terex	90C	8.5	2*	100	1*	65
Volvo	L320	8	2*	100	1*	65

YARD LOADER APPLICATION						
Manufacturer	Model	Bucket (cu. yd.)	Front Minimum Ply Rating	Front Minimum Inflation (psi)	Rear Minimum Ply Rating	Rear Minimum Inflation (psi)
Caterpillar	986H	6.12	1*	70	1*	65
Caterpillar	986H HL	5.35	1*	70	1*	65
Caterpillar	986K	6.8	1*	75	1*	65
Caterpillar	986K HL	5.8	1*	75	1*	65
Caterpillar	988B	8.25	1*	90	1*	65
Caterpillar	988F	7.75	1*	85	1*	65
Caterpillar	988G	8	2*	95	1*	65
Caterpillar	988H	8.2	2*	95	1*	65
Caterpillar	988H	8.33	2*	95	1*	65
Caterpillar	988H	9.2	2*	100	1*	65
Caterpillar	988H HL	8.33	2*	95	1*	65
Caterpillar	988K	8.4	2*	95	1*	65
Caterpillar	988K HL	8.4	2*	100	1*	65
Caterpillar	988K Steel Mill	5.5	1*	80	1*	65
Caterpillar	988K Steel Mill	6.5	1*	80	1*	65
Caterpillar	988K XE	9.2	2*	105	1*	65
Deere	944K	10	2*	100	1*	65
Deere	944K HL	10	2*	105	1*	70
Hitachi	ZW550-5	8.9	1*	90	1*	65
Hitachi	ZW550-5 HL	7.3	1*	85	1*	65
Hitachi	ZW550-6	8.2	1*	85	1*	65
Hitachi	ZW550-6 HL	9	2*	95	1*	65
Kawasaki	110Z	7.5	1*	80	1*	65
Kawasaki	110ZII	7.5	1*	80	1*	65
Kawasaki	115ZIII	7.5	1*	80	1*	65
Kawasaki	115ZIV	7.5	1*	85	1*	65
Kawasaki	115ZIV-2	8.25	1*	90	1*	65
Kawasaki	115ZV	7.5	1*	85	1*	65
Kawasaki	115ZV-2	8.3	1*	90	1*	65
Kawasaki	115ZV-2 HL	6.5	1*	80	1*	65
Kawasaki	115Z7	8.3	1*	85	1*	65
Kawasaki	115Z7 HL	9	2*	95	1*	65
Kawasaki	115Z7 Xtreme	9.15	1*	90	1*	65
Komatsu	WA600-1	7.1	1*	75	1*	65
Komatsu	WA600-3	8	1*	80	1*	65
Komatsu	WA600-6	8.4	2*	95	1*	65
Komatsu	WA600-6	9.5	2*	100	1*	65
Komatsu	WA600-8	8.4	2*	95	1*	65
Komatsu Dresser	568	7.5	1*	80	1*	65
O&K	7500	7	1*	80	1*	65
Sandvik	LH621-10	10.5	CT	CT	1*	75
Terex	90C	8.5	1*	85	1*	65
Volvo	L320	8	1*	85	1*	65

CONTINUES ON NEXT PAGE

35/65R33 LOADER USAGE CHART CONTINUED

For Standard Loader Service: <250 ft, < 5 mph



PIT LOADER APPLICATION						
Manufacturer	Model	Bucket (cu. yd.)	Front Minimum Ply Rating	Front Minimum Inflation (psi)	Rear Minimum Ply Rating	Rear Minimum Inflation (psi)
Volvo	L330C	8.6	2*	105	1*	70
Volvo	L330D	8.6	2*	105	1*	70
Volvo	L330E	8.6	2*	105	1*	70
Volvo	L350F	10.1	CT	CT	2*	80
Volvo	L350H	9.5	2*	110	1*	70
Volvo	L350H HL	9.5	CT	CT	1*	75

YARD LOADER APPLICATION						
Manufacturer	Model	Bucket (cu. yd.)	Front Minimum Ply Rating	Front Minimum Inflation (psi)	Rear Minimum Ply Rating	Rear Minimum Inflation (psi)
Volvo	L330C	8.6	2*	90	1*	65
Volvo	L330D	8.6	2*	90	1*	65
Volvo	L330E	8.6	2*	95	1*	65
Volvo	L350F	10.1	2*	100	1*	65
Volvo	L350H	9.5	2*	95	1*	65
Volvo	L350H HL	9.5	2*	100	1*	65

For service under chains, or load and carry operations, contact Titan Technical Services.

Pressure and ply recommendations based on normal quarry operations with standard equipment. For different applications, or modified equipment, please contact OTR Field Engineering for a specific recommendation. Tire damage or failure caused by improper load, ply, speed or inflation practices is not covered by the Titan Tire Warranty Policy.

CT - Contact Titan Technical services
HL - High Lift, extended booms, etc.

45/65R45 LOADER USAGE CHART

For Standard Loader Service: <250 ft, < 5 mph



Manufacturer	Model	Bucket (cu. yd.)	Front Minimum Ply Rating	Front Minimum Inflation (psi)	Rear Minimum Ply Rating	Rear Minimum Inflation (psi)
Caterpillar	992B	10	1*	75	1*	65
Caterpillar	992C	12.5	2*	100	1*	65
Caterpillar	992C HL	12.5	2*	105	1*	70
Caterpillar	992D	14	2*	105	1*	65
Caterpillar	992D HL	12	2*	100	1*	65
Caterpillar	992G	15	2*	110	1*	70
Caterpillar	992G HL	15	CT	CT	1*	75
Caterpillar	992K	14	2*	110	1*	70
Caterpillar	992K HL	14	2*	105	1*	65
Komatsu	WA800-2	13.7	2*	100	1*	65
Komatsu	WA800-3	14.4	2*	105	1*	70
Komatsu	WA900-3	17	CT	CT	2*	85
Komatsu	WA900-3 HL	15	CT	CT	2*	80
Komatsu	WA900-8	17	CT	CT	2*	85
Komatsu	WA900-8 HL	15	CT	CT	2*	80
LeTourneau	L-950-2	18	2*	105	1*	70
LeTourneau	L-950-2 HL	16	2*	105	1*	65
LeTourneau	L1000	17	CT	CT	2*	75

50/65R51 LOADER USAGE CHART

For Standard Loader Service: <250 ft, < 5 mph



Manufacturer	Model	Bucket (cu. yd.)	Front Minimum Ply Rating	Front Minimum Inflation (psi)	Rear Minimum Ply Rating	Rear Minimum Inflation (psi)
Caterpillar	993K	17	CT	CT	1*	75
Caterpillar	993K HL	17	CT	CT	2*	80
Caterpillar	993K HL	19	CT	CT	2*	85
Letourneau	L-1100	22	CT	CT	1*	75
Letourneau	L-1100 HL	20	2*	110	1*	70
Letourneau (P&H)	L-1150-2	25	CT	CT	2*	80
Letourneau (P&H)	L-1150-2 HL	23	CT	CT	2*	80

For service under chains, or load and carry operations, contact Titan Technical Services.

Pressure and ply recommendations based on normal quarry operations with standard equipment. For different applications, or modified equipment, please contact OTR Field Engineering for a specific recommendation. Tire damage or failure caused by improper load, ply, speed or inflation practices is not covered by the Titan Tire Warranty Policy.

CT - Contact Titan Technical services
HL - High Lift, extended booms, etc.

58/80R63 LOADER USAGE CHART

For Standard Loader Service: <250 ft, < 5 mph



Manufacturer	Model	Bucket (cu. yd.)	Front Minimum Ply Rating	Front Minimum Inflation (psi)	Rear Minimum Ply Rating	Rear Minimum Inflation (psi)
Caterpillar	994F STD (Tier 1)	25	2*	110	2*	80
Caterpillar	994F HL (Tier 1)	22.5	2*	110	2*	80
Caterpillar	994F EHL (Tier 1)	22.5	2*	115	2*	80
Caterpillar	994F SHL (Tier 1)	22.5	2*	115	2*	80
Caterpillar	994H STD	25	2*	105	2*	80
Caterpillar	994H HL	22.5	2*	110	2*	80
Caterpillar	994H EHL	22.5	2*	115	2*	80
Caterpillar	994H SHL	22.5	2*	120	2*	80
Caterpillar	994K	25	2*	120	2*	80
Caterpillar	994K HL	22.5	2*	120	2*	80
Komatsu	WA1200-3	26.2	2*	110	2*	80
Komatsu	WA1200-3 HL	23.5	2*	110	2*	80
Komatsu	WA1200-6 Rock	26.2	2*	115	2*	80
Komatsu	WA1200-6 Coal	45.8	2*	115	2*	80
Komatsu	WA1200-6 HL Rock	23.5	2*	115	2*	80
Komatsu	WA1200-6 HL Coal	45.8	2*	115	2*	80
Letourneau (P&H)	L-1850 STD	40	2*	120	2*	80
Letourneau (P&H)	L-1850 HL	30	2*	120	2*	80

For service under chains, or load and carry operations, contact Titan Technical Services.

Pressure and ply recommendations based on normal quarry operations with standard equipment. For different applications, or modified equipment, please contact OTR Field Engineering for a specific recommendation. Tire damage or failure caused by improper load, ply, speed or inflation practices is not covered by the Titan Tire Warranty Policy.

CT - Contact Titan Technical services

HL - High Lift, extended booms, etc.

RADIAL RIGID DUMP TRUCK

18.00R33 RIGID DUMP TRUCK USAGE CHART

For Standard Earthmover Service: <2.5 mile, < 30 mph



Manufacturer	Model	Bucket (cu. yd.)	Front Minimum Ply Rating	Front Minimum Inflation (psi)	Rear Minimum Ply Rating	Rear Minimum Inflation (psi)
Astra	RD 40C	44	2*	115	2*	115
Caterpillar	769B	35	2*	95	2*	90
Caterpillar	769C	40	2*	110	2*	110
Caterpillar	769D	35	2*	110	2*	110
Caterpillar	770	40	CT	CT	2*	115
Caterpillar	770F	49	2*	115	2*	115
Caterpillar	770G	50	2*	115	2*	CT
Caterpillar	771C Quarry	44	CT	CT	CT	CT
Caterpillar	771D	45	CT	CT	CT	CT
Euclid	R35	35	2*	105	2*	105
Euclid	R36	40	2*	95	2*	100
Euclid	R40	42	2*	110	2*	110
Euclid	R40C	42	2*	115	2*	115
Hitachi	EH650	40	2*	95	2*	100
Hitachi	EH700	42	2*	115	2*	115
Hitachi	EH750	43	CT	CT	CT	CT
Hitachi	EH750-3	46	CT	CT	CT	CT
Komatsu	HD325-3	35	2*	85	2*	95
Komatsu	HD325-5	35	2*	85	2*	95
Komatsu	HD325-6 Quarry	44	2*	115	CT	CT
Komatsu	HD325-6 4WD	35	2*	100	2*	100
Komatsu	HD325-6	44	2*	105	2*	115
Komatsu	HD325-7	40	2*	110	2*	115
Komatsu	HD325-8	40	2*	CT	2*	115
Komatsu	HD405-7	45	CT	CT	CT	CT
Komatsu Haulpak	140M	40	2*	110	2*	110
Perlini	DP 405 WD	44	2*	115	2*	115
Terex	3340	40	CT	CT	2*	115

Pressure and ply recommendations based on normal quarry operations with standard equipment. For different applications, or modified equipment, please contact OTR Field Engineering for a specific recommendation. Tire damage or failure caused by improper load, ply, speed or inflation practices is not covered by the Titan Tire Warranty Policy.

CT - Contact Titan Technical services

24.00R35 RIGID DUMP TRUCK USAGE CHART

For Standard Earthmover Service: <2.5 mile, < 30 mph



Manufacturer	Model	Bucket (cu. yd.)	Front Minimum Ply Rating	Front Minimum Inflation (psi)	Rear Minimum Ply Rating	Rear Minimum Inflation (psi)
Caterpillar	773	50	2*	75	2*	70
Caterpillar	773B	58	2*	85	2*	85
Caterpillar	773D	50	2*	85	2*	85
Caterpillar	773E	60	2*	90	2*	90
Caterpillar	773F	60	2*	100	2*	90
Caterpillar	773G	54	2*	85	2*	85
Caterpillar	773G-4T	69	2*	105	2*	95
Caterpillar	775B Quarry	65	2*	95	2*	95
Caterpillar	775D	65	2*	95	2*	105
Caterpillar	775E	70	2*	95	2*	110
Caterpillar	775F	70	2*	105	2*	105
Caterpillar	775G	70	2*	110	2*	105
Caterpillar	775G-4T	79	2*	110	2*	105
Dart	2085	85	1*	65	2*	75
Hitachi	EH1000	66	2*	95	2*	95
Hitachi	EH1100	72	2*	100	2*	105
Hitachi	EH1100-3	72	2*	100	2*	110
Hitachi	EH1100-5	70	2*	105	2*	105
Euclid	R50	58	2*	80	2*	80
Euclid	R60	63	2*	85	2*	90
Euclid	R60C	66	2*	105	2*	90
Euclid	R65	69	2*	95	2*	95
Euclid	R65C	71	2*	100	2*	105
Euclid	R75	75	2*	110	2*	105
Komatsu	HD465-3	51	2*	70	2*	75
Komatsu	HD465-5	61	2*	75	2*	80
Komatsu	HD465-5 Quarry	66	2*	95	2*	105
Komatsu	HD465-7	61	2*	90	2*	95
Komatsu	HD465-8	61	2*	115	2*	110
Komatsu	HD605-7	70	2*	100	2*	110
Komatsu	HD605-8	69	2*	110	2*	110
Komatsu-Haulpak	210M	60	2*	85	2*	85
Perlini	DP705 WD	72	2*	105	2*	105
Terex	3308E	55	2*	80	2*	80
Terex	3309	55	2*	90	2*	90
Terex	3310E	66	2*	100	2*	100
Terex	TR60	60	2*	90	2*	85
Terex	TR70	72	2*	110	2*	105

Pressure and ply recommendations based on normal quarry operations with standard equipment. For different applications, or modified equipment, please contact OTR Field Engineering for a specific recommendation. Tire damage or failure caused by improper load, ply, speed or inflation practices is not covered by the Titan Tire Warranty Policy.

CT - Contact Titan Technical services

27.00R49 RIGID DUMP TRUCK USAGE CHART

For Standard Earthmover Service: <2.5 mile, < 30 mph



Manufacturer	Model	Bucket (cu. yd.)	Front Minimum Ply Rating	Front Minimum Inflation (psi)	Rear Minimum Ply Rating	Rear Minimum Inflation (psi)
Caterpillar	777	85	2*	80	2*	85
Caterpillar	777B	95	2*	90	2*	95
Caterpillar	777C	95	2*	95	2*	95
Caterpillar	777D	100	2*	105	2*	105
Caterpillar	777E	108	2*	95	2*	115
Caterpillar	777F	100	2*	105	2*	105
Caterpillar	777G	100	2*	110	2*	110
Dart	3100B	100	2*	105	2*	110
Euclid	R85B	85	2*	90	2*	95
Euclid	R90	96	2*	95	2*	95
Euclid	R90C	100	2*	100	2*	100
Euclid	R100	100	2*	100	2*	105
Hitachi	EH1600	99	2*	105	2*	105
Hitachi	EH1700	108	2*	110	2*	115
Hitachi	EH1700-3	100	2*	105	2*	105
Komatsu	HD785-1	86	2*	80	2*	85
Komatsu	HD785-3	86	2*	85	2*	90
Komatsu	HD785-3	100	2*	90	2*	100
Komatsu	HD785-5	106	2*	110	2*	110
Komatsu	HD785-7	100	2*	100	2*	110
Komatsu	HD785-8	100	2*	110	2*	110
Komatsu Haulpak	325M	95	2*	95	2*	95
Komatsu Haulpak	330M	100	2*	100	2*	105
Kress	CH160	160	2*	105	2*	105
Kress	CH180	180	2*	CT	2*	CT
Liebherr	T236	110	CT	CT	2*	CT
Perlini	DP905	105	2*	100	2*	105
Rimpull	RD100	100	2*	95	2*	100
Rimpull	RD100C	100	2*	95	2*	105
Terex	3311C	85	2*	80	2*	80
Terex	3311D	77	2*	95	2*	80
Terex	3311E	94	2*	100	2*	90
Terex	TR100	100	2*	105	2*	100
Terex	TR100 (HR)	94	2*	105	2*	100
Terex	TR100 DD	100	2*	105	2*	100
Unit Rig	Dart 3100	100	2*	100	2*	105
Unit Rig	Dart 4160	160	1*	65	2*	95
Unit Rig	M85	85	2*	80	2*	80
Unit Rig	M100	100	2*	95	2*	95
Unit Rig	M120-15	120	2*	115	2*	115
Unit Rig	Mark 24	85	2*	95	2*	80

Pressure and ply recommendations based on normal quarry operations with standard equipment. For different applications, or modified equipment, please contact OTR Field Engineering for a specific recommendation. Tire damage or failure caused by improper load, ply, speed or inflation practices is not covered by the Titan Tire Warranty Policy.

CT - Contact Titan Technical services

33.00R51 RIGID DUMP TRUCK USAGE CHART

For Standard Earthmover Service: <2.5 mile, < 30 mph



Manufacturer	Model	Bucket (cu. yd.)	Front Minimum Ply Rating	Front Minimum Inflation (psi)	Rear Minimum Ply Rating	Rear Minimum Inflation (psi)
Belaz	75131	150	2*	110	2*	110
Belaz	75137NA	150	2*	110	2*	110
Caterpillar	785	155	2*	105	2*	105
Caterpillar	785B	155	2*	105	2*	105
Caterpillar	785C	150	2*	110	2*	115
Caterpillar	785D	157	2*	115	2*	115
Caterpillar	785G	157	2*	110	2*	115
Euclid	R120E	120	2*	75	2*	80
Euclid	R130	152	2*	95	2*	95
Euclid	R130B	146	2*	100	2*	100
Euclid	R130M	130	2*	80	2*	85
Euclid	R150	150	2*	105	2*	105
Komatsu Haulpak	510E	150	2*	105	2*	105
Komatsu Haulpak	530M	165	2*	110	2*	115
Komatsu	HD1500-7	159	2*	110	2*	115
Terex	MT3300	150	2*	110	2*	110
Terex	MT3300AC	150	2*	115	2*	115
Terex	MT3314B	125	2*	85	2*	85

37.00R57 RIGID DUMP TRUCK USAGE CHART

For Standard Earthmover Service: <2.5 mile, < 30 mph



Manufacturer	Model	Bucket (cu. yd.)	Front Minimum Ply Rating	Front Minimum Inflation (psi)	Rear Minimum Ply Rating	Rear Minimum Inflation (psi)
CAT	789C	195	2*	105	2*	110
CAT	789D	200	2*	110	2*	110
Euclid	R190	190	2*	90	2*	95
Hitachi	EH3500AC11	185	2*	95	2*	110
Hitachi	EH3500AC-3	200	2*	105	2*	110
Komatsu	730E	203	2*	110	2*	110
Komatsu	730E-8	200	2*	115	2*	110
Terex	MT 3700	205	2*	110	CT	CT

Pressure and ply recommendations based on normal quarry operations with standard equipment. For different applications, or modified equipment, please contact OTR Field Engineering for a specific recommendation. Tire damage or failure caused by improper load, ply, speed or inflation practices is not covered by the Titan Tire Warranty Policy.

CT - Contact Titan Technical services

40.00R57 RIGID DUMP TRUCK USAGE CHART

For Standard Earthmover Service: <2.5 mile, < 30 mph



Manufacturer	Model	Bucket (cu. yd.)	Front Minimum Ply Rating	Front Minimum Inflation (psi)	Rear Minimum Ply Rating	Rear Minimum Inflation (psi)
Belaz	75302NA	243	2*	110	2*	110
Belaz	75310	265	CT	CT	CT	CT
Caterpillar	789D	200	2*	90	2*	90
Caterpillar	793C	250	2*	110	2*	115
Caterpillar	793D	240	2*	110	2*	115
Caterpillar	793F	247	NR	NR	NR	NR
Caterpillar	793F SLWS	250	NR	NR	NR	NR
Caterpillar	793F XLWS	247	NR	NR	NR	NR
Hitachi	EH3500AC-II	185	2*	80	2*	90
Hitachi	EH3500AC-3	200	2*	90	2*	90
Hitachi	EH4000AC-II	250	2*	105	2*	105
Hitachi	EH4000AC-3	250	2*	105	2*	105
Komatsu	730E-8	200	2*	95	2*	90
Komatsu	830E	244	2*	110	2*	115
Komatsu	830E-AC	244	2*	110	2*	115
Liebherr	T264	244	2*	110	2*	115
Terex	MT 3700	205	2*	90	2*	95
Terex	MT 4400	260	2*	115	2*	115

46/90R57 RIGID DUMP TRUCK USAGE CHART

For Standard Earthmover Service: <2.5 mile, < 30 mph



Manufacturer	Model	Bucket (cu. yd.)	Front Minimum Ply Rating	Front Minimum Inflation (psi)	Rear Minimum Ply Rating	Rear Minimum Inflation (psi)
Belaz	75302NA	243	2*	100	2*	105
Belaz	75310	265	2*	110	2*	115
CAT	793F	250	2*	105	2*	105
Caterpillar	793F SLWS	250	2*	105	2*	110
Caterpillar	793F XLWS	247	2*	105	2*	110
Hitachi	EH4000AC-2	243	2*	105	2*	105
Hitachi	EH4000AC-3	250	2*	100	2*	100
Komatsu	830E-AC	244	2*	105	2*	110
Liebherr	T264	251	2*	110	2*	110
Terex	MT 3700	205	2*	85	2*	90
Terex	MT 4400	260	2*	110	2*	110
Terex	MT 4400AC	260	2*	110	2*	110

Pressure and ply recommendations based on normal quarry operations with standard equipment. For different applications, or modified equipment, please contact OTR Field Engineering for a specific recommendation. Tire damage or failure caused by improper load, ply, speed or inflation practices is not covered by the Titan Tire Warranty Policy.

CT - Contact Titan Technical services

50/80R57 RIGID DUMP TRUCK USAGE CHART

For Standard Earthmover Service: <2.5 mile, < 30 mph



Manufacturer	Model	Bucket (cu. yd.)	Front Minimum Ply Rating	Front Minimum Inflation (psi)	Rear Minimum Ply Rating	Rear Minimum Inflation (psi)
Bucyrus	MT4400 AC	240	2*	90	2*	90
Caterpillar	793F	250	2*	90	2*	90
Caterpillar	793F XLWS	247	2*	90	2*	90
Hitachi	EH4500-2	282	2*	105	2*	100
Komatsu	830E-5	250	2*	95	2*	95
Komatsu	860E-1K	280	2*	110	2*	110
Liebherr	T264	265	2*	95	2*	100
Liebherr	T272	320	2*	105	2*	105

53/80R63 RIGID DUMP TRUCK USAGE CHART

For Standard Earthmover Service: <2.5 mile, < 30 mph



Manufacturer	Model	Bucket (cu. yd.)	Front Minimum Ply Rating	Front Minimum Inflation (psi)	Rear Minimum Ply Rating	Rear Minimum Inflation (psi)
Caterpillar	MT5300AC	320	2*	110	2*	115
Caterpillar	794 AC	320	2*	110	2*	115
Hitachi	EH5000AC-II	320	2*	105	2*	105
Hitachi	EH5000AC-3	326	2*	105	2*	105
Komatsu	930E-2	320	2*	110	2*	105
Komatsu	930E-3	320	2*	105	2*	105
Komatsu	930E-4	320	2*	105	2*	105
Komatsu	930E-4SE	320	2*	105	2*	110
Komatsu	930E-5	320	2*	110	2*	115

56/80R63 RIGID DUMP TRUCK USAGE CHART

For Standard Earthmover Service: <2.5 mile, < 30 mph



Manufacturer	Model	Bucket (cu. yd.)	Front Minimum Ply Rating	Front Minimum Inflation (psi)	Rear Minimum Ply Rating	Rear Minimum Inflation (psi)
Belaz	75600	350	2*	100	2*	105
Cat	795 AC	345	2*	105	2*	105
Komatsu	960E-1	360	2*	105	2*	105
Komatsu	960E-1K	360	2*	105	2*	105
Komatsu	960E-2	360	2*	105	2*	105
Komatsu	960E-2K	360	2*	105	2*	105
Liebherr	T282C	400	2*	110	2*	110
Liebherr	T284	400	2*	110	2*	110
Terex	MT 5500	360	2*	100	2*	100

Pressure and ply recommendations based on normal quarry operations with standard equipment. For different applications, or modified equipment, please contact OTR Field Engineering for a specific recommendation. Tire damage or failure caused by improper load, ply, speed or inflation practices is not covered by the Titan Tire Warranty Policy.

CT - Contact Titan Technical services

59/80R63 RIGID DUMP TRUCK USAGE CHART

For Standard Earthmover Service: <2.5 mile, < 30 mph



Manufacturer	Model	Bucket (cu. yd.)	Front Minimum Ply Rating	Front Minimum Inflation (psi)	Rear Minimum Ply Rating	Rear Minimum Inflation (psi)
Belaz	75600	350	2*	95	2*	95
Belaz	75601	400	2*	105	2*	105
Belaz	75710	500	2*	105	2*	105
Belaz	75710	515	2*	110	2*	110
CAT	795F AC	345	2*	95	2*	100
Cat	797F	400	2*	110	2*	110
Caterpillar	798 AC	410	2*	110	2*	110
Komatsu	980E-4	407	2*	110	2*	110
Liebherr	T282C	400	2*	105	2*	105
Liebherr	T284	400	2*	105	2*	105
Terex	MT 5500	360	2*	90	2*	90
Terex	MT 6300	400	2*	105	2*	105

Pressure and ply recommendations based on normal quarry operations with standard equipment. For different applications, or modified equipment, please contact OTR Field Engineering for a specific recommendation. Tire damage or failure caused by improper load, ply, speed or inflation practices is not covered by the Titan Tire Warranty Policy.

CT - Contact Titan Technical services

RADIAL TOWED SCRAPER

17.5R25 TOWED SCRAPER USAGE CHART

For Standard Scraper Service: <2.5 mile, < 30 mph



Manufacturer	Model	Payload (cu. yd.)	Tires Per Axle	Tire Min. Ply Rating	Tire Min. Inflation (psi)
Ashland	1410E	14	4	2*	70
Deere	1510DC	15	4	2*	70
Deere	1814DC	18	6	2*	55
Deere	2014DE	20	6	2*	65

Pressure and ply recommendations based on normal quarry operations with standard equipment. For different applications, or modified equipment, please contact OTR Field Engineering for a specific recommendation. Tire damage or failure caused by improper load, ply, speed or inflation practices is not covered by the Titan Tire Warranty Policy.

CT - Contact Titan Technical services

20.5R25 TOWED SCRAPER USAGE CHART

For Standard Scraper Service: <2.5 mile, < 30 mph



Manufacturer	Model	Payload (cu. yd.)	Tires Per Axle	Tire Min. Ply Rating	Tire Min. Inflation (psi)
Ashland	110TS2	11.3	2	2*	75
Ashland	110XL2	11.3	2	CT	CT
Ashland	130TS2	13.3	2	CT	CT
Ashland	220TS4	22	4	CT	CT
Ashland	1410E	14	2	CT	CT
Ashland	2012CS	20	4	2*	75
Ashland	2014CS	20	6	1*	45
Deere	1510DC	15	4	1*	50
Deere	1612DE	16	4	2*	60
Deere	1810DC	18	4	2*	60
Deere	1812DC	18	4	2*	60
Deere	1814DC	18	6	1*	40
Deere	2010DE	20	4	2*	75
Deere	2014DE	20	6	1*	45

Pressure and ply recommendations based on normal quarry operations with standard equipment. For different applications, or modified equipment, please contact OTR Field Engineering for a specific recommendation. Tire damage or failure caused by improper load, ply, speed or inflation practices is not covered by the Titan Tire Warranty Policy.

CT - Contact Titan Technical services

23.5R25 TOWED SCRAPER USAGE CHART

For Standard Scraper Service: <2.5 mile, < 30 mph



Manufacturer	Model	Payload (cu. yd.)	Tires Per Axle	Tire Min. Ply Rating	Tire Min. Inflation (psi)
Ashland	140TS2	14	2	CT	CT
Ashland	140TS2 LGP	14	2	CT	CT
Caterpillar	TS185	19	4	1*	50
Deere	2112DC	21.5	6	1*	40
Deere	2412DE	24	4	2*	70
K-Tec	1228	28	4	2*	70
K-Tec	1228 ADT	28	4	2*	65
K-Tec	1233	33	4	CT	CT
K-Tec	1236	36	4	CT	CT

Pressure and ply recommendations based on normal quarry operations with standard equipment. For different applications, or modified equipment, please contact OTR Field Engineering for a specific recommendation. Tire damage or failure caused by improper load, ply, speed or inflation practices is not covered by the Titan Tire Warranty Policy.

CT - Contact Titan Technical services

26.5R25 TOWED SCRAPER USAGE CHART

For Standard Scraper Service: <2.5 mile, < 30 mph



Manufacturer	Model	Payload (cu. yd.)	Tires Per Axle	Tire Min. Ply Rating	Tire Min. Inflation (psi)
Caterpillar	TS185	19	4	1*	40
Caterpillar	TS225	23.5	4	1*	45
Deere	2112DC (1)	21.5	4	2*	65
Deere	2112DC (2)	21.5	4	1*	45
Deere	2412DE (1)	24	4	2*	75
Deere	2412DE (2)	24	4	1*	55
K-Tec	1233	33	4	2*	65
K-Tec	1237 ADT	40.5	4	CT	CT
K-Tec	1243 ADT	43	4	1*	55

Pressure and ply recommendations based on normal quarry operations with standard equipment. For different applications, or modified equipment, please contact OTR Field Engineering for a specific recommendation. Tire damage or failure caused by improper load, ply, speed or inflation practices is not covered by the Titan Tire Warranty Policy.

CT - Contact Titan Technical services

(1) - Front scraper used in train

(2) - Rear scraper used in train, or single scraper

29.5R25 TOWED SCRAPER USAGE CHART

For Standard Scraper Service: <2.5 mile, < 30 mph



Manufacturer	Model	Payload (cu. yd.)	Tires Per Axle	Tire Min. Ply Rating	Tire Min. Inflation (psi)
Ashland	155TS2	15.5	2	1*	50
Ashland	215TS2	21.5	2	2*	70
Caterpillar	TS180	18.8	2	2*	60
Deere	2010D E	20	2	2*	65
K-Tec	1243 ADT	43	4	1*	40
K-Tec	1263 ADT	63	4	2*	60

Pressure and ply recommendations based on normal quarry operations with standard equipment. For different applications, or modified equipment, please contact OTR Field Engineering for a specific recommendation. Tire damage or failure caused by improper load, ply, speed or inflation practices is not covered by the Titan Tire Warranty Policy.

CT - Contact Titan Technical services

875/65R29 TOWED SCRAPER USAGE CHART

For Standard Scraper Service: <2.5 mile, < 30 mph



Manufacturer	Model	Payload (cu. yd.)	Tires Per Axle	Tire Min. Ply Rating	Tire Min. Inflation (psi)
Caterpillar	TS180	18.8	2	2*	55
Caterpillar	TS220	23.5	2	2*	65
Deere	2412DE	24	2	CT	CT

Pressure and ply recommendations based on normal quarry operations with standard equipment. For different applications, or modified equipment, please contact OTR Field Engineering for a specific recommendation. Tire damage or failure caused by improper load, ply, speed or inflation practices is not covered by the Titan Tire Warranty Policy.

CT - Contact Titan Technical services

RADIAL TRACTOR SCRAPER

23.5R25 TRACTOR SCRAPER USAGE CHART

For Standard Scraper Service: <2.5 mile, < 30 mph



Manufacturer	Model	Payload (cu. yd.)	Front Minimum Ply Rating	Front Minimum Inflation (psi)	Rear Minimum Ply Rating	Rear Minimum Inflation (psi)
Caterpillar	613B	11	1*	50	1*	50
Caterpillar	613C	11	1*	50	1*	50
Caterpillar	613C II	11	1*	50	1*	55
Caterpillar	613G	11	2*	60	1*	55
Deere	762	11	1*	55	1*	55
Deere	762A	11	2*	60	1*	55
Deere	762B	11	2*	60	1*	55
Deere	762B II	14	2*	60	1*	55
Komatsu Dresser	412	11	1*	50	1*	55
Komatsu Dresser	412B	11	1*	55	1*	55

26.5R25 TRACTOR SCRAPER USAGE CHART

For Standard Scraper Service: <2.5 mile, < 30 mph



Manufacturer	Model	Payload (cu. yd.)	Front Minimum Ply Rating	Front Minimum Inflation (psi)	Rear Minimum Ply Rating	Rear Minimum Inflation (psi)
Caterpillar	611	15	2*	65	2*	65
Caterpillar	611C II	15	CT	CT	2*	65
Caterpillar	615	16	2*	70	2*	60
Caterpillar	615C	16	2*	70	2*	60
Caterpillar	615C II	17	2*	75	2*	70
Deere	860	15	2*	55	2*	60
Deere	860A Std	15	2*	60	2*	60
Deere	860A HD	15	2*	65	2*	60
Deere	862	16	2*	65	2*	65
Deere	862B	16	2*	65	2*	65
Fiat Allis	161	15	2*	60	2*	60

Pressure and ply recommendations based on normal quarry operations with standard equipment. For different applications, or modified equipment, please contact OTR Field Engineering for a specific recommendation. Tire damage or failure caused by improper load, ply, speed or inflation practices is not covered by the Titan Tire Warranty Policy.

CT - Contact Titan Technical services

29.5R25 TRACTOR SCRAPER USAGE CHART

For Standard Scraper Service: <2.5 mile, < 30 mph



Manufacturer	Model	Payload (cu. yd.)	Front Minimum Ply Rating	Front Minimum Inflation (psi)	Rear Minimum Ply Rating	Rear Minimum Inflation (psi)
Caterpillar	611	15	1*	55	1*	50
Caterpillar	611C II	15	1*	55	1*	50
Caterpillar	615	16	1*	55	1*	50
Caterpillar	615C	16	1*	55	1*	50
Caterpillar	615C II	17	2*	60	1*	55
Deere	862 w/ Kress bowl	18	1*	55	1*	55
Deere	862 w/ Kress bowl	20	2*	60	2*	60
Deere	862B	16	1*	50	1*	50
Fiat Allis	161	15	1*	45	1*	45
Terex	TS14B	20	2*	65	2*	60
Terex	TS14C	20	2*	65	2*	60
Terex	TS14G	20	2*	70	2*	65

Pressure and ply recommendations based on normal quarry operations with standard equipment. For different applications, or modified equipment, please contact OTR Field Engineering for a specific recommendation. Tire damage or failure caused by improper load, ply, speed or inflation practices is not covered by the Titan Tire Warranty Policy.

CT - Contact Titan Technical services

INDUSTRIAL VEHICLE

OFF THE ROAD TIRE LOADS - USE ON INDUSTRIAL VEHICLES

Tire Size	Ply Rating	Inflation Pressure psi (kPa)	Loads in lbs (kg) at Various Speeds						
			Stationary	Creep	2.5 mph (4 km/h)	5 mph (10 km/h)	10 mph (10 km/h)	12.5 (20 km/h)	15 mph (25 km/h)
14.00-24/25	24	128 (850)	33,500 (15,200)	27,300 (12,400)	24,000 (10,900)	20,900 (9,500)	19,400 (8,800)	18,500 (8,400)	17,900 (8,100)
	28	134 (925)	35,300 (16,000)	28,700 (13,000)	25,400 (11,500)	22,000 (10,000)	20,500 (9,300)	19,400 (8,800)	18,700 (8,500)
16.00-25	32	127 (875)	44,100 (20,000)	35,900 (16,300)	31,700 (14,400)	27,600 (12,500)	25,600 (11,600)	24,300 (11,000)	23,400 (10,600)
	36	141 (975)	48,000 (21,800)	39,000 (17,700)	34,500 (15,600)	30,000 (13,600)	27,900 (12,600)	26,400 (12,000)	25,500 (11,600)
18.00-25	40	138 (950)	60,000 (27,200)	48,700 (22,100)	43,200 (19,600)	37,500 (17,000)	34,800 (15,800)	33,100 (15,000)	32,000 (14,500)
18.00-33	40	138 (950)	70,500 (32,000)	57,300 (26,000)	50,700 (23,000)	44,000 (20,000)	41,000 (18,600)	38,800 (17,600)	37,500 (17,000)
21.00-25	40	120 (825)	72,800 (33,000)	59,100 (26,800)	52,200 (23,700)	45,400 (20,600)	42,300 (19,200)	39,900 (18,100)	38,600 (17,500)
21.00-35	36	109 (750)	81,100 (36,800)	65,900 (29,900)	58,300 (26,400)	50,700 (23,000)	47,200 (21,400)	44,600 (20,200)	43,100 (19,600)
	42	123 (850)	85,800 (38,900)	69,700 (31,600)	61,500 (27,900)	53,600 (24,300)	49,800 (22,600)	47,200 (21,400)	45,600 (20,700)

INDUSTRIAL VEHICLE FOR USE ON SMOOTH FLOORS AND RUNWAYS ONLY

Tire Size	Ply Rating	Inflation Pressure psi (kPa)	Loads in lbs (kg) at Various Speeds						
			Stationary	Creep	2.5 mph (4 km/h)	5 mph (10 km/h)	10 mph (10 km/h)	12.5 (20 km/h)	15 mph (25 km/h)
14.00-24/25	24	145 (1,000)	36,700 (16,700)	32,600 (14,800)	29,600 (13,400)	27,600 (12,500)	26,500 (12,000)	25,800 (11,700)	25,600 (11,600)
	28	145 (1,000)	36,700 (16,700)	32,600 (14,800)	29,600 (13,400)	27,600 (12,500)	26,500 (12,000)	25,800 (11,700)	25,600 (11,600)
16.00-25	32	145 (1,000)	49,700 (22,500)	44,200 (20,000)	40,000 (18,100)	37,300 (16,900)	35,900 (16,300)	35,100 (15,900)	34,500 (15,600)
	36	145 (1,000)	49,700 (22,500)	44,200 (20,000)	40,000 (18,100)	37,300 (16,900)	35,900 (16,300)	35,100 (15,900)	34,500 (15,600)
18.00-25	40	145 (1,000)	63,500 (28,800)	56,500 (25,600)	51,200 (23,200)	47,600 (21,600)	45,900 (20,800)	44,800 (20,300)	44,100 (20,000)
18.00-33	40	145 (1,000)	73,400 (33,000)	65,300 (29,600)	59,200 (26,800)	55,100 (25,000)	53,100 (24,100)	51,800 (23,500)	50,900 (23,100)
21.00-25	40	145 (1,000)	81,800 (37,100)	72,600 (33,000)	65,800 (29,900)	61,300 (27,800)	59,100 (26,800)	57,800 (26,200)	56,900 (25,800)
21.00-35	36	131 (900)	91,300 (41,400)	81,100 (36,800)	73,500 (33,400)	68,400 (31,100)	65,900 (29,900)	64,400 (29,200)	63,400 (28,800)
	42	145 (1,000)	96,300 (43,700)	85,800 (38,900)	77,700 (35,200)	72,300 (32,800)	69,700 (31,600)	68,100 (30,900)	67,000 (30,400)

IMPORTANT: Loads shown in the above table are for the tire only. The rim manufacturer must be consulted to determine the suitability of the rim/wheel for the intended service. Industrial vehicles consist of vehicles such as counterbalanced lift trucks, container handlers, straddle carriers, aircraft tow tractors, pavers, mobile crushers, log stackers, and rough terrain fork lifts.

Creep is defined as movement at very slow speed, not over 200 ft (60 m) in 30 minutes. During creep motion loads on tires are very high. Consideration must be given to the type of surface over which the equipment is traveling.

Smooth floors and runways are defined as paved or protected surfaces which are free of undulations, obstructions, or discontinuities.

OTHER INFLATION TABLES

LOADS FOR E-7 TIRES IN PAVING SERVICE



14.00-20DT											
Inflation	kPA (psi)	75 (11)	100 (15)	125 (18)	150 (22)	175 (25)	200 (29)	240 (35)	250 (36)	275 (40)	300 (44)
Load	kg (lbs)	2,060 (4,540)	2,500 (5,520)	2,800 (6,150)	3,150 (6,950)	3,450 (7,600)	3,750 (8,250)	4,125 (9,100)	4,250 (9,350)	4,500 (9,900)	4,750 (10,500)
Ply Rating		4			6			8			10
LOADS AT OTHER SPEEDS											
65 km/h (40 mph)	kg (lbs)	1,195 (2,634)	1,450 (3,197)	1,624 (3,580)	1,827 (4,028)	2,001 (4,411)	2,175 (4,795)	2,392.5 (5,274)	2,465 (5,434)	2,610 (5,754)	2,755 (6,074)
50 km/h (30 mph)	kg (lbs)	1,400 (3,090)	1,700 (3,750)	1,900 (4,190)	2,140 (4,720)	2,350 (5,180)	2,550 (5,620)	2,810 (6,190)	2,890 (6,370)	3,060 (6,750)	3,230 (7,120)
25 km/h (15 mph)	kg (lbs)	1,650 (3,640)	2,000 (4,410)	2,240 (4,940)	2,520 (5,560)	2,760 (6,080)	3,000 (6,610)	3,300 (7,280)	3,400 (7,500)	3,600 (7,940)	3,800 (8,380)
20 km/h (12.5 mph)	kg (lbs)	1,730 (3,810)	2,100 (4,630)	2,350 (5,180)	2,650 (5,840)	2,900 (6,390)	3,150 (6,940)	3,470 (7,650)	3,570 (7,870)	3,780 (8,330)	3,990 (8,800)
15 km/h (10 mph)	kg (lbs)	1,790 (3,950)	2,180 (4,810)	2,440 (5,380)	2,740 (6,040)	3,000 (6,610)	3,260 (7,190)	3,590 (7,910)	3,700 (8,160)	3,920 (8,640)	4,130 (9,100)
10 km/h (5 mph)	kg (lbs)	2,060 (4,540)	2,500 (5,520)	2,800 (6,150)	3,150 (6,950)	3,450 (7,600)	3,750 (8,250)	4,125 (9,100)	4,250 (9,350)	4,500 (9,900)	4,750 (10,500)
4 km/h (2.5 mph)	kg (lbs)	2,370 (5,220)	2,880 (6,350)	3,220 (7,100)	3,620 (7,980)	3,970 (8,750)	4,310 (9,500)	4,740 (10,450)	4,890 (10,780)	5,180 (11,420)	5,460 (12,040)
Creep	kg (lbs)	2,680 (5,910)	3,250 (7,160)	3,640 (8,020)	4,100 (9,040)	4,490 (9,900)	4,880 (10,760)	5,360 (11,820)	5,530 (12,190)	5,850 (12,900)	6,180 (13,620)
Stationary	kg (lbs)	3,300 (7,280)	4,000 (8,820)	4,480 (9,880)	5,040 (11,110)	5,520 (12,170)	6,000 (13,230)	6,600 (14,550)	6,800 (14,990)	7,200 (15,870)	7,600 (16,750)

16.00-24DT												
Inflation	kPA (psi)	75 (11)	100 (15)	125 (18)	150 (22)	175 (25)	200 (29)	240 (35)	250 (36)	275 (40)	300 (44)	
Load	kg (lbs)	3750 (8250)	4500 (9900)	5000 (11000)	5600 (12300)	6150 (13600)	6700 (14800)	7500 (16500)	7500 (16500)	8000 (17600)	8500 (18700)	
Ply Rating		4	6			8			10		12	
LOADS AT OTHER SPEEDS												
65 km/h (40 mph)	kg (lbs)	2,180 (4,810)	2,610 (5,750)	2,900 (6,390)	3,250 (7,160)	3,570 (7,870)	3,890 (8,580)	4,350 (9,590)	4,350 (9,590)	4,640 (10,230)	4,930 (10,870)	
50 km/h (30 mph)	kg (lbs)	2,550 (5,620)	3,060 (6,750)	3,400 (7,500)	3,810 (8,400)	4,180 (9,220)	4,560 (10,050)	5,100 (11,240)	5,100 (11,240)	5,440 (11,990)	5,780 (12,740)	
25 km/h (15 mph)	kg (lbs)	3,000 (6,610)	3,600 (7,940)	4,000 (8,820)	4,480 (9,880)	4,920 (10,850)	5,360 (11,820)	6,000 (13,230)	6,000 (13,230)	6,400 (14,110)	6,800 (14,990)	
20 km/h (12.5 mph)	kg (lbs)	3,150 (6,940)	3,780 (8,330)	4,200 (9,260)	4,700 (10,360)	5,170 (11,400)	5,630 (12,410)	6,300 (13,890)	6,300 (13,890)	6,720 (14,810)	7,140 (15,740)	
15 km/h (10 mph)	kg (lbs)	3,260 (7,190)	3,920 (8,640)	4,350 (9,590)	4,870 (10,740)	5,350 (11,790)	5,830 (12,850)	6,530 (14,400)	6,530 (14,400)	6,960 (15,340)	7,400 (16,310)	
10 km/h (5 mph)	kg (lbs)	3,750 (8,250)	4,500 (9,900)	5,000 (11,000)	5,600 (12,300)	6,150 (13,600)	6,700 (14,800)	7,500 (16,500)	7,500 (16,500)	8,000 (17,600)	8,500 (18,700)	
4 km/h (2.5 mph)	kg (lbs)	4,310 (9,500)	5,180 (11,420)	5,750 (12,680)	6,440 (14,200)	7,070 (15,590)	7,700 (16,980)	8,630 (19,030)	8,630 (19,030)	9,200 (20,280)	9,780 (21,560)	
Creep	kg (lbs)	4,880 (10,760)	5,850 (12,900)	6,500 (14,330)	7,280 (16,050)	8,000 (17,640)	8,710 (19,200)	9,750 (21,490)	9,750 (21,490)	10,400 (22,930)	11,050 (24,360)	
Stationary	kg (lbs)	6,000 (13,230)	7,200 (15,870)	8,000 (17,640)	8,960 (19,750)	9,840 (21,690)	10,720 (23,630)	12,000 (26,460)	12,000 (26,460)	12,800 (28,220)	13,600 (29,980)	

18.00-25DT																					
Inflation	kPA (psi)	75 (11)	100 (15)	125 (18)	150 (22)	175 (25)	200 (29)	240 (35)	250 (36)	275 (40)	300 (44)	325 (47)	350 (51)	375 (54)	400 (58)	425 (62)	450 (65)	475 (69)	500 (73)		
Load	kg (lbs)	3875 (8,550)	4625 (10,200)	5300 (11,700)	5800 (12,800)	6300 (13,900)	6,900 (15,200)	7,750 (17,100)	7,750 (17,100)	8,250 (18,200)	8,750 (19,300)	9,250 (20,400)	9,500 (20,900)	10,000 (22,000)	10,300 (22,700)	10,600 (23,400)	11,200 (24,700)	11,500 (25,400)	11,800 (26,000)		
Ply Rating		4			6			8		10		12		14		16		18		20	
LOADS AT OTHER SPEEDS																					
65 km/h (40 mph)	kg (lbs)	2,250 (4,960)	2,610 (5,750)	2,990 (6,590)	3,360 (7,410)	3,650 (8,050)	4,000 (8,820)	4,350 (9,590)	4,500 (9,920)	4,790 (10,560)	5,080 (11,200)	5,220 (11,510)	5,510 (12,150)	5,800 (12,790)	5,970 (13,160)	6,150 (13,560)	6,320 (13,930)	6,670 (14,700)	6,840 (15,080)		
50 km/h (30 mph)	kg (lbs)	2,640 (5,820)	3,060 (6,750)	3,500 (7,720)	3,940 (8,690)	4,280 (9,440)	4,690 (10,340)	5,100 (11,240)	5,270 (11,620)	5,610 (12,370)	5,950 (13,120)	6,120 (13,490)	6,460 (14,240)	6,800 (14,990)	7,000 (15,430)	7,210 (15,900)	7,410 (16,340)	7,820 (17,240)	8,020 (17,680)		
25 km/h (15 mph)	kg (lbs)	3,100 (6,830)	3,600 (7,940)	4,120 (9,080)	4,640 (10,230)	5,040 (11,110)	5,520 (12,170)	6,000 (13,230)	6,200 (13,670)	6,600 (14,550)	7,000 (15,430)	7,200 (15,870)	7,600 (16,750)	8,000 (17,640)	8,240 (18,170)	8,480 (18,690)	8,720 (19,220)	9,200 (20,280)	9,440 (20,810)		
20 km/h (12.5 mph)	kg (lbs)	3,260 (7,190)	3,780 (8,330)	4,330 (9,550)	4,870 (10,740)	5,290 (11,660)	5,800 (12,790)	6,300 (13,890)	6,510 (14,350)	6,930 (15,280)	7,350 (16,200)	7,560 (16,670)	7,980 (17,590)	8,400 (18,520)	8,650 (19,070)	8,900 (19,620)	9,160 (20,190)	9,660 (21,300)	9,910 (21,850)		
15 km/h (10 mph)	kg (lbs)	3,370 (7,430)	3,920 (8,640)	4,480 (9,880)	5,050 (11,130)	5,480 (12,080)	6,000 (13,230)	6,530 (14,400)	6,740 (14,860)	7,180 (15,830)	7,610 (16,780)	7,830 (17,260)	8,270 (18,230)	8,700 (19,180)	8,960 (19,750)	9,220 (20,330)	9,480 (20,900)	10,010 (22,070)	10,270 (22,640)		
10 km/h (5 mph)	kg (lbs)	3,875 (8,550)	4,625 (10,200)	5,300 (11,700)	5,800 (12,800)	6,300 (13,900)	6,900 (15,200)	7,750 (17,100)	7,750 (17,100)	8,250 (18,200)	8,750 (19,300)	9,250 (20,400)	9,500 (20,900)	10,000 (22,000)	10,300 (22,700)	10,600 (23,400)	11,200 (24,700)	11,500 (25,400)	11,800 (26,000)		
4 km/h (2.5 mph)	kg (lbs)	4,460 (9,830)	5,180 (11,420)	5,920 (13,050)	6,670 (14,700)	7,240 (15,960)	7,930 (17,480)	8,630 (19,030)	8,910 (19,640)	9,490 (20,920)	10,060 (22,180)	10,350 (22,820)	10,930 (24,100)	11,500 (25,350)	11,840 (26,100)	12,190 (26,870)	12,530 (27,620)	13,220 (29,140)	13,570 (29,920)		
Creep	kg (lbs)	5,040 (11,110)	5,850 (12,900)	6,700 (14,770)	7,540 (16,620)	8,190 (18,060)	8,970 (19,780)	9,750 (21,490)	10,080 (22,220)	10,730 (23,660)	11,380 (25,090)	11,700 (25,790)	12,350 (27,230)	13,000 (28,660)	13,390 (29,520)	13,780 (30,380)	14,170 (31,240)	14,950 (32,960)	15,340 (33,820)		
Stationary	kg (lbs)	6,200 (13,670)	7,200 (15,870)	8,240 (18,170)	9,280 (20,460)	10,080 (22,220)	11,040 (24,340)	12,000 (26,460)	12,400 (27,340)	13,200 (29,100)	14,000 (30,860)	14,400 (31,750)	15,200 (33,510)	16,000 (35,270)	16,480 (36,330)	16,960 (37,390)	17,440 (38,450)	18,400 (40,560)	18,880 (41,620)		

21.00-25DT																							
Inflation	kPA (psi)	150 (22)	175 (25)	200 (29)	240 (35)	250 (36)	275 (40)	300 (44)	325 (47)	350 (51)	375 (54)	400 (58)	425 (62)	450 (65)	475 (69)	500 (73)	525 (76)	550 (80)	575 (83)				
Load	kg (lbs)	7,500 (16,530)	8,250 (18,190)	9,000 (19,840)	10,000 (22,050)	10,000 (22,050)	10,600 (23,370)	11,200 (24,690)	11,800 (26,010)	12,500 (27,560)	12,850 (28,330)	13,200 (29,100)	14,000 (30,860)	14,500 (31,970)	14,500 (31,970)	15,000 (33,100)	15,500 (34,200)	16,000 (35,300)	16,500 (36,400)				
Ply Rating		8		10		12		14		16		18		20		22		24		26		28	
LOADS AT OTHER SPEEDS																							
65 km/h (40 mph)	kg (lbs)	4,350 (9,590)	4,790 (10,560)	5,220 (11,510)	5,800 (12,790)	5,800 (12,790)	6B150 (13,560)	6,500 (14,330)	6,840 (15,080)	7,250 (15,980)	7,450 (16,420)	7,660 (16,890)	8,120 (17,900)	8,410 (18,540)	8,410 (18,540)	8,700 (19,180)	8,990 (19,820)	9,280 (20,460)	9,570 (21,100)				
50 km/h (30 mph)	kg (lbs)	5,100 (11,240)	5,610 (12,370)	6,120 (13,490)	6,800 (14,990)	6,800 (14,990)	7B210 (15,900)	7,620 (16,800)	8,020 (17,680)	8,500 (18,740)	8,740 (19,270)	8,980 (19,800)	9,520 (20,990)	9,860 (21,740)	9,860 (21,740)	10,200 (22,490)	10,540 (23,240)	10,880 (23,990)	11,220 (24,740)				
25 km/h (15 mph)	kg (lbs)	6,000 (13,230)	6,600 (14,550)	7,200 (15,870)	8,000 (17,640)	8,000 (17,640)	8,480 (18,690)	8,960 (19,750)	9,440 (20,810)	10,000 (22,050)	10,280 (22,660)	10,560 (23,280)	11,200 (24,690)	11,600 (25,570)	11,600 (25,570)	12,000 (26,460)	12,400 (27,340)	12,800 (28,220)	13,200 (29,100)				
20 km/h (12.5 mph)	kg (lbs)	6,300 (13,890)	6,930 (15,280)	7,560 (16,670)	8,400 (18,520)	8,400 (18,520)	8,900 (19,620)	9,410 (20,750)	9,910 (21,850)	10,500 (23,150)	10,790 (23,790)	11,090 (24,450)	11,760 (25,930)	12,180 (26,850)	12,180 (26,850)	12,600 (27,780)	13,020 (28,700)	13,440 (29,630)	13,860 (30,560)				
15 km/h (10 mph)	kg (lbs)	6,530 (14,400)	7,180 (15,830)	7,830 (17,260)	8,700 (19,180)	8,700 (19,180)	9,220 (20,330)	9,740 (21,470)	10,270 (22,640)	10,880 (23,990)	11,180 (24,650)	11,480 (25,310)	12,180 (26,850)	12,620 (27,820)	12,620 (27,820)	13,050 (28,770)	13,490 (29,740)	13,920 (30,690)	14,360 (31,660)				
10 km/h (5 mph)	kg (lbs)	7,500 (16,530)	8,250 (18,190)	9,000 (19,840)	10,000 (22,050)	10,000 (22,050)	10,600 (23,370)	11,200 (24,690)	11,800 (26,010)	12,500 (27,560)	12,850 (28,330)	13,200 (29,100)	14,000 (30,860)	14,500 (31,970)	14,500 (31,970)	15,000 (33,100)	15,500 (34,200)	16,000 (35,300)	16,500 (36,400)				
4 km/h (2.5 mph)	kg (lbs)	8,630 (19,030)	9,490 (20,920)	10,350 (22,820)	11,500 (25,350)	11,500 (25,350)	12,190 (26,870)	12,880 (28,400)	13,570 (29,920)	14,370 (31,680)	14,780 (32,580)	15,180 (33,470)	16,100 (35,490)	16,680 (36,770)	16,680 (36,770)	17,250 (38,030)	17,830 (39,310)	18,400 (40,560)	18,980 (41,840)				
Creep	kg (lbs)	9,750 (21,490)	10,730 (23,660)	11,700 (25,790)	13,000 (28,660)	13,000 (28,660)	13,780 (30,380)	14,560 (32,100)	15,340 (33,820)	16,250 (35,820)	16,710 (36,840)	17,160 (37,830)	18,200 (40,120)	18,850 (41,560)	18,850 (41,560)	19,500 (42,990)	20,150 (44,420)	20,800 (45,860)	21,450 (47,290)				
Stationary	kg (lbs)	12,000 (26,460)	13,200 (29,100)	14,400 (31,750)	16,000 (35,270)	16,000 (35,270)	16,960 (37,390)	17,920 (39,510)	18,880 (41,620)	20,000 (44,090)	20,560 (45,330)	21,120 (46,560)	22,400 (49,380)	23,200 (51,150)	23,200 (51,150)	24,000 (52,910)	24,800 (54,670)	25,600 (56,440)	26,400 (58,200)				

HIGH FLOTATION TIRES USED IN AGRICULTURAL, FORESTRY, AND OFF-THE-ROAD SERVICE



Tire Size	Speed (mph)	TIRE LOAD LIMITS (LBS) AT VARIOUS COLD INFLATION PRESSURES (PSI)											
		10	15	20	25	30	35	40	45	50	55	60	65
66X44.00-25NHS	30	6,000	7,600 (6)	9,100	10,200	11,400	12,800	13,600 (16)	14,300	15,700 (20)	16,500	17,100	18,200 (26)
	20	6,700	8,500	10,200	11,400	12,800	14,300	15,200	16,000	17,600	18,500	19,200	20,400
	10	7,900	10,000	12,000	13,500	15,000	16,900	18,000	18,900	20,700	21,800	22,600	24,000
	5	9,500	12,000	14,400	16,100	18,000	20,200	21,500	22,600	24,800	26,100	27,000	28,800
	Creep	12,000	15,200	18,200	20,400	22,800	25,600	27,200	28,600	31,400	33,000	34,200	36,400
	Stationary	15,900	20,100	24,100	27,000	30,200	33,900	36,000	37,900	41,600	43,700	45,300	48,200
68X50.00-32NHS	30	5,840	7,400	8,800	9,900	11,000	12,300 (16)	13,200	14,300 (20)	---	---	---	---
	20	6,550	8,300	9,850	11,100	12,300	13,800	14,800	16,000	---	---	---	---
	10	7,700	9,750	11,600	13,100	14,500	16,200	17,400	18,900	---	---	---	---
	5	9,250	11,700	13,900	15,600	17,400	19,400	20,900	22,600	---	---	---	---
	Creep	11,700	14,800	17,600	19,800	22,000	24,600	26,400	28,600	---	---	---	---
	Stationary	15,500	19,600	23,300	26,200	29,200	32,600	35,000	37,900	---	---	---	---
66X43.00-25NHS	30	5,840	7,400	8,800	9,900 (10)	11,000 (12)	12,300 (14)	13,200 (16)	13,900	14,800 (20)	15,700	16,500	17,600 (26)
	20	6,550	8,300	9,850	11,100	12,300	13,800	14,800	15,600	16,600	17,600	18,500	19,700
	10	7,700	9,750	11,600	13,100	14,500	16,200	17,400	18,300	19,500	20,700	21,800	23,200
	5	9,250	11,700	13,900	15,600	17,400	19,400	20,900	22,000	23,400	24,800	26,100	27,800
	Creep	11,700	14,800	17,600	19,800	22,000	24,600	26,400	27,800	29,600	31,400	33,000	35,200
	Stationary	15,500	19,600	23,300	26,200	29,200	32,600	35,000	36,800	39,200	41,600	43,700	46,600
66X43.00-26NHS	30	5,840	7,400	8,800	9,900	11,000	12,000 (14)	13,200 (16)	13,900	14,800 (20)	15,700	16,500	17,100 (26)
	20	6,550	8,300	9,850	11,100	12,300	13,400	14,800	15,600	16,600	17,600	18,500	19,200
	10	7,700	9,750	11,600	13,100	14,500	15,800	17,400	18,300	19,500	20,700	21,800	22,600
	5	9,250	11,700	13,900	15,600	17,400	19,000	20,900	22,000	23,400	24,800	26,100	27,000
	Creep	11,700	14,800	17,600	19,800	22,000	24,000	26,400	27,800	29,600	31,400	33,000	34,200
	Stationary	15,500	19,600	23,300	26,200	29,200	31,800	35,000	36,800	39,200	41,600	43,700	45,300
67X34.00-25NHS	30	5,840	7,400	8,800	10,200	11,400 (10)	12,300	13,200 (14)	14,300	15,200	16,100 (20)	---	---
	20	6,550	8,300	9,850	11,400	12,800	13,800	14,800	16,000	17,000	18,000	---	---
	10	7,700	9,750	11,600	13,500	15,000	16,200	17,400	18,900	20,100	21,300	---	---
	5	9,250	11,700	13,900	16,100	18,000	19,400	20,900	22,600	24,000	25,400	---	---
	Creep	11,700	14,800	17,600	20,400	22,800	24,600	26,400	28,600	30,400	32,200	---	---
	Stationary	15,500	19,600	23,300	27,000	30,200	32,600	35,000	37,900	40,300	42,700	---	---
67X34.00-26NHS	30	5,840	7,400	8,800	9,900	11,000	12,000	13,200 (14)	13,900	14,800	15,700 (20)	---	---
	20	6,550	8,300	9,850	11,100	12,300	13,400	14,800	15,600	16,600	17,600	---	---
	10	7,700	9,750	11,600	13,100	14,500	15,800	17,400	18,300	19,500	20,700	---	---
	5	9,250	11,700	13,900	15,600	17,400	19,000	20,900	22,000	23,400	24,800	---	---
	Creep	11,700	14,800	17,600	19,800	22,000	24,000	26,400	27,800	29,600	31,400	---	---
	Stationary	15,500	19,600	23,300	26,200	29,200	31,800	35,000	36,800	39,200	41,600	---	---
DH73x44.00-32 VA73x43.00-32	30	6,800	8,550	10,200	11,700	12,800 (12)	14,300	15,200 (16)	16,500	17,600 (20)	---	---	---
	20	7,600	9,600	11,400	13,100	14,300	16,000	17,000	18,500	19,700	---	---	---
	10	9,000	11,300	13,500	15,400	16,900	18,900	20,100	21,800	23,200	---	---	---
	5	10,700	13,500	16,100	18,500	20,200	22,600	24,000	26,100	27,800	---	---	---
	Creep	13,600	17,100	20,400	23,400	25,600	28,600	30,400	33,000	35,200	---	---	---
	Stationary	18,000	22,700	27,000	31,000	33,900	37,900	40,300	43,700	46,600	---	---	---

CONTINUES ON NEXT PAGE

HIGH FLOTATION TIRES USED IN AGRICULTURAL, FORESTRY, AND OFF-THE-ROAD SERVICE CONTINUED 													
Tire Size	Speed (mph)	TIRE LOAD LIMITS (LBS) AT VARIOUS COLD INFLATION PRESSURES (PSI)											
		10	15	20	25	30	35	40	45	50	55	60	65
DH73x50.00-32	30	6,950	8,800	10,500	12,000	13,200	14,800 (16)	15,700	17,100 (20)	----	----	----	----
	20	7,800	9,850	11,800	13,400	14,800	16,600	17,600	19,200	----	----	----	----
	10	9,150	11,600	13,900	15,800	17,400	19,500	20,700	22,600	----	----	----	----
	5	11,000	13,900	16,600	19,000	20,900	23,400	24,800	27,000	----	----	----	----
	Creep	13,900	17,600	21,000	24,000	26,400	29,600	31,400	34,200	----	----	----	----
	Stationary	18,400	23,300	27,800	31,800	35,000	39,200	41,600	45,300	----	----	----	----

Notes:

- The small index numbers denote ply ratings for which accompanying loads and inflations are maximum.
- For variable loading operations where load increase or decrease, the load per tire when the vehicle is empty must be less than 40% of the load on the tire when the vehicle is fully loaded. Maximum load may not be carried for more than one mile before unloading operation starts. Loading or unloading must be completed within one mile.
- For operations at other speeds with no change in inflation pressure, the loads in the above table may be changed as follows:
- Creep Speed is a travel rate of not over 200 feet in a 30 minute period

MAXIMUM SPEED (mph)	% CHANGE IN LOADS
20	+12
10	+32
5	+58
*Creep	+100
Stationary	+165

RADIAL PLY TERRA

High Flotation Tires Used in Agricultural, Logging, and Off-the-Road Service
TIRES USED AS SINGLES WITH NO SUSTAINED HIGH TORQUE

TIRE SIZE	TIRE LOAD LIMITS (LBS) AT VARIOUS COLD INFLATION PRESSURES (PSI)														
	6	9	12	15	17	20	23	26	29	32	35	38	41	44	46
1000/50R25	5,360	6,400	7,400	8,550	9,650 (159)	10,700	11,700 (166)	12,300	13,200	13,600	13,900 (172)	14,800	15,200	16,100	16,500 (178)
1050/50R25	5,840	6,950	8,050	9,350	10,500 (162)	11,700	12,800 (169)	13,600	14,300	14,800	15,200 (175)	16,100	16,500 (178)	----	----
1050/50R32	6,400	7,600	8,800	10,200	11,400 (165)	12,800	13,900 (172)	14,800	15,700	16,100	16,500 (178)	----	----	----	----
LSW1100/45R46	10,200*	12,300*	14,300	16,500	18,200 (181)	20,400	22,700 (189)	24,000	24,700	26,000	26,800 (195)	----	----	----	----
LSW1100/45R46 (Muck Master)	8,800*	10,500*	12,300	13,900	15,700 (176)	17,600	19,300 (183)	20,400	21,500	22,000	23,400 (190)	----	----	----	----
1250/40R25	6,150	7,400	8,800	9,900	11,000 (164)	12,300	13,600 (171)	14,300	15,200 (175)	15,700	16,500 (178)	17,100	17,600 (180)	----	----
1250/35R32	6,000	7,400	8,550	9,650	11,000 (164)	12,000	13,200 (170)	14,300	14,800	15,700	16,100 (177)	----	----	----	----
1250/50R32	8,550	10,200	11,700	13,600	15,200 (175)	17,100	18,700 (182)	19,800	20,400 (185)	21,500	22,000 (188)	----	----	----	----
1250/35R42	6,800	8,250	9,650	11,000	12,300 (168)	13,600	15,200 (175)	16,100	16,500 (178)	17,600	18,200 (181)	----	----	----	----
LSW1250/35R46	9,900*	12,000*	13,900	16,100	18,200 (181)	19,800	22,000 (188)	23,400	24,700	25,400	26,800 (195)	--	--	--	--
LSW1250/40R46	9,650*	11,700*	13,600	15,200	17,100 (179)	19,300	20,900 (186)	22,700	23,400	24,700	25,400 (193)	----	----	----	----
LSW1400/30R46	10,500*	12,300*	14,800	16,500	18,700 (182)	20,900	22,700 (189)	24,000	25,400	26,800	27,600 (196)	----	----	----	----

Notes:

- For Loads at other conditions see notes 1, 2, and 3 on previous page.
- The number in parentheses is tire's load index
- The loads with an asterisk are for calculation of dual loads only.

DIAGONAL (BIAS) PLY TIRES USED FOR SKID-STEER/MINI-LOADER SERVICE



TIRE SIZE	TIRE LOAD LIMITS (LBS) AT VARIOUS COLD INFLATION PRESSURES (PSI)													
	20	25	30	35	40	45	50	55	60	65	70	75	80	
10-16.5 NHS	----	----	2,760 (4)	3,020	3,260	3,500 (5)	3,720	3,930	4,140 (8)	----	----	----	----	
12-16.5 NHS	----	----	3,560	3,900	4,220 (6)	4,520	4,810 (8)	5,080	5,350	5,600 (10)	5,850	6,090	6,330 (12)	
14-17.5 NHS	----	----	4,820 (6)	5,270	5,700 (8)	6,110	6,490	6,870 (10)	----	----	----	----	----	
15-19.5 NHS	----	----	6,130 (6)	6,710	7,250 (8)	7,770	8,260 (10)	8,740	9,190 (12)	9,360	10,060 (14)	10,470	10,880 (16)	
31x15.50-15 NHS	2,700 (4)	3,050	3,395 (6)	3,695	4,015	4,360 (8)	----	----	----	----	----	----	----	

Notes:

- Number in (parentheses) denote ply rating or load range to which loads and inflations are maximum.
- For 10 MPH service, the above loads must be reduced 21% at the same pressures.

DIAGONAL (BIAS) PLY LOG SKIDDER DRIVE WHEEL TIRES USED IN LOGGING OR FORESTRY SERVICE (OTHER THAN ON CABLE OR GRAPPLE SKIDDERS) TIRES USED AS SINGLES



MAX SPEED 20 MPH (30 KM/H)		TIRE LOAD LIMITS (LBS) AT VARIOUS COLD INFLATION PRESSURES (PSI)											
Tire Size	psi	20	25	30	35	40	45	50					
	kPa	140	170	210	240	*275/280	310	340					
16.9-30	lbs	4,400	5,080	5,680 (10)	141	6,150	6,600 (14)	146	----	----			
	kg	2,000	2,300	2,575 (10)		2,800	3,000 (14)						
18.4-26	lbs	4,940	5,680 (10)	141	6,400 (12)	145	----	----	----	----			
	kg	2,240	2,575 (10)		2,900 (12)								
18.4-34	lbs	5,680	6,400 (10)	145	----	----	----	----	----				
	kg	2,575	2,900 (10)										
23.1-26	lbs	7,150 (10)	149	8,250	9,100 (14)	157	9,900 (16)	10,700 (20)	163	----	----		
	kg	3,250 (10)		3,750	4,125 (14)		4,500 (16)	4,875 (20)					
24.5-32	lbs	8,800	9,900 (12)	160	11,000 (16)	164	12,000 (18)	13,200 (20)	170	----	----		
	kg	4,000	4,500 (12)		5,000 (16)		5,450 (18)	6,000 (20)					
LOW SECTION HEIGHT													
28L-26	lbs	8,250 (12)	154	9,350 (14)	158	10,500 (16)	162	11,400 (20)	165	----	----	----	
	kg	3,750 (12)		4,250 (14)		4,750 (16)		5,150 (20)					
30.5L-32	lbs	10,500 (12)	162	11,700 (16)	166	13,200 (20)	170	14,300	15,700 (26)	176	16,500	17,600 (32)	180
	kg	4,750 (12)		5,300 (16)		6,000 (20)		6,500	7,100 (26)		75,00	8,000 (32)	
DH35.5L-32	lbs	13,900 (16)	172	16,100 (20)	177	17,600	183	19,300 (26)	20,900 (30)	186			
	kg	6,300 (16)		7,300 (20)		8,000		8,750 (26)	9,500 (30)				

TIRE TYPE NOMENCLATURE	
CODE NO.	TIRE TYPE
LS-2	INTERMEDIATE TREAD
LS-3	DEEP TREAD

Notes:

- Figures in parentheses denote ply rating or load range for which bold face loads and inflations are maximum. Numbers after ply ratings are Load Index numbers.
- For shipping purposes, tire inflation may be increased to 30 psi (210 kPa). Inflation pressures must be adjusted to correct operating pressure before skidder is removed from carrier. Consult tire manufacturer for minimum tire shipping pressure.
- "Tire Load Limit" for log skidders is defined as the maximum load for an individual tire due to the total radial forces imposed on the tire DURING OPERATION. This maximum load includes total vehicle weight with accessories and weight transfer. For grapple and cable skidders, refer to table below.
- For load and carry type of logging operations such as loaders equipped with log forks and feller bunchers, with maximum speed of 5 mph (10 km/h), above tire load limits may be increased 50% with 5 psi (35 kPa) increase in inflation pressure. Maximum length of carry is 500 feet (150 m).
- When used as duals, tire loads must be reduced. Multiply figures in table by .88.
- Consult rim and wheel manufacturer for rims for this type of service.
- For transport service and operations that do not require sustained high torque, the following load limits apply (table to the right):

MAX SPEED	% CHANGE IN LOADS	CHANGE IN INFL. PRESSURE
Stationary	+170	+5 PSI (30 kPa)
10 MPH (15 KM/H)	+20	NONE
15 MPH (25 KM/H)	+15	NONE
20 MPH (30 KM/H)	NONE	NONE
25 MPH (40 KM/H)	-10	NONE

DIAGONAL (BIAS) PLY LOG SKIDDER DRIVE WHEEL TIRES USED ON CABLE OR GRAPPLE SKIDDERS TIRES USED AS SINGLES



MAX SPEED 5 MPH (10 KM/H)		TIRE LOAD LIMITS (LBS) AT VARIOUS COLD INFLATION PRESSURES (PSI)											
Tire Size	psi	25	30	35	40	45	50	55					
	kPa	170	210	240	*275/280	310	340	380					
18.4-26	lbs	6,950	8,050 (10)	153	9,100 (12)	157	---	---	---	---			
	kg	3,150	3,650 (10)		4,125 (12)		---	---	---	---			
18.4-34	lbs	8,050	9,100 (10)	157	---	---	---	---	---				
	kg	3,650	4,125 (10)		---	---	---	---	---				
23.1-26	lbs	9,900 (10)	160	11,700	12,800 (14)	169	13,900 (16)	172	15,200 (20)	175	---	---	
	kg	4,500 (10)		5,300	5,800 (14)		6,300 (16)		6,900 (20)		---	---	
24.5-32	lbs	12,300	13,900 (12)	172	15,200 (16)	175	17,100 (18)	179	18,700 (20)	182	---	---	
	kg	5,600	6,300 (12)		6,900 (16)		7,750 (18)		8,500 (20)		---	---	
LOW SECTION HEIGHT													
28L-26	lbs	11,700 (12)	166	13,200 (14)	14,800 (16)	174	16,100 (20)	177	---	---	---		
	kg	5,300 (12)		6,000 (14)	6,700 (16)		7,300 (20)		---	---	---		
30.5L-32	lbs	14,800 (12)	174	16,500 (16)	18,700 (20)	182	19,800	188	22,000 (26)	188	23,400	24,700 (32)	192
	kg	6,700 (12)		7,500 (16)	8,500 (20)		9,000		10,000 (26)		10,600	11,200 (32)	
DH35.5L-32	lbs	19,800 (16)	184	22,700 (20)	24,700	195	26,800 (26)	195	29,100 (30)	198	---	---	
	kg	9,000 (16)		10,300 (20)	11,200		12,150 (26)		13,200 (30)		---	---	

Notes:

- Figures in parentheses denote ply rating or load range for which bold face loads and inflations are maximum.
- For shipping purposes, tire inflation may be increased to 30 psi (210 kPa). Inflation pressures must be adjusted to correct operating pressure before skidder is removed from carrier. Consult tire manufacturer for minimum tire shipping pressure.
- "Tire Load Limit" for log skidders is defined as the maximum load for an individual tire due to the total radial forces imposed on the tire DURING OPERATION. This maximum load includes total vehicle weight with accessories, plus load increases due to log winching or grappling loads and weight transfer.
- The table above applies only to log skidder tires used on cable or grapple skidders with a maximum speed of 5 mph (10 km/h). For use on other types of logging or forestry equipment or at speeds greater than 5 mph (10 km/h) refer to the table at the top of this page.
- When used as duals, tire loads must be reduced. Multiply figures in table by .88.
- Consult rim and wheel manufacturer for rims for this type of service.

MATERIAL HANDLING LOADS

Size	Service Condition Application Speed			Counterbalanced Lift Truck		Industrial Vehicle Loads			
	Ply Rating	Catalog Number	PSI (kPa)	Front/Drive	Rear/Steer	Smooth Floor Only		Other Than Smooth Floor	
				up to 10 mph (15 km/h)	up to 15 mph (25 km/h)	5 mph (10 km/h)	10 mph (15 km/h)	5 mph (10 km/h)	10 mph (15 km/h)
				lbs (kg)	lbs (kg)	lbs (kg)	lbs (kg)	lbs (kg)	lbs (kg)
TITAN T40									
32x12-15 NHS	20	44P226	145 (1,000)	13,400 (6,080)	10,200 (4,625)	10,200 (4,625)	8,050 (3,650)	9,150 (4,150)	7,250 (3,290)
35x15-15 NHS	24	44P376	145 (1,000)	17,600 (8,000)	13,200 (6,000)	13,200 (6,000)	10,500 (4,750)	12,000 (5,450)	9,650 (4,375)
35x15-15 NHS	28	44P377	145 (1,000)	17,600 (8,000)	13,200 (6,000)	13,200 (6,000)	10,500 (4,750)	12,000 (5,450)	9,650 (4,375)
TITAN T44									
44x18-20 NHS	32	44T3K1	145 (1,000)	26,800 (12,150)	20,400 (9,250)	20,400 (9,250)	16,100	18,200 (8,250)	14,300 (6,500)
42x21-22 NHS	32	44T3J5	145 (1,000)	33,300 (15,105)	25,300 (11,475)	25,300 (11,475)	20,000 (9,070)	22,800 (10,340)	18,000 (8,165)
TITAN PWT									
7.00-12 NHS	12	44P212	125 (860)	5,995 (2,720)	4,555 (2,065)	4,555 (2,065)	3,595 (1,630)	4,100 (1,860)	3,235 (1,465)
7.50-16 NHS	12	44P2K8	115 (790)	8,015 (3,635)	6,090 (2,760)	6,090 (2,760)	4,810 (2,180)	5,485 (2,490)	4,330 (1,965)
8.25-15 NHS	12	44P231	105 (720)	8,680 (3,935)	6,595 (2,990)	6,595 (2,990)	5,210 (2,365)	5,935 (2,690)	4,685 (2,125)
8.25-15 NHS	14	44P2D5	120 (830)	9,385 (4,255)	7,135 (3,235)	7,135 (3,235)	5,630 (2,555)	6,420 (2,910)	5,070 (2,300)
250-15 NHS	16	4492H1	135 (930)	9,450 (4,285)	7,200 (3,265)	7,200 (3,265)	5,680 (2,575)	6,450 (2,925)	5,100 (2,315)
250-15 NHS	18	44P2H2	145 (1,000)	9,900 (4,500)	7,400 (3,350)	7,400 (3,350)	5,840 (2,650)	6,800 (3,075)	5,360 (2,430)
28x12-15 NHS	20	44P262	145 (1,000)	10,700 (5,300)	8,050 (3,650)	8,050 (3,650)	6,400 (2,900)	7,150 (3,250)	5,680 (2,575)
28x9-15 NHS	12	44P2B5	120 (830)	6,880 (3,120)	5,230 (2,370)	5,230 (2,370)	4,125 (1,870)	4,705 (2,135)	3,715 (1,685)
28x9-15 NHS	14	44P2D3	140 (970)	7,530 (3,415)	5,720 (2,595)	5,720 (2,595)	4,515 (2,050)	5,150 (2,335)	4,065 (1,845)
29x8-15 NHS	12	44P216	125 (860)	6,870 (3,115)	5,220 (2,370)	5,220 (2,370)	4,120 (1,870)	4,700 (2,130)	3,710 (1,685)
32x15-15 NHS	24	44P3G7	145 (1,000)	15,700 (7,100)	11,700 (5,300)	11,700 (5,300)	9,350 (4,250)	10,700 (4,875)	8,550 (3,875)
36x11-15 NHS	16	44P2F9	115 (790)	12,290 (5,575)	9,340 (4,235)	9,340 (4,235)	7,375 (3,345)	8,405 (3,815)	6,635 (3,010)
36x11-15 NHS	24	44P6F9	145 (1,000)	14,100 (6,395)	10,700 (4,855)	10,700 (4,855)	8,450 (3,835)	9,650 (4,375)	7,600 (3,445)
TITAN INDUSTRIAL DEEP TREAD (IDT)									
5.70/5.00-8 NHS	10	4542A1	145 (1,000)	2,760 (1,250)	2,090 (950)	2,090 (950)	1,650 (750)	1,870 (850)	1,480 (670)
6.90 /6.00-9 NHS	10	454204	125 (860)	3,715 (1,685)	2,820 (1,280)	2,820 (1,280)	2,230 (1,010)	2,540 (1,150)	2,000 (905)
6.50-10 NHS	10	454263	115 (790)	4,225 (1,915)	3,210 (1,455)	3,210 (1,455)	2,535 (1,150)	2,890 (1,310)	2,280 (1,035)
7.50-10 NHS	12	454287	120 (830)	5,655 (2,565)	4,300 (1,950)	4,300 (1,950)	3,395 (1,540)	3,870 (1,755)	3,055 (1,385)
7.00-12 NHS	12	454212	125 (860)	5,995 (2,720)	4,555 (2,065)	4,555 (2,065)	3,595 (1,630)	4,100 (1,860)	3,235 (1,465)
7.00-12 NHS	14	4542D7	145 (1,000)	6,535 (2,965)	4,970 (2,255)	4,970 (2,255)	3,920 (1,780)	4,470 (2,030)	3,530 (1,600)
7.50-15 NHS	12	454269	115 (790)	7,690 (3,490)	5,845 (2,650)	5,845 (2,650)	4,615 (2,095)	5,260 (2,385)	4,150 (1,880)
8.25-15 NHS	12	454231	105 (720)	8,680 (3,935)	6,595 (2,990)	6,595 (2,990)	5,210 (2,365)	5,935 (2,690)	4,685 (2,125)
8.25-15 NHS	14	4542D5	120 (830)	9,385 (4,255)	7,135 (3,235)	7,135 (3,235)	5,630 (2,555)	6,420 (2,910)	5,070 (2,300)
29x8-15 NHS	12	454216	125 (860)	6,870 (3,115)	5,220 (2,370)	5,220 (2,370)	4,120 (1,870)	4,700 (2,130)	3,710 (1,685)
30X8-15 NHS	12	454251	125 (860)	6,940 (3,150)	5,275 (2,395)	5,275 (2,395)	4,165 (1,890)	4,745 (2,150)	3,745 (1,700)
TITAN INDUSTRIAL SERVICE									
5.70-8 NHS	6	40B206	90 (620)	---	---	1,530 (695)	1,210 (550)	1,415 (640)	1,115 (505)
5.70-8 NHS	8	40B208	120 (830)	---	1,830 (830)	1,830 (830)	1,445 (655)	1,675 (760)	1,320 (600)

CONTINUES ON NEXT PAGE

MATERIAL HANDLING LOADS CONTINUED

Size	Service Condition Application Speed			Counterbalanced Lift Truck		Industrial Vehicle Loads					
	Ply Rating	Catalog Number	PSI (kPa)	Front/Drive	Rear/Steer	Smooth Floor Only			Other Than Smooth Floor		
				up to 10 mph (15 km/h)	up to 15 mph (25 km/h)	PSI (kPa)	5 mph (10 km/h)	10 mph (15 km/h)	PSI (kPa)	5 mph (10 km/h)	10 mph (15 km/h)
				lbs (kg)	lbs (kg)		lbs (kg)	lbs (kg)		lbs (kg)	lbs (kg)
TITAN PWT											
9.00-20 NHS	12	44P218	95 (660)	11,800 (5,350)	8,950 (4,060)	104 (720)	10,600 (4,810)	10,200 (4,625)	87 (600)	7,850 (3,560)	6,800 (3,085)
9.00-20 NHS	14	44P2E8	110 (760)	12,800 (5,805)	9,750 (4,425)	122 (840)	11,540 (5,235)	11,120 (5,045)	102 (700)	8,550 (3,880)	7,450 (3,380)
10.00-20 NHS	16	44P2E9	115 (790)	14,910 (6,765)	11,330 (5,140)	131 (900)	13,750 (6,235)	13,250 (6,010)	109 (750)	10,200 (4,625)	8,850 (4,015)
11.00-20 NHS	16	44P2E2	110 (760)	15,845 (7,185)	12,040 (5,460)	126 (870)	14,450 (6,555)	13,900 (6,305)	105 (720)	10,700 (4,855)	9,300 (4,220)
12.00-20 NHS	18	44P2E3	115 (790)	18,600 (8,435)	14,100 (6,395)	131 (900)	17,300 (7,845)	16,650 (7,550)	109 (750)	12,800 (5,805)	11,150 (5,060)
12.00-20 NHS	20	44P2A7	130 (900)	19,900 (9,025)	15,100 (6,850)	144 (990)	18,350 (8,325)	17,700 (8,030)	120 (830)	13,600 (6,170)	11,850 (5,375)
TITAN TT472											
10.00-20 NHS	18	472224	130 (900)	16,000 (7,260)	12,200 (5,535)	148 (1,020)	14,850 (6,735)	14,300 (6,485)	123 (850)	11,000 (4,990)	9,570 (4,340)
12.00-20 NHS	20	4722A7	130 (900)	19,900 (9,025)	15,100 (6,850)	144 (990)	18,350 (8,325)	17,700 (8,030)	120 (830)	13,600 (6,170)	11,850 (5,375)

APPROVED RIM CONTOURS

BIAS EARTHMOVING		
Tire size	Recommended Rim	Approved Rims
13.00-24TG (12 PR)	9.00GR	10.00VA, 8.00TG
13.00-24TG (14 PR)	8.00TG	10.00VA
13.00-24TG (16 PR)	10.00VA	
14.00-24TG (12 PR)	9.00GR	10.00VA, 8.00TG
14.00-24TG (14 PR)	8.00TG	10.00VA
14.00-24TG (16 PR)	10.00VA	
14.00-24NHS*	10.00W	
14.00-25NHS*	10.00/1.5	
LSW330-851	851x254LSW	

* Tube Type

PAVER/SAND		
Tire size	Recommended Rim	Approved rims
14.00-20DT	10.00W	
16.00-24DT	10.00VA	
18.00-25DT	10.00/1.5	
21.00-25DT	15.00/3.0	

BIAS GRADER SERVICE		
Tire size	Recommended Rim	Approved rims
13.00-24TG (12 PR)	9.00GR	10.00VA, 8.00TG
13.00-24TG (14 PR)	8.00TG	10.00VA
13.00-24TG (16 PR)	10.00VA	
14.00-24TG (12 PR)	9.00GR	10.00VA, 8.00TG
14.00-24TG (14 PR)	8.00TG	10.00VA
14.00-24TG (16 PR)	10.00VA	
16.00-24TG (12 PR)	10.00VA	9.00GR
16.00-24TG (14 PR & UP)	10.00VA	
LSW 330-851	851x254LSW	
LSW 360-851	851x254LSW	
LSW 395-851	851x317LSW	

BIAS LOADER/DOZER SERVICES		
Tire size	Recommended Rim	Approved rims
400/70-20	W14L	14, 13, 13SDC
LSW 400-648	648x356LSW	
21.00-25DT	15.00/3.0	

BIAS CONTAINER HANDLING		
Tire size	Recommended Rim	Approved rims
14.00-24NHS	10.00W	

BIAS UNDERGROUND MINE/MATERIAL HANDLING		
Tire size	Recommended Rim	Approved rims
6.00-9NHS (6.90-9NHS)	4.00E	
6.50-10NHS	5.00F	5.50F
7.50-10NHS (12 PR & BELOW)	5.50F	5.00F
7.50-10NHS (14 PR & UP)	6.00SP	6.00ST
7.00-12NHS	5.00S	
7.50-15NHS	6.0	6.5
8.25-15NHS	6.5	6.50BD
9.00-20NHS	7.0	7.5
10.00-20NHS	7.5	8
11.00-20NHS	8.0	8.5
12.00-20NHS	8.5	8.0, 9.0
12.00-24NHS	8.5	9
14.00-24NHS	10.00W	
29x8-15NHS	5.5	5.50BD
30x8-15NHS	6.0	5.50BD, 5.5
32x12-15NHS	9.75	9.75, 9.75BD
35x15-15NHS** (16 PR & BELOW)	10.50	11.00BD, 11.00
35x15-15NHS** (20PR & UP)	11.50	11.00BD, 11.00
28x9-15NHS	7.0	7.00BD
28x12-15NHS	9.75BD	
32x15-15NHS**	11.50	10.50, 11.00BD, 11.0
36x11-15NHS	7.5	7.50BD
44x18.00-20NHS	15.00T	
42x21.00-22NHS	18.00	

** Tubeless

BIAS FORESTRY		
Tire size	Recommended Rim	Approved rims
18.4-26	DW16A	
18.4-34	DW16A	DW15A
23.1-26	DW20A	DW20B
24.5-32 (12 PR & BELOW)	DH21	DW21A, DW21B, DH21B, DH21H, DH21HB
24.5-32 (16 PR & UP)	DH21	DH21B, DH21H, DH21HB
28L-26	DW25A	DW25B
30.5L-32 (12 PR & BELOW)	DH27	DW27A, DW27B, DH27B, DH27H, DH27HB
30.5L-32 (16 PR & UP)	DH27	DH27B, DH27H, DH27HB
DH35.5L-32	DH31	DH31B, DH31H, DH31HB
66x43.00-25NHS	36.0TH	
67x34.00-25NHS	30.0TH	
DH73x44.00-32	DH36	DH36B, DH36H, DH36HB, 36DWM
DH73x50.00-32	DH44	DW44A, DW44B, WWDWM, DH44H, DH44HB, DH44B

APPROVED RIM CONTOURS CONTINUED

RADIAL BACKHOE		
Tire size	Recommended Rim	Approved Rims
340/80R18	11	W10H, W11
400/70R18	W13	W12
440/80R24	W14L	W15L
440/80R28	W14L	W15L
460/70R24	W14L	W15L
480/80R26	W15L	W16L, DW15A, DW16A
500/70R24	W16L	W15L, DW16A, W16A
500/85R24	W16L	W15L, DW16A, W16A
540/70R24	W16L	DW18A, W18L, W16A, DW16A
19.5LR24	DW16L	DW16A, W16A

BIAS BACKHOE		
Tire size	Recommended Rim	Approved Rims
9.00-10HS	6.00F (2-piece)	5.50F (2- piece)
11.00-16SL	W8L	8LB, W10L, 10LB
12.4-16	W10L	10LB
14.9-24	W13	W12
16.9-24	W15L	
16.9-28	W15L	W14L
16.9-30	W15L	DW15A, W14L, DW14A
18.4-24	W16L	W15L, W16A
18.4-26	DW16A	W15L, DW15A
18.4-28	W16L	W16A, W15L
17.5L-24	W15L	
19.5L-24 (10 PR & BELOW)	DW16A	W16L, W15L
19.5L-24 (12 PR & UP)	DW16A	
11L-15SL	8LB	10LB
11L-16SL	W8L	8LB, W10L, 10LB
21L-24 (10 PR & BELOW)	DW18A	W18L
21L-24 (12 PR & UP)	DW18A	
21L-28 (10 PR)	DW18A	W18L
21L-28 (14 PR)	DW18A	DW18L
480/45-17	16.00	
420/70-24	W13	W12, W14L
14.5/75-16.1SL	16.1xW11C	
10.5/80-18	W9	9, W8
12.5/80-18	W9	11
LSW495-762	30xDW15A	
LSW320-597	597x267LSW	

BIAS SKID STEER		
Tire size	Recommended Rim	Approved rims
5.70-12NHS	4.50I-70	4.50I-90, 5JA
7.00-15SS	5.50F	
8.25-15NHS	6LB	
10-16.5NHS	8.25 (15°)	
12-16.5NHS	9.75 (15°)	
14-17.5NHS	10.50 (15°)	
15-19.5NHS	11.75 (15°)	12.25 (15°)
18x8.50-10	7.00 I-55	7.00 I-70, I-90
20x8.00-10NHS	7.00 I-70	6.00E, 7.00E, 7.00I-55, 7.00I-90
23x8.50-12NHS	7.00 I-70	7.00 I-90, 7JA
23x8.50-14NHS	7.00 I-70	7.00 I-90, 7JA
26x12.0-12NHS	10.50 I-70	81/2JA, 10.50 I-90, 8.50 I-70, 8.50 I-90
27x8.50-15NHS	7JA	
27x10.50-15NHS	8LB	
27x12.5-15NHS	10LB	
28x8.50-15NHS	7JA	
30.5x12.00-16.5NHS	9.75 (15°)	
31x15.50-15NHS	13LB	
33x14.50-16.5NHS	12.00 (15°)	
33x15.50-16.5NHS	12.00 (15°)	
43x16.00-20NHS	W14LH	W14L
LSW265-521	521x210LSW	
LSW305-546	546x248LSW	
LSW350-597	597x267LSW	
LSW385-648	648x317LSW	

** Tubeless

BIAS COMPACTOR		
Tire size	Recommended Rim	Approved rims
6.00-16NHS	4.00E	4.25KA, 4.50E
8.5/90-15K	5.50F	
7.50-15NHS	6.0	6.5
9.00-20NHS	7.0	7.5
11.00-20NHS	8.0	8.5

TIRE HANDLING

CAUTION DO NOT DAMAGE BEAD

1. Do not insert forks inside wheel hole.
2. Lift with rope sling or round fork or padded forks having 6-inch minimum diameter **-OR-**
3. Lift on the outside circumference only.

TIRE STORAGE

OTR Tires are designed to withstand the usage conditions of their respective application, but in order to achieve their full performance potential they must be maintained appropriately, which includes the condition in which they are stored in order to minimize the chance of experiencing an ozone/weather cracking condition.

The rubber compounds that are exposed to the atmosphere are formulated to resist deterioration caused by ozone. Although, said rubber compound properties evolve due to their service and storage conditions. Improper storage may result in various tire conditions to develop including weather/ozone cracking (also known as veneer cracking, dry rot, weather checking, or crazing).

In order to help avoid potential tire degradation, maximize tire performance, and ultimately prevent premature removals, Titan recommends the following best practices:

Unmounted Tire or Mounted Tire/Wheel Assembly

Area

- Indoor (preferred)
- Outdoors (if necessary):
 - Protect with an opaque waterproof covering with air vent openings to prevent creating a heat box or steam bath effect
- **AVOID:**
 - Storing near ozone generating sources which causes rubber to oxidize:
 - Sources of ozone include: Electric motors/machines, engine exhaust, welding equipment, battery chargers, transformers, and mercury vapor lamps. Other equipment that may produce sparks or electrical discharges should also be avoided.
 - Do not exceed an 0.08ppm ozone level
 - Exposure to volatile solvents/substances and/or petroleum based products:
 - Oil, fuels, lubricants, acids, disinfectants, and other chemicals should not be kept in storage room
 - Higher altitudes; this can accelerate tire degradation

Ground Surface Conditions:

- Clean, cool, dry, dark, and well ventilated, but with minimal circulating air
- Store tires raised off the storage area's surface to minimize exposure to moisture or damage, such as on a pallet or a storage rack
- Pallets should be free of damage, protruding nails, and/or sharp burrs and have a flat, smooth surface to further avoid unwanted indentations to the tire
- Remove any water that has collected in an unmounted tire prior to mounting
- **AVOID:**
 - Placing on black asphalt or other heat absorbent surfaces
 - Storing adjacent to highly reflective surfaces (i.e. sand or snow covered ground)
 - Storing on piers or other open/unprotected areas

Temperature/Lighting

- Ideally, a storage temperature of approximately 72°F (22°C) should be targeted
- **AVOID:**
 - Above 50°C (122°F) as this condition may be accelerated.
 - Direct contact with piping and radiators
 - Storing next to heaters, open flames, or other incandescent units
 - Direct sunlight
 - Strong artificial light with a high ultra-violet content



INFLATION PRESSURE

Under Inflation

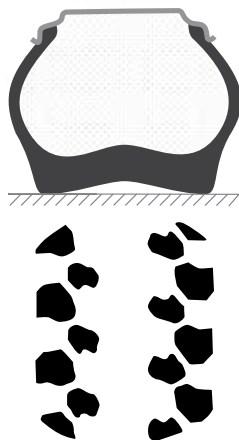

Proper Inflation

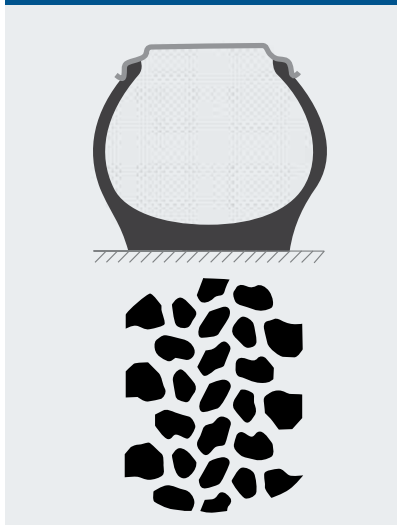

Over Inflation

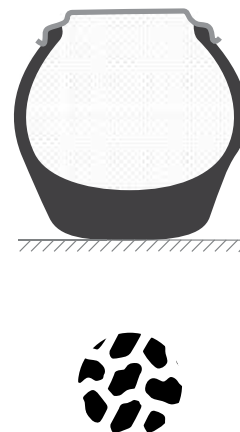

Lower & Mid Sidewall Awl Holes

Air/gas seeping through vent holes in the lower and mid sidewall is normal in any fabric working Off-The-Road (OTR) tire and should never be interpreted as the cause of internal tire inflation pressure loss.

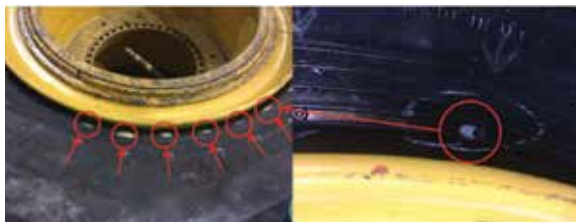

THE PURPOSE OF AWL HOLE

Fabric ply tires can build-up gases under pressure within the tire cord body. There can be several reasons for this build-up of intracarcass pressure in the tire casing:

- Air can be trapped in the tire casing during the tire building process. It is forced into the cords during curing, and is completely normal.
- Air can go into the casing during vehicle operation as no tire innerliner is totally resistant to air permeation. This happens regardless of innerliner gauge or material.
- Tests have shown that a working tire will build 25 to 35 lbs. pressure in the carcass (Internal pressure within the actual plies).

In order to help OTR tires bleed air/gas from their casings, they are awled in the lower, mid, and/or upper sidewall only down to the plies. These awling holes allow this carcass pressure buildup to escape.

How to Investigate Pressure Loss

The only way to properly investigate an air loss complaint is by checking air pressure daily. Depending on when tire air loss was first documented, follow the procedures below:

If a drop in inflation pressure is recorded shortly after initial mount up, the following should be checked:

- O-Ring
 - Fit and air retention capabilities
 - Was it pinched during installation?
 - Was it butted together and glued to create an O-Ring?
- Valve-Stem Hardware
 - Ensure all components are tight, including valve stem
 - Ensure the cap is on tight as it is the primary air seal. It also helps to prevent dirt, dust, and water damage to the core
- Proper bead seating
 - It can sometimes take several days to become fully seated
- Proper rim parts
 - Clean, not mixing manufacturers
 - Correct flange height for the tire
- If the above are inspected without issue, dismount the tire and check for anomalies
 - If an awl hole had been drilled through, it would lose air immediately

If a drop in inflation pressure is recorded long after initial mount up, the following should be checked:

- Look for a puncture in the tire, which could go through the innerliner
- O-Ring
 - Fit and air retention capabilities
 - In overload conditions, O-Rings can be pinched
- Valve-Stem Hardware
 - Make sure all components are tight, including valve stem
 - Ensure the cap is on tight as it is the primary air seal. It also helps to prevent dirt, dust, and water damage to the cores
- Check rim components for any signs of wear/failure

MEASURING TREAD WEAR

Tires With Tread Depth Indicator

Two Scribes

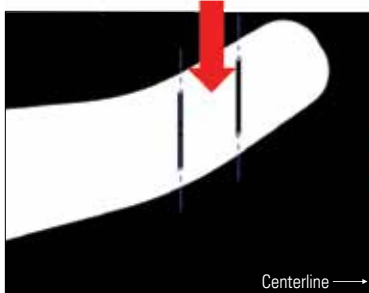

Measure in between scribes.

One Scribe

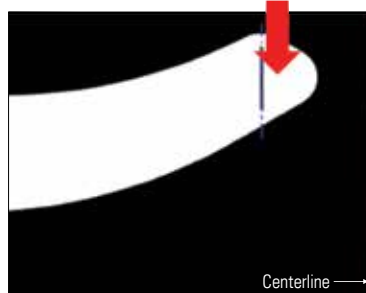

Measure next to the scribe on centerline side.

Smooth Tires

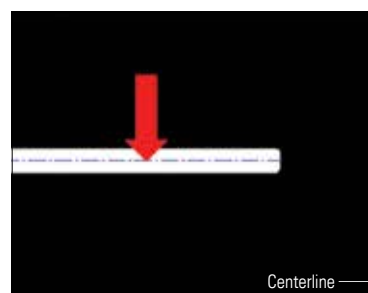

Measure in indicator groove.

Tires Without Tread Depth Indicator

Logger Lug, LS 150, HK 458

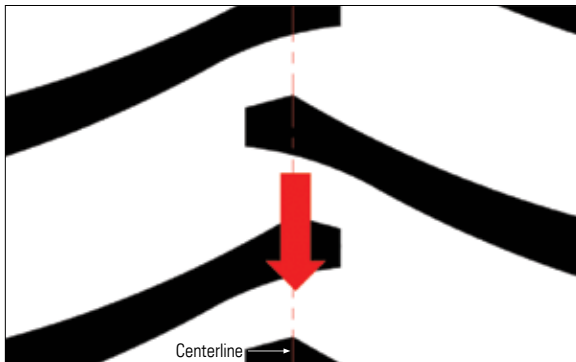

Open tread pattern tires measure at centerline. If there is a tie-bar at centerline, add the height of the tie-bar.

Logger Lug YL33R3 & YL3R65

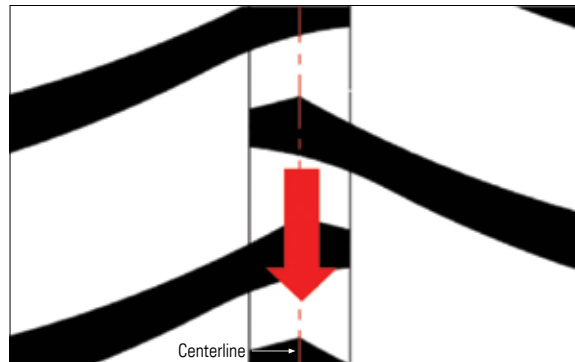

Logger Lug with tie-bar (YL33R3, YL3R65) measure at centerline and add 66/32 for full depth

Super LCM

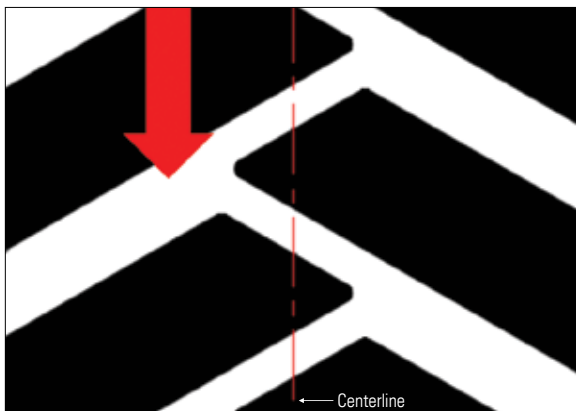

Measure 1/3 width of tread from centerline.

CH 150 & CM 150

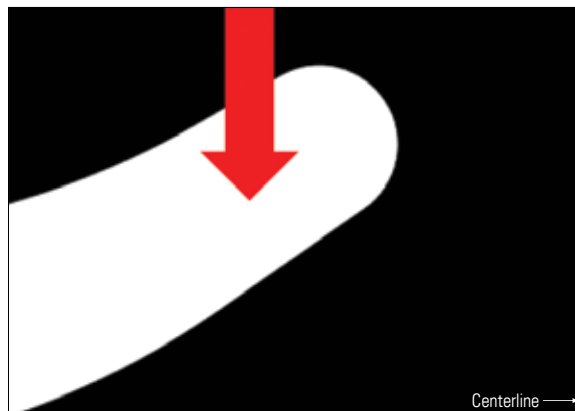

Measure, halfway between centerline and shoulder.

IMPORTANT SAFETY INFORMATION

WARNING

To prevent **SERIOUS INJURY** or **DEATH**:

- **ONLY** specially trained personnel, using the proper procedures and tools, shall service tires.
- **ALWAYS** read and fully understand all procedures before tire/wheel servicing.
- **ALWAYS STAND CLEAR** of trajectory zone.
- **ONLY** assemble a tire and rim after you have positively identified and correctly matched the tire and rim diameter
- **ALWAYS** use a tire cage or other approved restraining devices when inflating tires.
- **NEVER** exceed the recommended inflation pressure on the sidewall of the tire you are inflating.

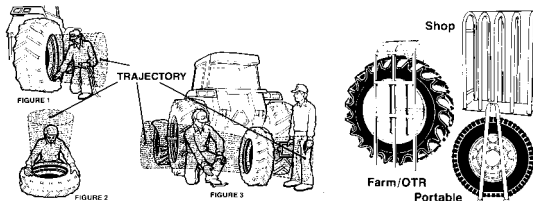

Your employer is responsible for providing proper procedures and training for tire technicians. See Occupational Safety and Health Administration (OSHA), 29 CFR 1910.177, Servicing of Single Piece and Multi-Piece Rim Wheels.

Additional information go to www.titan-intl.com or call 1 (800) 872-2327

1. Personal Protective Equipment

ALWAYS wear adequate protective eye-wear (or face shield), protective footwear, and ear protection.



2. For all tires

- ALWAYS follow the blocking, jacking, or cribbing of the vehicle/equipment guidance provided by the vehicle/equipment manufacturer.
- **ONLY** use properly diluted tire lubricant (nonflammable vegetable or soap-based). NEVER use concentrated tire lubricant or it may not completely evaporate and residue could cause tire to slip. NEVER use petroleum based lubricants, silicone or antifreeze.
- NEVER use starter fluid, ether, gasoline, or other flammable materials and/or accelerants to lubricate the beads of a tire or there may be an explosive separation of the tire/wheel during servicing or during use.
- NEVER inflate over the maximum psi as indicated on each tire or the manufacturer's guidance.
- When seating tire beads, NEVER exceed the maximum psi for the tire or 40 psi for any multi-piece rim or 35 psi for single piece rim.
- NEVER stand, lean, or reach over the tire rim/wheel assembly in the tire cage or other approved restraining devices during inflation.

3. Single Piece Rims (Drop Center Rims)

3.1 Terminology

1. Rim Size (Nominal Bead Seat Diameter)
2. Rim Width
3. Rim Inside Dia.
4. Bead Seat Area
5. Flange
6. Flange Height
7. Valve Hole (Location and size can vary)

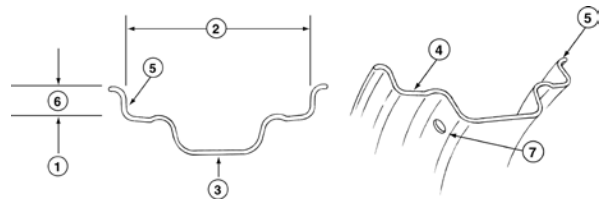

3. Single Piece Rims (Drop Center Rims)

3.2 Demounting

Tools Required

Cap and core removal tools, hydraulic bead unseating tool, two tire irons (36" if ON vehicle or 18" if OFF vehicle), wire and diluted tire lubricant.

1.	Remove any fluid fill from tire.
2.	Always remove the valve core and exhaust all air. Use exhaust muffler if applicable. Check valve stem not plugged by inserting a wire through the valve stem. For tube type tires, remove the rim nut and push valve through valve hole. NOTE: ALWAYS deflate both tires, if ON vehicle AND vehicle has a dual tire assembly.
3.	Use hydraulic bead unseating tool between the tire bead and rim flange and force the bead off the bead seat. If ON vehicle: Unseat bead on both sides of rim. If OFF vehicle: Lay tire and rim down with the narrow ledge of the rim closer to the floor and unseat bead. Then turn tire and rim over with narrow ledge (or short side of rim) up and unseat bead.
4.	Lubricate the tire bead area and rim flange with diluted tire mounting lubricant.
5.	If ON vehicle: Lock the wheel with the valve at the top. At the bottom, force the outside bead into the well. At the top, insert both 36" tire irons under the bead and pry the bead over the rim flange. If OFF vehicle: Force the part of the bead that is directly across from the valve into the well. Starting at the valve, insert both 18" tire irons under the bead and pry the bead over the rim flange.

CONTINUES ON NEXT PAGE

6. After the first section of the bead is over the rim flange, use one tire iron to pry the next section over the flange. Continue prying tire over rim flange until the entire tire bead is on the outside of the rim flange. NOTE: DO NOT attempt to pry too large a section of the bead over the rim flange at one time. Leave one tool in position and place the second about five (5) inches away. Repeat in successive steps until the tire bead is completely unseated. Avoid extremely hard prying, which will damage the tire bead.
7. For tube-type tires, pull the tube out of the casing, starting at the bottom. If OFF vehicle: bring tire and rim upright position before pulling tube out of the tire. If only the tube requires repair or replacement, the tube can be removed, repaired, and replaced in the tire without removing the tire completely from the wheel. Before reinstalling the tube, thoroughly inspect the inside of the tire for damage or other foreign material. Remove any remaining fluid from inside the tire.
8. To completely remove the tire from the rim: If ON vehicle: Insert tire irons under the inside bead at the side of the tire. Pry the inside bead over the rim flange. Before starting, check the bead area on the opposite side of the tire is down in the well of the rim. If OFF vehicle: Turn assembly over so the narrow ledge is closer to the ground and lubricate the second tire bead and rim flange. Before starting, check the bead area on the opposite side of the tire is down in the well of the rim and insert the tire irons under the opposite side of the bead.

3.3 Mounting

WARNING

To prevent **SERIOUS INJURY** or **DEATH**:

- **ALWAYS** check the tire matches the rim diameter designation. **NEVER** mount a tire that is too large or too small for the rim. Rims of different diameters and tapers **CANNOT** be interchanged.
- **ALWAYS** remove water and foreign material from tire.
- **INSPECT** rim for damage, pitting from corrosion, cracks or if bent out of shape. If damage is found, **DO NOT** use. Mark or tag as unserviceable and remove from service area.
- **INSPECT** tubes and tires for excessive wear, cracks, tears, punctures, blisters, or other damage. **DO NOT** use if damage is found. Replace with good tube or tire.

Tools Required

Two tire irons (36" if ON vehicle or 18" if OFF vehicle), diluted tire lubricant, wire brush, locking pliers, rubber mallet, valve retrieval tool (tube-type tires), extension hose with in-line gauge and clip-on air chuck, air/water inflation gauge, tire cage or other approved restraining devices.

1. Use a wire brush to clean and inspect rim for fatigue cracks.  If damage is found, DO NOT use. Mark or tag as unserviceable and remove from service area. Replace any cracked, badly worn, damaged and severely rusted rims or wheels. Do not attempt to rework, weld, heat, or braze any rim base or wheel components under any circumstances. Coat the rim with paint or a rust inhibitor if necessary. Follow procedures and safety precautions of the paint manufacturer.
2. Thoroughly lubricate both tire beads and rim flanges with diluted tire mounting lubricant.

3. If ON vehicle: Before placing tire on rim, check valve hole is at the bottom of wheel. Check directional tread tires are mounted for correct rotation direction. To put the tire on the wheel, place the inner bead over the flange at the top. Check bead is not "hung up" on bead seat; instead the bead is in the rim well, while the tire irons and/or rubber mallet are used to work the first bead over the rim. If OFF vehicle: Lay the rim on the floor with the narrow ledge on the top. Check directional tread tires are mounted for correct rotation direction. Push the bottom bead over the rim flange as far as possible. Use 18" tire irons to work the first tire bead completely over the rim flange, taking small bites and being careful not to damage the bead.
4. For tubeless tires, skip to step 7. For tube type tires: If ON vehicle: With the first bead on the rim, pull the tire toward the outside of the rim as far as possible to make room for the tube. Be sure valve is at the bottom of the wheel. Align the stem with the valve hole and starting at the bottom, insert tube into tire. Place the valve in valve hole and screw the rim nut in place. The tube should be partially inflated and areas contacting the rim should be re-lubricated to prevent localized stretching. Check tube is inside rim before proceeding. If OFF vehicle: Partially inflate the tube and insert it into the tire casing with the valve located near the valve hole in the rim. Attach a valve retrieval tool to the valve and thread the tool through the valve hole. NOTE: You may want to use a block to raise the tire to make it easier to insert the tube.
5. Starting opposite the valve, use the tire irons to lift the outer bead up and over the rim flange, then down into the rim well. Be careful not to pinch the tube. If OFF vehicle, locking pliers may be used to prevent tire slipping off the back of the rim.
6. Centering of the tire and rim assembly is extremely important to prevent broken beads. If ON vehicle, with the valve stem at the bottom, lower the jack until the tire is centered on the rim.
7. Place a tire cage or other approved restraining devices over the rim and tire. Using an extension hose with an in-line air gauge and clip-on chuck (with valve core removed), inflate the tire to seat the beads.  NEVER inflate over the maximum psi as indicated on each tire or the manufacturer's guidance. When seating tire beads, NEVER exceed the maximum psi for the tire or 35 psi for single piece rim. Check for concentric centering of tire on rim. For tubeless tires, successful mounting depends on how well the shape of the tire has been maintained. If the beads are in or near their molded position, they can be seated by inflating the tire, through the valve. Where the beads have been squeezed together, the use of an inflator ring (either horizontally or vertically) will be required to provide a seal between the tire bead and rim. If assembly is incorrect, – STOP – DEFLATE – CORRECT THE ASSEMBLY – repeat procedure.
8. If ON vehicle: raise vehicle and rotate wheel assembly so valve at the top (12 o'clock position). If the tire is tube-type, completely deflate by removing the valve core housing to remove buckles and uneven stresses from the tube and flap before re-inflation.
9. If assembly is correct, re-insert the valve core (for tube-type tires) and continue to inflate to recommended pressure
10. Remove tire cage or other approved restraining devices.

4. Three Piece Rims

4.1 Terminology

1. Rim Size (Nominal Bead Seat Diameter)
2. Rim Width
3. Rim Inside Dia.
4. Bead Seat Area
5. Flange-Fixed
6. Flange Height
7. Valve Hole (Location and size can vary)
8. Flange-Removable (Side Ring)
9. Lock Ring
10. O-Ring (For tubeless application only)
11. 28° Mounting Bevel (utilized for demountable application only)
12. Rim Stop Plate (Used for demountable application only; size, shape and location can vary.)
13. O-Ring Groove
14. Lock Ring Groove
15. Gutter Portion of Rim

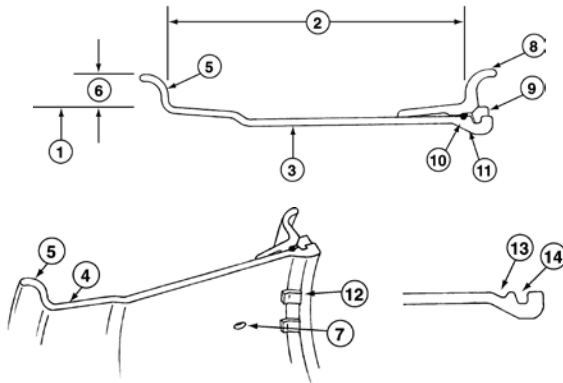

4.2 Demounting

Tools Required

One (1) straight tire iron, two (2) gooseneck tire irons, hydraulic bead unseating tool, diluted tire lubricant, wire and valve core removal tool.

1.	If OFF vehicle: place the assembly on block on the floor with loose side flange side up.
2.	Drive the goose-necked end of two gooseneck tire iron tools between the tire and side flange about five (5) inches apart.
3.	Pry both tools down and out. Leave one tool in position and place the second about five (5) inches away. Repeat in successive steps until the tire bead is completely unseated
4.	After the tire bead is unseated, stand on side flange and tire sidewall to depress the side flange down along the rim base. Pry the lock ring loose, starting at the split then remove the lock ring.
5.	Hold the side flange down with hooked end of gooseneck tire iron to remove the "O" ring from ring groove. Cut and discard the "O" ring and replace with a new "O" ring.
6.	Remove the side flange.
7.	Turn tire and rim over and unseat second bead by inserting both gooseneck tire iron tools between tire and fixed rim flange as in step 3. Repeat steps 2 and 3 until the tire bead is completely broken loose from the rim on the fixed flange side. Lift rim base out of tire.

4.3 Mounting



To prevent **SERIOUS INJURY** or **DEATH**:

- **ALWAYS** check the tire matches the rim diameter designation. **NEVER** mount a tire that is too large or too small for the rim. Rims of different diameters and tapers **CANNOT** be interchanged..
- **ALWAYS** remove water and foreign material from tire.
- **INSPECT** rim for damage, pitting from corrosion, cracks or if bent out of shape. If damage is found, **DO NOT** use. Mark or tag as unserviceable and remove from service area.
- **INSPECT** tubes and tires for excessive wear, cracks, tears, punctures, blisters, or other damage. **DO NOT** use if damage is found and replace with good tube or tire.

Tools Required

Two tire irons (36" if ON vehicle or 18" if OFF vehicle), diluted tire lubricant, wire brush, locking pliers, rubber mallet, valve retrieval tool (tube-type tires), extension hose with in-line gauge and clip-on air chuck, air/water inflation gauge, tire cage or other approved restraining devices.



1.	Use a wire brush to clean the rim base and all components thoroughly. Clean all dirt and rust from inter-locking faces of multi-piece rim components, particularly the gutter sections that hold the lock ring and "O" ring in place.
2.	Inspect rim base and wheel components for cracks, wear, corrosion and damage. <ul style="list-style-type: none"> • If damage is found, DO NOT use. Mark or tag as unserviceable and remove from service area. • Inspect all wheel components to verify the components meet the manufacturer's standards. • Replace any cracked, badly worn, damaged and severely rusted parts and rims. • Do not attempt to rework, weld, heat, or braze any rim base or wheel components under any circumstances. <p>Verify the replacement parts are the correct size, type and manufacturer for the wheel to be assembled.</p>
3.	Coat the rim with paint or a rust inhibitor if necessary. Follow procedures and safety precautions of the paint manufacturer.
4.	Inspect tire for wear, cracks, tears, punctures and other damage. Tires with excessive or uneven wear, cracks, tears, punctures, blisters or other damage may explode during inflation or service. <ul style="list-style-type: none"> • If damage is found, DO NOT use. Mark or tag as unserviceable and remove from service area. Tire should be destroyed and replaced with good tire of correct size, type and manufacturer for assembly, machine, and application. • If concerned about the condition of the rim base, wheel components, or tire - STOP - contact the manufacturer or distributor for assistance.
5.	Install valve on rim. Follow valve manufacturer's recommendations and installation instructions.
6.	If OFF vehicle: place rim base on blocks with fixed flange side down. Lubricate both bead seats with diluted tire lubricant. Place tire over rim base.
7.	Double check the parts and rim base are all compatible. Place side flange over rim base and push straight down with hands as far as possible. Make sure side flange does not bind on rim base.

CONTINUES ON NEXT PAGE

8. Lubricate a new rubber "O" ring. Place "O" ring in groove on one side. Stretch "O" ring and snap it into place. DO NOT roll "O" ring into place.
Lubricate the entire "O" ring area.
For 20" bead diameter and larger or flat base rims, ONLY use water to lube the bead and rim flange areas.
NOTE: You may need to hold the side flange down with the flat end of a gooseneck tire iron to expose the "O" ring groove.
 9. Stand on side flange to position it below both grooves in the rim base and snap lock ring into lock ring (upper) groove. Check lock ring is installed with the correct side facing you.
 10. Check components are correctly assembled and lock ring is fully seated in gutter.
When a driver key is used, make sure the gap in the lock ring is at least 6" away from the driver key.
 11. Place rim and tire in a tire cage or other approved restraining devices during tire inflation. Use a clip-on chuck with an in-line pressure gauge and enough hose so you can stay away from the potential trajectory danger zone.

WITH VALVE CORE REMOVED: Inflate to approximately 3 psi and check for proper engagement of all components.

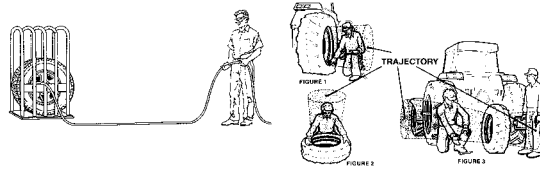
If assembly is correct, install valve core and inflate to recommended pressure.

If assembly is incorrect, STOP – DEFLATE – CORRECT THE ASSEMBLY – AND REPEAT PROCEDURE.
- 
-  **Never attempt to align or seat side flange, lock ring or other components by inflation, hammering, welding, heating or brazing.**

 **Never inflate beyond manufacturer's recommended tire pressure.**
12. Remove tire cage or other approved restraining devices.

16. Knurl (Located on Back Flange Portion of Rim Base and Bead Seat Band tire mating surfaces)
17. Lock Ring Groove (size and shape can vary depending on style of lock ring)
18. Pry Bar Pocket [not shown] (continuous gap entire circumference on some items)

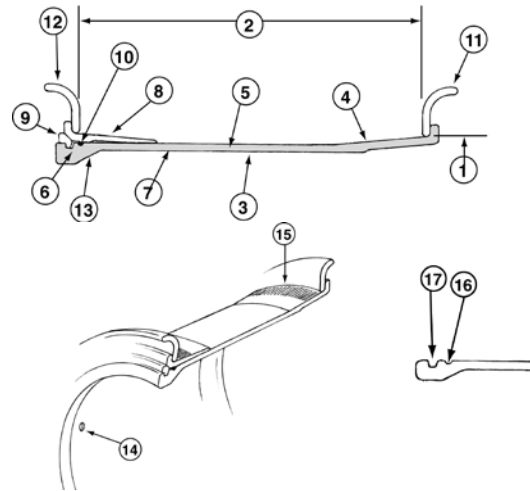

Crimped on Style Driver

1. Lock Ring
2. Crimped on driver
3. Notch in gutter portion of rim
4. Notch in bead seat band

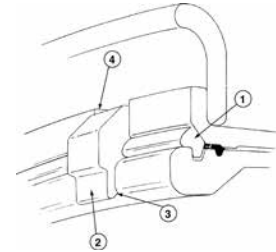

Loose Style Driver

1. Gutter Portion of Rim Base
2. 28° Mounting Bevel
3. Rim Stop Plates (location, style and size can vary)

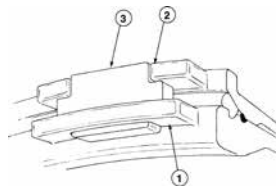

Demountable Type Rims

1. Driver Pocket (welded on gutter portion of rim base)
2. Driver Pocket (welded on bead seat band)
3. Driver Key – See Outboard Driver Keys.

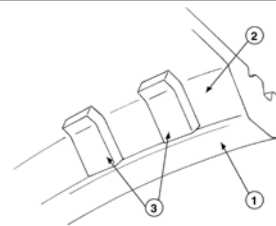

Valve Hole Styles

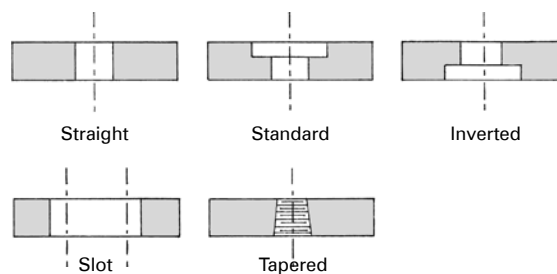

5. Five Piece Rims

5.1 Terminology

1. Rim Size (Bead Seat Diameter)
2. Rim Width
3. Rim Inside Dia.
4. Back Flange Portion of Rim Base
5. Center Band Portion of Rim Base
6. Gutter Band Portion of Rim Base
7. Rim Base (Entire Shaded Area)
8. Bead Seat Band (Removable, Gutter Side only)
9. Lock Ring
10. O-Ring
11. Flange, Inner (Removable)
12. Flange, Outer (Removable) *Note: Inner and Outer Flanges are identical
13. 28° Mounting Bevel (Utilized for demountable application only)
14. Valve Hole (Location, size and configuration can vary)
15. O-Ring Groove

5.1.1 Driver Keys

Driver Keys are used on rims in high torque and/or low inflation pressure applications to help prevent circumferential movement of the rim components. Look for an "M" or "L" near the end of the style designation (part number).

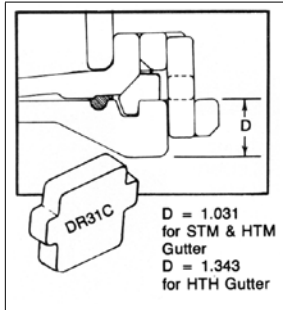
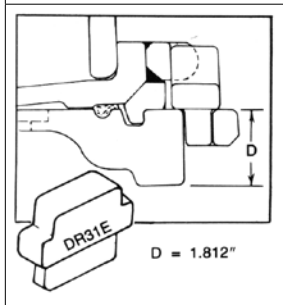
 <p>The DR31C driver key is used on rim bases with 1.0" and 1.3" approximate thickness gutter sections; basic styles STM, HTM, HTHM and HTHL.</p> <p>D = 1.031 for STM & HTM Gutter D = 1.343 for HTH Gutter</p>	
 <p>The DR31E driver key is used on rim bases with the 1.8" approximate thickness gutter section; basic style HTEL.</p> <p>D = 1.812"</p>	

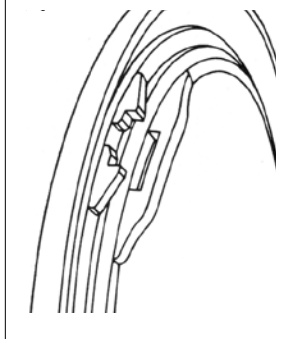
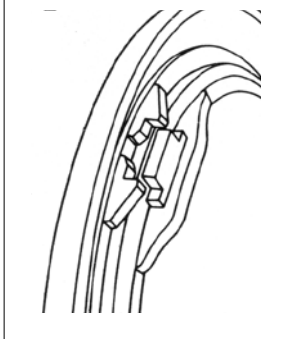
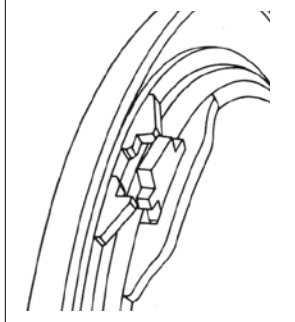
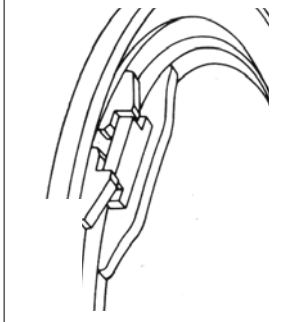
<p>1. Align driver pockets in bead seat band and base.</p> 	<p>2. Inset driver key into driver pocket on base.</p> 
<p>3. Make certain all parts are aligned properly, as shown, before inflation.</p> 	<p>4. The bead seat band and pocket will move out and lock the driver key during inflation.</p> 

5.1.2 Titan "W" Series Rims

ALWAYS check part numbers carefully before rim assembly. Titan's "W" series lock rings are **NOT INTERCHANGEABLE** with other types.

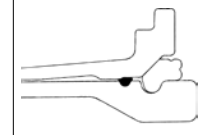
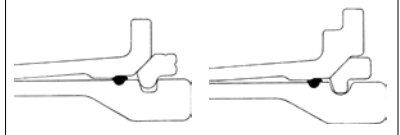
<p>Correct Assembly:</p> <p>"W" style lock ring with grooves assembled with "W" style rim base.</p> 	<p>Examples of Improper Assembly:</p> <p>DO NOT USE a "W" lock ring with old rim base or an older lock ring with "W" style rim base. Both will have poor fit and a gap between lock ring and gutter.</p> <p>ALWAYS reassemble using proper components.</p> 
---	---

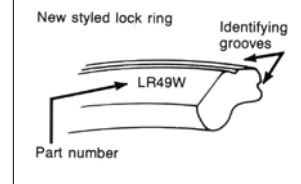
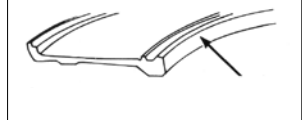
<p>"W" Style Lock Ring</p> <p>A "W" appears after the part number, which is stamped on the 45 degree face near the lock ring split (e.g. LR49W for a 49" rim). A circumferential groove gives the ring a unique appearance. This lock ring can only be used with the new "W" style gutters.</p> 	<p>"W" Style Rim Base</p> <p>There are two types of rim bases: older versions contain a "T" in the part number and newer versions contains a "W." A caution is stamped on the faces of the "W" style rim base to only use with a "W" style lock ring.</p> <table border="0"> <tr> <td>OLD B1735HTHGD B3239HTEL</td> <td>NEW B1735RWHGD B3239RWEL</td> </tr> </table> 	OLD B1735HTHGD B3239HTEL	NEW B1735RWHGD B3239RWEL
OLD B1735HTHGD B3239HTEL	NEW B1735RWHGD B3239RWEL		

Bead Seat Bands

There are two types of bead seat bands: older versions contain an "H" in the part number and newer versions contain an "R." The R and H Bead Seats are interchangeable.

OLD BB49HTG BB39HTL	NEW BB49RTG BB28RTL
---------------------------	---------------------------

5.2 Demounting

Tools Required

If ON vehicle: Lifting device or boom truck, hydraulic bead unseating tool, gooseneck tire iron, straight tire iron, wire and valve core removal tool.

If OFF vehicle: Hydraulic bead unseating tool, two (2) straight tire irons, valve core removal tool, wire and a screwdriver.

If ON vehicle	If OFF vehicle
1. Jack, crib and block the vehicle/equipment per the manufacturer's instructions.	1. Place the assembly gutter side up on blocks.

CONTINUES ON NEXT PAGE

If ON vehicle	If OFF vehicle
2. Always completely deflate tire (and both tires of a dual assembly) by removing valve core(s) from valve(s). Check the valve stem by running a piece of wire through the stem to make sure it is not plugged.	2. Always completely deflate tire by removing valve core from valve. Check the valve stem by running a piece of wire through the stem to make sure it is not plugged.
3. Place the hook of the hydraulic demounting tool into one of the pry bar pockets. A continuous lip is provided on some bases. Adjust the ram adjusting screw to enable the tool to be perpendicular to the wheel when under pressure.	3. Remove the lock ring, using two tire irons. NOTE: If this is not possible, the tire bead may be unseated as shown in step 4 with the lock ring and "O" ring in place. These items must be removed before removal of bead seat bands and flanges in step 7.
4. Apply pressure and depress the flange about 3/4." If necessary, release the pressure to readjust the tool. Place the end of the gooseneck tire iron between the flange and the lip of the bead seat band and release the pressure. Then place the hook of the hydraulic demounting tool under the lip of the bead seat band and continue the procedure around the rim; then slowly apply pressure until the tire bead is COMPLETELY unseated.	4. Remove the "O" ring by prying the bead seat band back and inserting a pry bar or screwdriver under the "O" ring and pulling it from the groove. ALWAYS cut and discard the "O" ring and replace with a new "O" ring.
5. Remove Driver Key if present – see Driver Key	5. Place hook of the hydraulic demounting tool into one of the pry bar pockets. A continuous lip is provided on some bases. Adjust the ram adjusting screw to enable the tool to remain vertical when under pressure. In some cases, the pressure foot may have to be removed to ensure a good hold. If necessary, release pressure and readjust the ram adjusting screw. Depress flange about 1/2"-3/4" and place a nut or similar object between the flange and the lip of the bead seat band by laying it on the rim flange and sliding it into position with a screwdriver.
6. Remove the lock ring with a pry bar, starting near the split and working around the ring.	6. Release the pressure and move about 2 feet around the rim or to the next pocket for the second bite. Continue the procedure until the tire bead is unseated. Do not use tool in the vicinity of the butt weld area of the bead seat band, the flanges, or rim base.

If ON vehicle	If OFF vehicle
7. Remove the "O" ring by prying the bead seat band back and inserting a pry bar or screwdriver under the "O" ring and pulling it from the groove. ALWAYS cut and discard the "O" ring and replace with a new "O" ring.	7. Remove bead seat band using hoist or pry bars.
8. Use a gooseneck tire iron under the flange to pry the bead seat band loose, with assistance of lifting device, carefully lower the bead seat band to the ground and roll it out of the way.	8. Remove outer flange using a hoist or pry bars.
9. With assistance or a lifting device, remove the outer flange, then carefully lower it to the ground and roll it out of the way.	9. Turn assembly over and repeat tire bead unseating procedure on the back-side. (Steps 4 & 5)
10. To unseat the inner tire bead, use either the hydraulic demounting tool as used on the outer bead or a shorty ram between the frame of the vehicle and the back flange.	10. Lift rim base from tire using hoist.
11. Remove the tire using a boom truck and sling or a tire handler. Remove the inner flange to complete the disassembly.	11. Remove inner flange. NOTE: You may want to use a more powerful hydraulic demounting tool with a longer stroke. Use caution to avoid bending the flange or breaking the butt weld. Follow procedure outlined in step 5.

5.3 Mounting



To prevent **SERIOUS INJURY** or **DEATH**:

- **ALWAYS** check the tire matches the rim diameter designation. **NEVER** mount a tire that is too large or too small for the rim. Rims of different diameters and tapers **CANNOT** be interchanged.
- **ALWAYS** remove water and foreign material from tire.
- **INSPECT** rim for damage, pitting from corrosion, cracks or if bent out of shape. If damage is found, **DO NOT** use. Mark or tag as unserviceable and remove from service area.

Tools Required

Lifting device or boom truck, One (1) straight tire iron, two (2) gooseneck tire irons, approved tire lubricant, rubber mallet, extension hose with in-line gauge and clip-on air chuck, air/water inflation gauge, tire cage or other approved restraining devices.

1.	Use a wire brush to clean the rim base and all components thoroughly. Clean all dirt and rust from inter-locking faces of multi-piece rim components, particularly the gutter sections that hold the lock ring and "O" ring in place.
----	---

CONTINUES ON NEXT PAGE

2.	<p>Inspect rim base and wheel components for cracks, wear, corrosion and damage.</p> <div style="display: flex; align-items: flex-start;"> <div style="margin-right: 10px;">  </div> <ul style="list-style-type: none"> If damage is found, DO NOT use. Mark or tag as unserviceable and remove from service area. Inspect all wheel components to verify the components meet the manufacturer's standards. Replace any cracked, badly worn, damaged and severely rusted parts and rims. Do not attempt to rework, weld, heat, or braze any rim base or wheel components under any circumstances. </div> <p>Verify the replacement parts are the correct size, type and manufacturer for the wheel to be assembled.</p>
----	--

If ON vehicle	If OFF vehicle
	<p>8. Start the lock ring in the lock ring groove and push or walk it into place. When a driver key is used, make sure the gap in the lock ring is at least 6" away from the driver key.</p>
	<p>9. Insert Driver Key as required in pockets.</p>

For ON and OFF vehicle

Place rim and tire in a tire cage or other approved restraining devices during tire inflation. Use a clip-on chuck with an in-line pressure gauge and enough hose so you can stay away from the potential trajectory danger zone.

WITH VALVE CORE REMOVED: Inflate to approximately 3 psi and check for proper engagement of all components.

If assembly is correct, install valve core and inflate to recommended pressure.

If assembly is incorrect, STOP – DEFLATE – CORRECT THE ASSEMBLY – AND REPEAT PROCEDURE.





Never attempt to align or seat side flange, lock ring or other components by inflation, hammering, welding, heating or brazing.

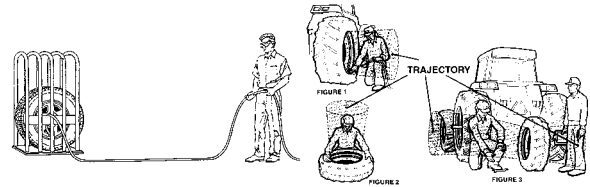

Never inflate beyond manufacturer's recommended tire pressure.

Then remove tire cage or other approved restraining devices.



If ON vehicle	If OFF vehicle
<p>3. Position the outer flange on the rim base with the help of the boom.</p>	<p>3. Place rim base on blocks (4" to 6" high) on floor, gutter side up. Place inner flange on rim base and lubricate tire beads. Place tire on rim using tire handler or hoist with sling.</p>
<p>4. Place the bead seat band on the rim base with the help of the boom. Be sure driver pocket on bead seat band lines up with pocket on rim base.</p>	<p>4. Depress the tire so the lower tire bead is driven onto the back 5° Bead Seat taper on the rim. This will expose more of the gutter at the upper side of the rim base.</p>
<p>5. Use the boom to hold the rim components out of the way. Place a new, lubricated "O" ring into the "O" ring groove, then lubricate the entire "O" ring area with diluted tire lubricant. Snap "O" ring into place by placing in groove on one side, stretching like rubber band and seating on opposite side.</p>	<p>5. Place the outer flange over the rim base on the tire.</p>
<p>6. Start the lock ring in the lock ring groove and push or walk it into place. When a driver key is used, make sure the gap in the lock ring is at least 6" away from the driver key.</p>	<p>6. Place the bead seat band on the rim base. If present, driver pockets must be aligned. Due to limited clearance between bead seats and rim base, bead seat band will bind if cocked slightly. Band should slide freely over base.</p> <div style="text-align: center;">  <p>DO NOT hammer bead seat band into place!</p> </div> <p>If necessary, remove and re-install, or use mallet to tap, lightly upward on the bead seat band to seat properly.</p>
<p>7. Check components (lock rings, bead seat and flanges) to make sure the parts are correctly assembled. NOTE: Lock rings should be fully seated in gutter around the circumference. Insert Driver Key – see Driver Key section.</p>	<p>7. Place a new, lubricated "O" ring into the "O" ring groove, then lubricate the entire "O" ring area with diluted tire lubricant. Snap "O" ring into place by placing in groove on one side, stretching like rubber band and seating on opposite side.</p>

6. Additional Resources

Occupational Safety and Health Administration (OSHA), <https://www.osha.gov/>

- 29 CFR 1910.177, Servicing of Single Piece and Multi-Piece Rim Wheels
- Demounting and Mounting Procedures for Tube-type Truck and Bus Tires Chart – Tire Chart (OSHA 3402)
- Demounting and Mounting Procedures for Tubeless Truck and Bus Tires Chart – Tire Chart (OSHA 3401)
- Multi-Piece Rim Matching Chart – Tire Chart (OSHA 3403 - 2011)
- Servicing Multi-Piece and Single – Piece Rim Wheels 29 CFR 1910.177 Manual – Tire Chart (OSHA 3421 - 2014)

U.S. Tire Manufacturers Association, <https://www.ustires.org/publications>

- Care and Service of Commercial Truck and Bus Tires
- Demounting and Mounting Procedures for Passenger and Light Truck Tires Wall Chart

Tire Industry Association, <https://www.tireindustry.org>

- Basic Earthmover Tire Service (ETS) Training Kit
- Basic Farm Tire Service Training Kit
- OTR Tire Mount/Demount Training Program

➤ **TITAN MOVES THE WORLD.®**



1 (800) 872-2327 | www.titan-intl.com/

TITAN MOVES THE WORLD®
070T01EN012024 © 2024 Titan International, Inc. All trademarks are owned by Titan International, Inc. other than the trademark GOODYEAR and the winged foot logo, which are owned by The Goodyear Tire & Rubber Company. Materials and specifications are subject to change without notice.